

GENERAL CATALOGUE

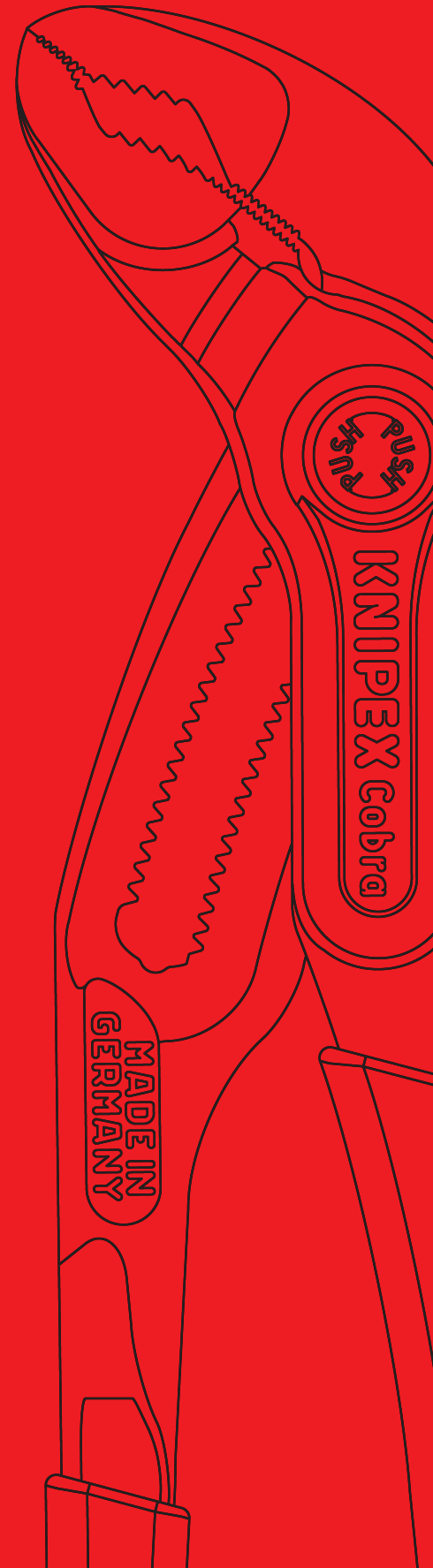

Pliers

MADE IN GERMANY SINCE 1882



The pliers company

KNIPEX Quality – Made in Germany



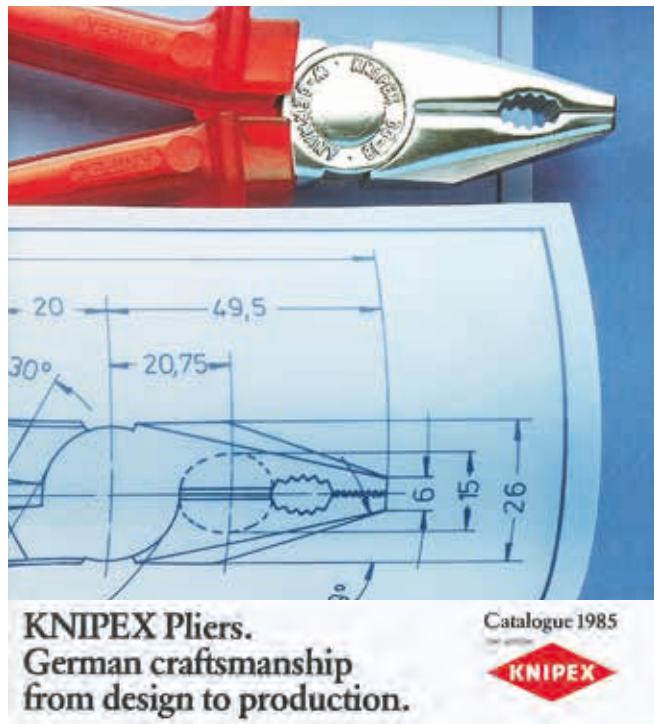
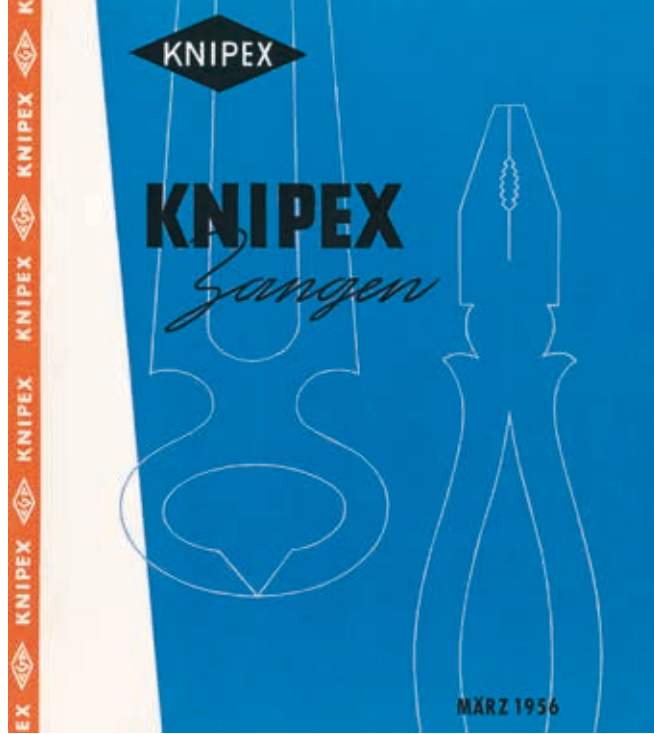

KNIPEX – the company behind the pliers.

For over 130 years and four generations, we have been working passionately on being the best manufacturer of pliers for our customers and users – with a clear focus, high demands and a constant flow of new ideas. Throughout the world, our brand enjoys a great deal of trust, and we aim to consistently meet and rebuild this.

Success is important to us, but is not something we look for at any price. We are guided by values, orientate our actions towards sustainability, and face up to our responsibility towards society and the natural environment in which and with which we live. We invest heavily in the efficiency of our location and the qualification of our employees, working today on the success of tomorrow and the day after that – so that we can also continue to be a strong and reliable partner in the future.

Yours, *Ralf Putsch*



Ralf Putsch, Managing Partner.

1



CoBolt® XL

2



Cobra®

3



Pliers for Electrical Installation

4



X-Cut®

5

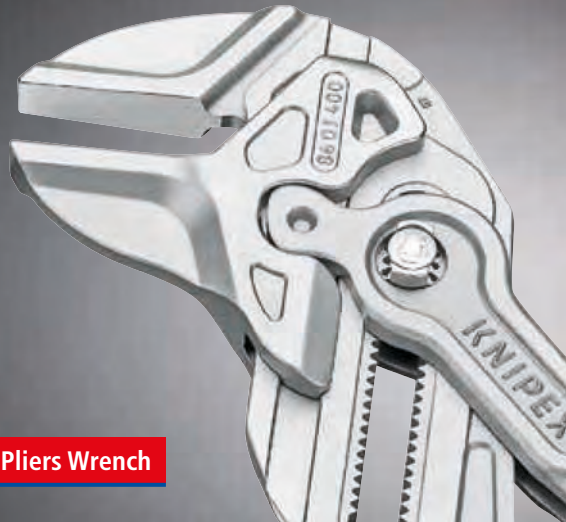

Pliers Wrench

6



TwinForce®

7



Bolt End Cutting Nippers

8



Spring Hose Clamp Pliers

KNIPEX pliers are different: ideas for more use and performance.

Ever better pliers – that is our guiding principle to which we devote all of our expertise and creativity. We are not satisfied with standard solutions, but rather continuously develop new and improved models that are better to work with and easier to use.

Working in this way means that sometimes we find unconventional solutions to situations, which then go on to set new benchmarks in the industry: novel methods of power transmission, easier and faster handling, combining various functions in a single tool and imaginative problem solvers for special applications. These save our users energy and time, giving them better work results with less effort.

In addition to major innovations, we work continuously on reworking our models in lots of small steps to improve their function, ergonomics and service life.

- 1 Compact force:** CoBolt® XL – two-hand operation for maximum cutting force.
- 2 Easy operation:** Cobra® – fast grip, precise adjustment, hold with self-locking.
- 3 Multifunctional:** electrical installation pliers – six functions in one pair of pliers.
- 4 Universal cutting force:** X-Cut® – the first high leverage diagonal cutters with box joint and precision cutting edges.
- 5 Speed and versatility:** pliers wrench – screws, holds, bends and presses without damaging materials.
- 6 High performance cutting edges:** TwinForce® – high strength thanks to unique transmission.
- 7 End cutting nippers – redefined:** bolt end cutting nippers – light, slim, cut directly on the pivot point.
- 8 Problem-solver:** spring hose clamp pliers – the only pliers for all clamps; apply safely from all angles.

Step by step: from idea to product.

A large number of steps lie between an initial idea and the finished product. We never lose sight of the fact that every new or further development must represent a noticeable improvement for the user. We deploy the most up to date technologies and processes when putting our ideas into practice.

We begin by carefully establishing the requirements and selecting the best concepts. The tool is constructed on a computer, and the function is simulated with the help of special software. This is followed by the first models made on a 3D printer and by milling and extensive tests on steel prototypes – naturally in close dialogue with experienced users. The first products manufactured using series production processes are subjected to further extensive tests – under conditions far more stringent than normal load.



The locking mechanism on the spring hose clamp pliers permit simple and safe work, even with closed clamps. Modern CAD technology simulates the mechanism on the screen.

The image features a man, Filip Marovic, sitting at a white table and holding a red and blue KNIPEX tool handle. He is wearing a light blue button-down shirt. Behind him is a large technical drawing of the tool handle, showing various dimensions and the KNIPEX logo. The drawing includes measurements such as 1.0, 2.0, 10.00, 20.74, 26.34, 26.00, 6.00, 26.14, and 3. The KNIPEX logo is prominently displayed on the handle. The background is a light blue wall with the KNIPEX logo visible on the right side.

Filip Marovic, project manager for KNIPEX Product Development – “It can be seen repeatedly during the development cycles how important even the smallest detail can be. This is the very thing that motivates me to find creative new solutions. During the process we also take new technical possibilities in processing technology and materials into consideration.”

Core qualities: steel – and what we make from it.

You can expect a great deal more from a pair of KNIPEX pliers. This starts with the material. Because the many models of pliers in our range are designed for different requirements and loads, we use steel alloys that have been specially selected for the application and rolled according to our high specifications. Long lasting cutting capability when working with very hard wires, strength when working with high torque loads, and good resistance to corrosion are examples of these targets.

The respective materials are then given their specific molecular structure in a number of coordinated heat treatment steps to produce the optimal relationship between hardness and toughness. These processes allow us to achieve the high degree of reliability, durability and service life that are the very definition of KNIPEX pliers.

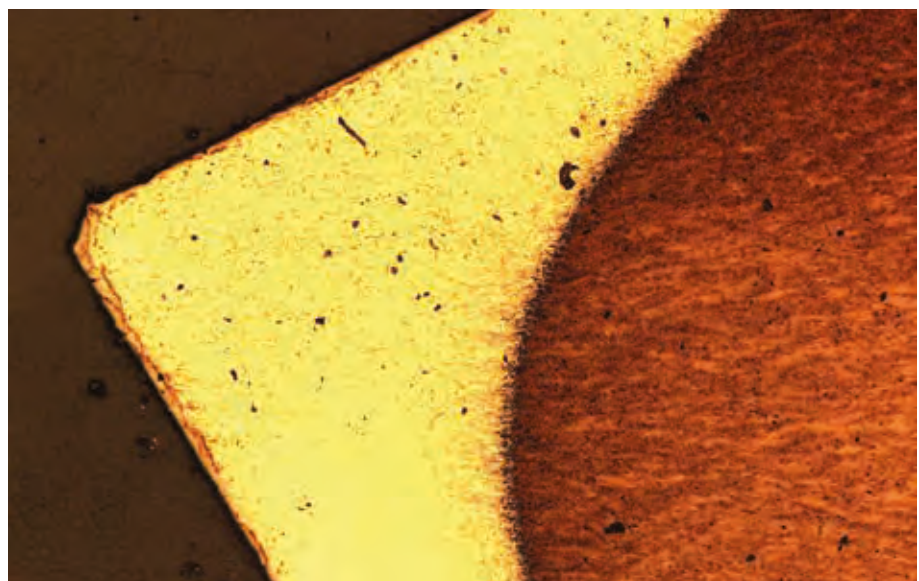

Macro image of a cutter after induction hardening. The specially hardened cutter area (light) is in sharp contrast to the softer structure of the body of the pliers (dark).

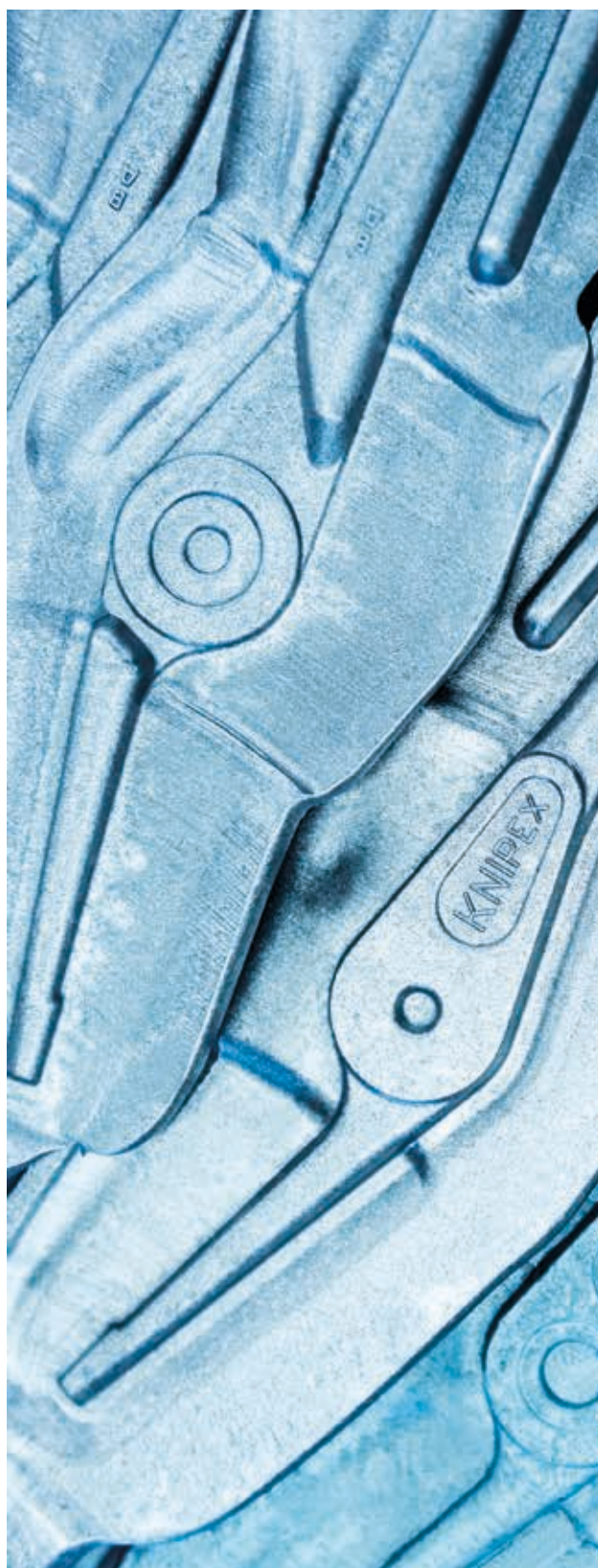

Handles of the "Alligator®
water pump pliers" being
forged under the hydraulic
double-acting hammer.



This is how our pliers are given their shape: hot and under high pressure.

Forging as a forming process is an old cultural technique and continues to hold fascination today. With an impact of up to five tonnes, the yellow glowing piece of steel is pounded in the upper and lower die at a temperature of 1,250°C. This gives it its basic shape and simultaneously a well-compacted structure.

The production of the forging die in our toolmaking works requires a great deal of experience and high precision, as this raw component will be crucial to the subsequent quality of the pliers. The contours of the forged component are milled at processing centres in the hardened and high strength die block.



Forging die for the high leverage diagonal cutters with forged-in axle.

The technology behind the pliers: machines made by KNIPEX.

All tools can only be as good as the production technology used to manufacture them. In other words, there can be no superior products without advances in production processes.

Due to our specialisation, we can focus on the technologies needed to produce high quality pliers efficiently. We have more than 400 machines, built with the specialised knowledge of generations. We build many of the machines ourselves or adapt machines precisely to our high standards using components we have manufactured. We even programme the software for the control and operation of the machinery ourselves in many cases.

From the product idea to the despatch of the finished pliers to our customers: everything is done under one roof. In this way we can directly influence all steps of value creation ourselves in terms of quality and efficiency, and make continuous improvements. Short paths and direct dialogue simplify coordination of processes and communication between employees.

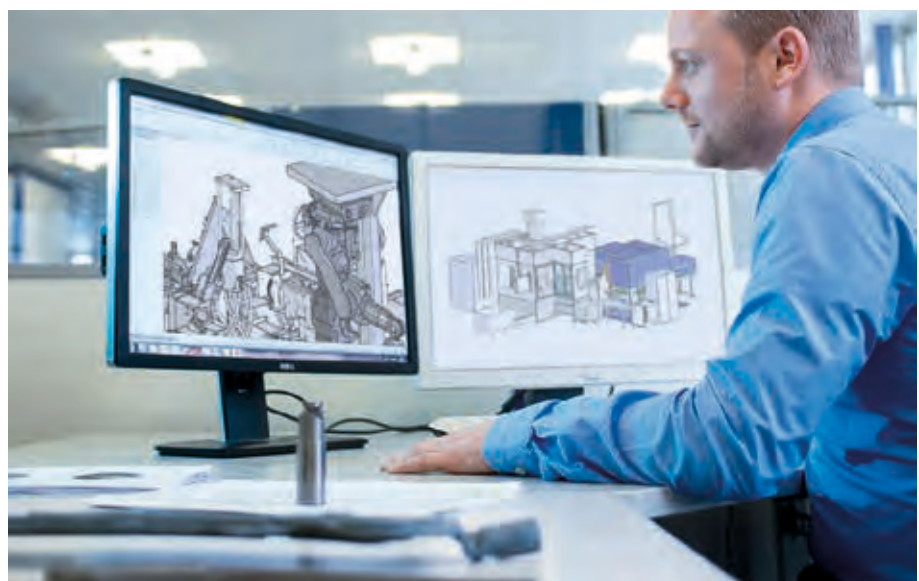

We ensure our high standards by developing our own processes and machinery.

A wide-angle photograph of a modern industrial factory floor. In the foreground, a worker in a dark blue uniform is operating a large orange robotic arm. The background is filled with complex machinery, conveyor belts, and structural beams, creating a sense of a busy, large-scale manufacturing environment. The lighting is bright and even, highlighting the metallic surfaces and the organized layout of the production area.

Efficiently coordinated
processes and machinery.

Over 45,000 pairs
of different models of
pliers leave our factory
every day.

Only after several test cuts, does a pair of KNIPEX cutting pliers leave our factory.

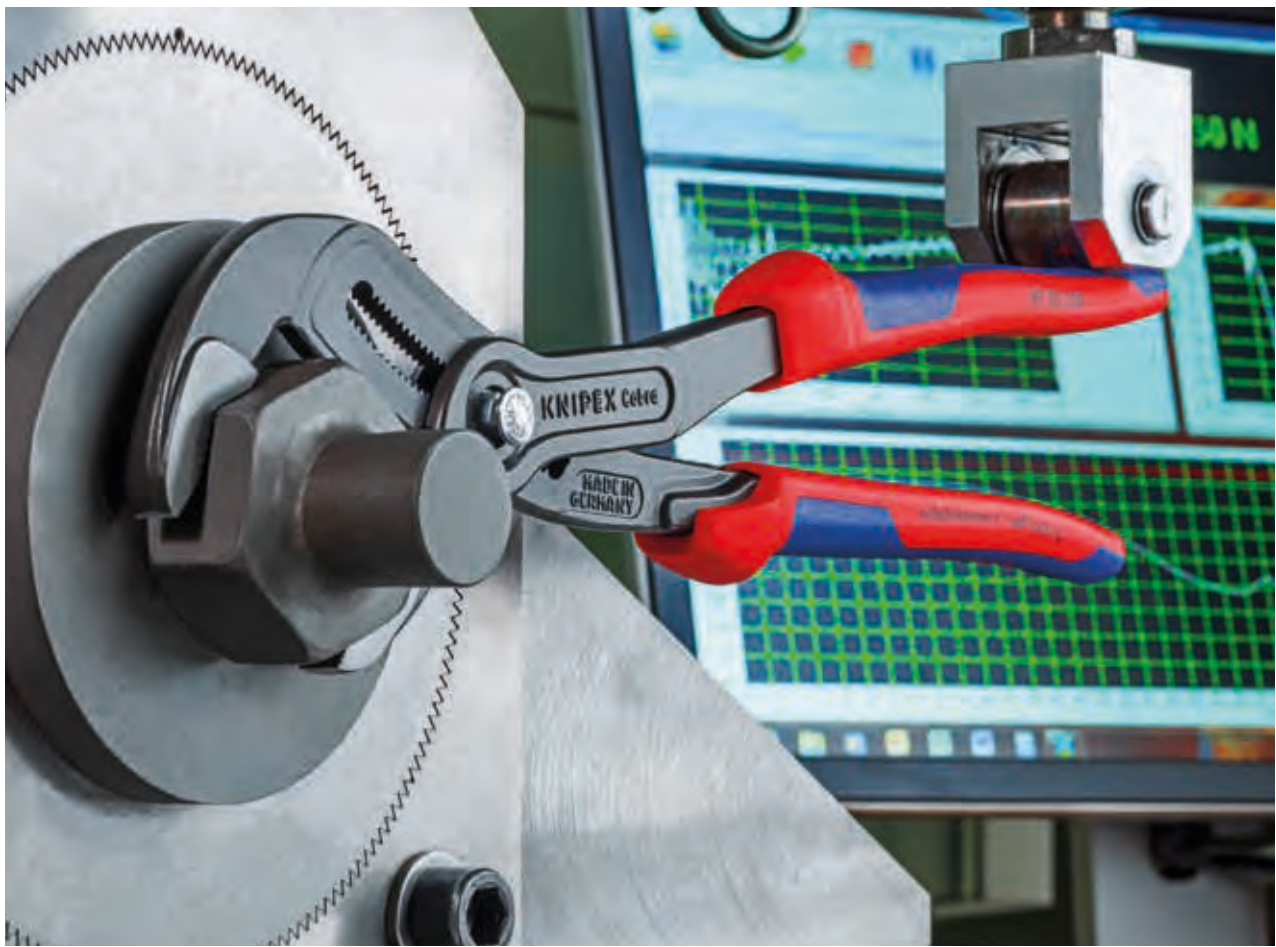
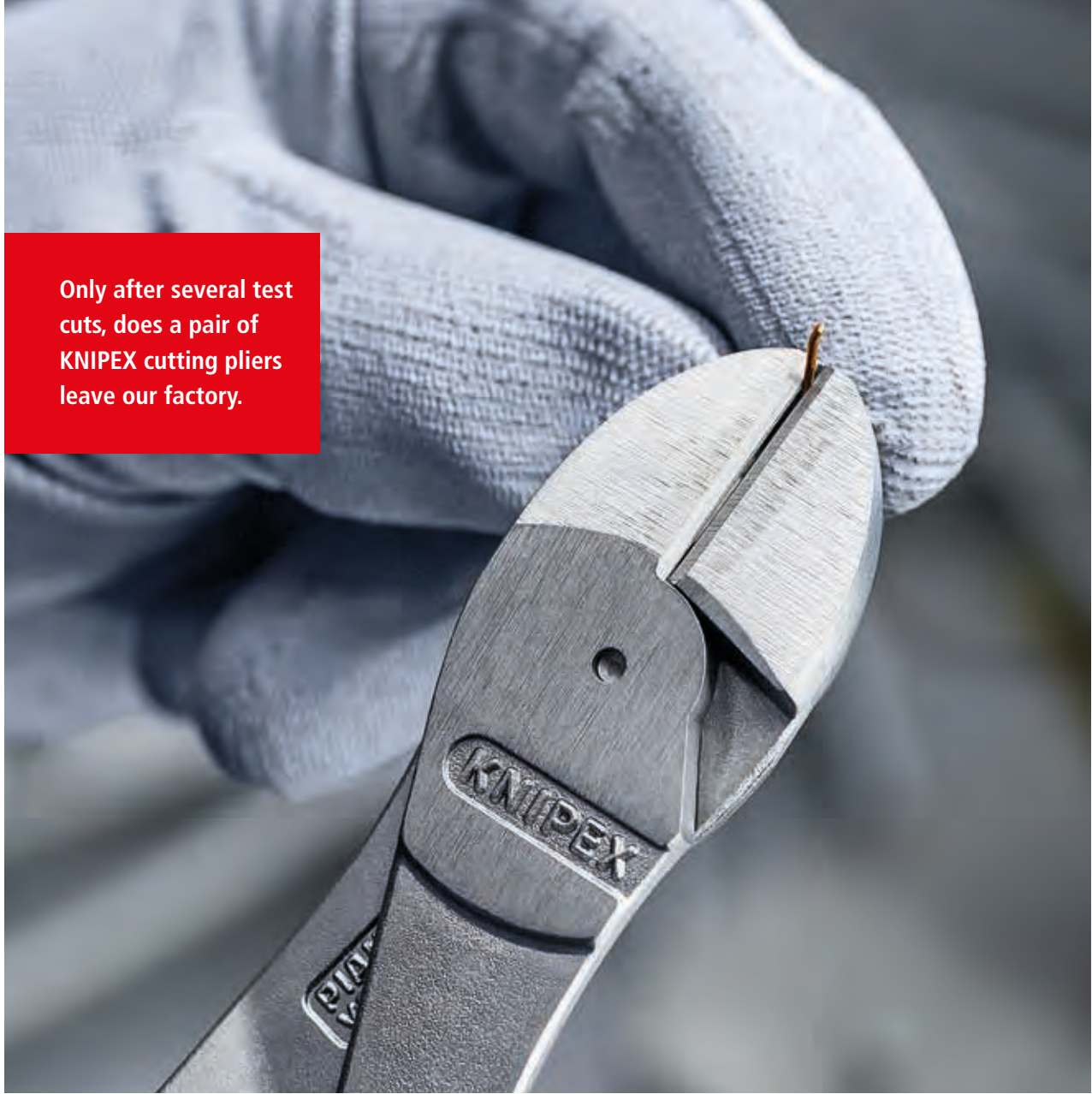

We take it very literally: 100% reliability.

The precision of pliers is essential for their function: without accuracy there can be no reliable cutting, gripping and shaping, and also no zero backlash. The tight tolerances, which we make sure are complied with through the use of modern production technology, enable us to meet our stringent quality specifications.

We ensure compliance through strict measurements and diverse inspections – both after the various production steps and at the end of the entire process. To do this we use the most up-to-date measurement technology and endurance test plants – as well as the practical component test by hand.



Shape and roughness of the diagonal cutter's cutting edge are precisely measured with an optical 3D measuring system.

More than excellent pliers: what else you can expect from us.

Quality does not stop with the product. Trust, reliability and a collaborative approach define our business relationships – with consistent customer orientation, good service and competent field staff. We provide advice and training, and supply you with extensive digital product data whose format we adapt to your specific requirements. Added to this are diverse possibilities for sales support.

You will not find the breadth and depth of our range with any other manufacturer worldwide – so that your customers can always find the tool they are looking for.



We also present the breadth and depth of our range at in-house exhibitions and open days.

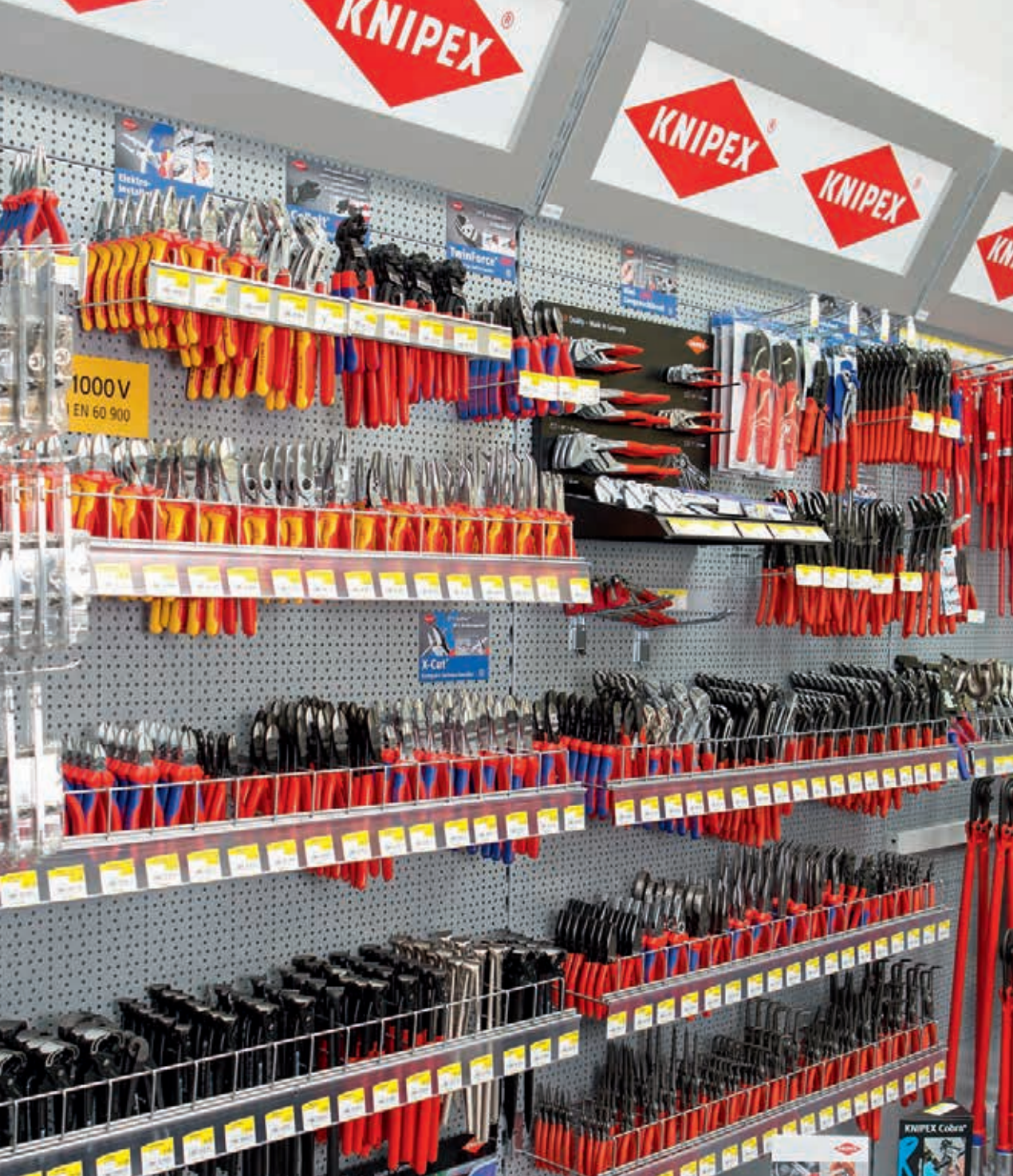



At home in the world: locations in more than 100 countries for you.

KNIPEX is the global pliers brand. We are present in all continents, with a dense network of customers, representatives and branches. In order to be closer still to our retailers and be able to give them even better support, we are further extending our international activities all the time.

There is no substitute for direct contact, which is why we are there for you personally at more than 100 trade fairs each year. On platforms and with the help of the most varied media – classic and digital – we provide comprehensive information about our range and application opportunities in over 30 languages. We reach users and fans throughout the whole world via social media and hundreds of KNIPEX online videos.



We make up to date information available digitally in several languages on all usual channels.

The key factor: our employees.

The most important basis of our success is our employees. Their knowledge and skills, their dedication and their ideas are crucial to our efficiency and thus to our future.

As a company, we are a social community. We want to shape our culture in such a way that allows our employees to participate and identify through their work but also as individuals. We create good conditions for our employees to develop their potential, to obtain further qualifications and to stay healthy. It is also important to us that our employees are able to successfully balance family and career

We invest a significant amount of both expense and care in the training of young people, but also impart a wide spectrum of professional and personal skills to other employees.



Our junior staff obtain their qualifications in our own modern training workshop.





Acting responsibly – sustainable management.



As a company, we believe we share responsibility for our natural environment and the well-being of society. We interact with both in various ways. We consume resources, but take care to use them as carefully as possible, and want to make a contribution to ensuring that they are available to future generations in the same or where possible a better form.

Our ecological objectives include a continuous reduction in our energy consumption, reduction in the volumes of waste and caring for the biodiversity at our site. In addition, we participate in major climate protection projects.

Companies should also be good citizens. We support numerous institutions and organisations from the areas of education and culture. We maintain a close exchange with schools and universities, and strengthen civic engagement in our region in diverse ways.



We support the Bergische music school in the “Singpause” project which, with the help of specially trained teachers, communicates the foundations of music and pleasure at singing together in schools.

At a glance

Overview of products

2	Combination and Multifunctional Pliers	
	Combination Pliers Pliers for Installation Round Nose and Flat Nose Pliers	
18	Wire Strippers and Dismantling Tools	
	Insulation Strippers with adapted blades MultiStrip 10 Dismantling Tools	
44	Gripping and Grip Pliers	
	Flat Nose Pliers Round Nose Pliers Grip Pliers	
56	Circlip Pliers	
	Circlip Pliers Precision Circlip Pliers Circlip Pliers Sets	
72	Carpenters' Pincers and Concreters' Nippers	
	Carpenters' Pincers Concreter's Nippers High Leverage Concreters' Nippers	
78	Cutting Pliers	
	Diagonal Cutters Bolt Cutters End Cutting Nippers	
102	Pipe Wrenches and Water Pump Pliers	
	Pliers Wrenches Cobra® Alligator® Pipe Wrenches	
124	Special Pliers and Control Cabinet Keys	
	Pipe Cutters Spring Hose Clamp Pliers Magnetic LED Lamp Control Cabinet Keys	
146	Cable and Wire Rope Shears	
	Cable Shears Cable Cutters with ratchet action Wire Rope Shears	
162	Crimping Pliers and Crimp Assortments	
	Crimp System Pliers PreciForce® Cable Connectors	
194	Insulated Tools	
	Pliers Wrenches Screwdrivers Sets	
238	Electronics Pliers and Precision Tweezers	
	Cutting Pliers Gripping Pliers Precision Tweezers	
262	Pliers with tether attachment point for mounting a fall protection	
268	Tool Assortments and Tool Cases	
	Pliers Sets Tool Bags Tool Cases	
330	Index / Article Number Index Pliers-ABC	



Combination and
Multifunctional Pliers

Combination Pliers	4
High Leverage Combination Pliers	5
Needle-Nose Combination Pliers	6
Mini Combination Pliers	8
“Lineman’s Pliers” American style	9
Pliers for Electrical Installation	10
Electricians’ Pliers	12
Round Nose Pliers with cutting edge (Jewellers’ Pliers)	13
Flat Nose Pliers with cutting edges (Precision Mechanics Pliers)	14
Snipe Nose Pliers with centre cutter (Telephone Pliers)	14
Snipe Nose Side Cutting Pliers (Radio Pliers)	15
Snipe Nose Side Cutting Pliers (Stork Beak Pliers)	16

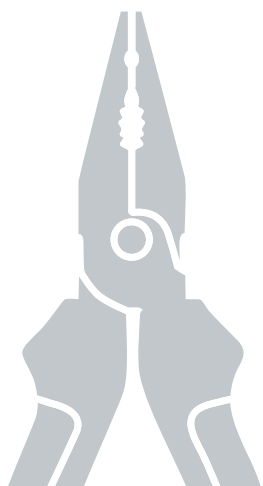

Combination Pliers

- > With gripping zones for flat and round material, suitable for versatile use
- > With cutting edges for soft and hard wire
- > Long cutting edges for thicker cables
- > Cutting edges additionally induction-hardened, cutting edge hardness approx. 60 HRC
- > Special tool steel, forged, multi stage oil-hardened
- > DIN ISO 5746

03 06 180 T*

- > Pliers with tether attachment point for mounting a fall protection

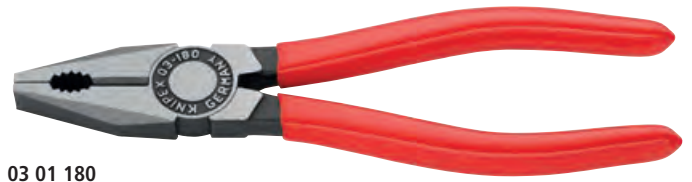

03 01 180



03 02 180



03 05 180



03 06 180 T



03 07 200

Article No.	EAN 4003773-	↔ mm	Pliers	Head	Handles	Cutting capacities				
						Ø mm	Ø mm	Ø mm	mm ²	Δ g
03 01 140	015192	140	black atramentized	polished	plastic coated	2.8	1.8	9.0	10	106
03 01 160	013235	160				3.1	2.0	10.0	16	187
03 01 180	013242	180				3.4	2.2	12.0	16	216
03 01 200	013259	200				3.8	2.5	13.0	16	276
03 01 250	015222	250				3.8	2.5	15.0	25	480
03 02 160	023203	160	black atramentized	polished	with multi-component grips	3.1	2.0	10.0	16	223
03 02 180	023197	180				3.4	2.2	12.0	16	254
03 02 200	034940	200				3.8	2.5	13.0	16	322
03 05 140	039730	140	chrome plated	chrome plated	with multi-component grips	2.8	1.8	9.0	10	139
03 05 160	039518	160				3.1	2.0	10.0,0	16	222
03 05 180	034933	180				3.4	2.2	12.0	16	254
03 05 200	041146	200				3.8	2.5	13.0	16	324
03 06 160	021902	160	chrome plated	chrome plated	insulated with multi-component grips, VDE-tested	3.1	2.0	10.0	16	228
03 06 180	021926	180				3.4	2.2	12.0	16	264
03 06 200	033776	200				3.8	2.5	13.0	16	355
03 06 180 T	081395	180	chrome plated	chrome plated	insulated with multi-component grips, VDE-tested, with integrated tether attachment point for a tool tether	3.4	2.2	12.0,0	16	270
03 07 160	015307	160	chrome plated	chrome plated	with dipped insulation, VDE-tested	3.1	2.0	10.0	16	254
03 07 180	015314	180				3.4	2.2	12.0	16	285
03 07 200	015321	200				3.8	2.5	13.0	16	339
03 07 250	015345	250				3.8	2.5	15.0	25	597

High Leverage Combination Pliers

- ▶ 35 % less effort required than with conventional combination pliers
- ▶ With cutting edges (hardness approx. 63 HRC) for heavy duty

- > Easier work due to optimised leverage
- > Easier cutting, powerful gripping, bending and pulling
- > Long cutting edges for thicker cables
- > With gripping zones for flat and round material, suitable for versatile use
- > High-grade special tool steel, forged, multi stage oil-hardened
- > Cutting edges additionally induction-hardened, cutting edge hardness approx. 63 HRC
- > DIN ISO 5746

02 02 225 T*

- > Pliers with tether attachment point for mounting a fall protection



02 01 200



02 02 180



02 02 225 T



02 05 180



02 06 180



02 07 225

Article No.	EAN 4003773-	↔ mm		Pliers	Head	Handles	Cutting capacities				⚖ g
							Ø mm	Ø mm	Ø mm	mm ²	
02 01 180	033134	180		black atramentized	polished	plastic coated	2.5	2.0	11.5	16	202
02 01 200	039679	200		black atramentized	polished	plastic coated	2.8	2.2	13.0	25	298
02 01 225	013198	225		black atramentized	polished	plastic coated	3.0	2.5	14.0	25	355
02 02 180	034896	180		black atramentized	polished	with multi-component grips	2.5	2.0	11.5	16	240
02 02 200	034902	200		black atramentized	polished	with multi-component grips	2.8	2.2	13.0	25	342
02 02 225	043379	225		black atramentized	polished	with multi-component grips	3.0	2.5	14.0	25	405
02 02 225 T	079934	225		black atramentized	polished	with multi-component grips and integrated tether attachment point	3.0	2.5	14.0	25	410
02 05 180	043072	180		chrome plated	chrome plated	with multi-component grips	2.5	2.0	11.5	16	238
02 05 200	043089	200		chrome plated	chrome plated	with multi-component grips	2.8	2.2	13.0	25	342
02 05 225	010005	225		chrome plated	chrome plated	with multi-component grips	3.0	2.5	14.0	25	400
02 06 180	010012	180		chrome plated	chrome plated	insulated with multi-component grips, VDE-tested	2.5	2.0	11.5	16	247
02 06 200	010029	200		chrome plated	chrome plated	insulated with multi-component grips, VDE-tested	2.8	2.2	13.0,0	25	343
02 06 225	010036	225		chrome plated	chrome plated	insulated with multi-component grips, VDE-tested	3.0	2.5	14.0	25	401
02 07 200	022299	200		chrome plated	chrome plated	with dipped insulation, VDE-tested	2.8	2.2	13.0	25	380
02 07 225	022305	225		chrome plated	chrome plated	with dipped insulation, VDE-tested	3.0	2.5	14.0	25	486

Needle-Nose Combination Pliers

**Small High Leverage Combination Pliers with pointed jaw.
For all common installation and repair work.**

- ▶ Handy use when working in confined areas thanks to slim head design and pointed jaws (anti-twist)
 - ▶ Gripping surfaces with special convex contour on one side for secure gripping of flat parts
 - ▶ Milled groove in the gripping area permits small parts such as nails, pins and bolts to be held and pulled
- > The reliable and diverse combination pliers when out and about
 - > Easy cutting thanks to the high leverage joint
 - > With cutting edges for soft, medium-hard and hard wire
 - > Long service life and stable tips
 - > Forged from special high grade tool steel, manifold oil-hardened
 - > Cutting edges additionally induction-hardened, cutting edge hardness approx. 59 - 63 HRC
 - > DIN ISO 5746

08 22 145 T / 08 26 145 T*

- > Pliers with tether attachment point for mounting a fall protection



08 21 145



08 22 145



08 22 145 T



08 25 145



08 26 145



08 26 145 T



Firm grip also on flat material due to three-point rest



Milled groove in the gripping area



Tip keeps its shape even during greater torsional forces



Slim head for ideal accessibility



Article No.	EAN 4003773-	↔ mm		Pliers	Head	Handles	Cutting capacities				⚖ g
							● Ø mm	◐ Ø mm	⊕ Ø mm	⊕ mm ²	
08 21 145	078951	145		black atramentized	polished	plastic coated	3.0	2.0	8.0	16	116
08 22 145	078968	145		black atramentized	polished	with multi-component grips	3.0	2.0	8.0	16	145
08 22 145 T	080640	145		black atramentized	polished	with multi-component grips and integrated tether attachment point	3.0	2.0	8.0	16	150
08 25 145	078975	145		chrome plated	chrome plated	with multi-component grips	3.0	2.0	8.0	16	145
08 26 145	079361	145		chrome plated	chrome plated	insulated with multi-component grips, VDE-tested	3.0	2.0	8.0	16	145
08 26 145 T	081401	145		chrome plated	chrome plated	insulated with multi-component grips, VDE-tested, with integrated insulated tether attachment point for a tool tether	3.0	2.0	8.0	16	155

Combination Pliers

Chrome Vanadium

- > For heavy duty
- > With gripping zones for flat and round material, suitable for versatile use
- > With cutting edges for soft, hard and piano wire
- > Long cutting edges for thicker cables
- > Cutting edges additionally induction-hardened, cutting edge hardness approx. 64 HRC
- > Particularly wear resistant gripping jaws; hardness of the gripping jaws approx. 53 HRC
- > Chrome vanadium heavy-duty steel, forged, multi stage oil-hardened
- > DIN ISO 5746, DIN EN 60900, IEC 60900



01 06 160

Article No.	EAN 4003773-	↔ mm		Pliers	Head	Handles	Cutting capacities				
							Ø mm	Ø mm	Ø mm	mm ²	g
01 06 160	040729	160		chrome plated	chrome plated	insulated with multi-component grips, VDE-tested	2.0	1.5	10.0	16	220
01 06 190	040415	190					2.5	2.0,0	13.0	25	320

Mini Combination Pliers

- > Compact combination pliers for professionals and hobbyists
- > With gripping zones for flat and round material, suitable for versatile use
- > With cutting edges for soft and hard wire
- > Cutting edges additionally induction-hardened, cutting edge hardness approx. 60 HRC
- > Vanadium electric steel, forged, multi stage oil-hardened



08 05 110

Article No.	EAN 4003773-	↔ mm		Pliers	Head	Handles	Cutting capacities				
							Ø mm	Ø mm	Ø mm	mm ²	g
08 05 110	034957	110		chrome plated	chrome plated	with multi-component grips	2.5	1.6	9.0	10	85

Lineman's Pliers

American style

- ▶ High transmission ratio for easy cutting
- ▶ Requires 50 % less effort compared with conventional combination pliers thanks to optimised transmission ratio
- > Solid construction for heaviest strain; universally applicable
- > Ergonomically optimised handle shape for firm contact to the hand and fatigue reducing operation
- > Particularly effective cross-hatched knurled gripping zone in the jaws – for strong gripping and pulling
- > Additional gripping zone below the joint for powerful leverage and pressing performance
- > With cutting edges for soft and hard wire
- > Cutting edges additionally induction-hardened, cutting edge hardness approx. 64 HRC
- > Vanadium electric steel, forged, multi stage oil-hardened
- > DIN ISO 5746, ASME B107.20

09 02 240 T / 09 12 240 T*

- > Pliers with tether attachment point for mounting a fall protection

09 11 240 / 09 12 240 / 09 12 240 T*

- > With fish tape puller in the joint gap; with universal mandrel crimping point below the joint



09 01 240



09 02 240



09 02 240 T



09 11 240



09 12 240



09 12 240 T



09 11/12 240: fish tape puller in the joint gap





















Cross-hatched, knurled gripping zone for firm gripping and pulling, e. g. for fence construction



Long cutting edges for cutting flat cables



09 11/12 240: universal mandrel crimping area below the joint

Article No.	EAN 4003773-	↔ mm	 	Pliers	Head	Handles	Cutting capacities		 g
							 Ø mm	 Ø mm	
09 01 240	064992	240	 	black atramentized	polished	with non-slip plastic coating	4.6	3.0	435
09 02 240	065005	240	 	black atramentized	polished	with multi-component grips	4.6	3.0	470
09 02 240 T	079941	240	  	black atramentized	polished	with multi-component grips and integrated tether attachment point	4.6	3.0	463
09 11 240	071952	240	 	black atramentized	polished	with non-slip plastic coating	4.6	3.0	435
09 12 240	071969	240	 	black atramentized	polished	with multi-component grips	4.6	3.0	470
09 12 240 T	079958	240	  	black atramentized	polished	with slim multi-component grips, with integrated tether attachment point for a tool tether	4.6	3.0	455

*Other tools with tethering can be found from page 266

Pliers for Electrical Installation

The all-rounder for professionals

- ▶ 6 functions in one pair of pliers
- ▶ Multifunctional pliers for the electrical installation; to grip flat and round material, for bending, deburring, cutting cable, stripping and crimping wire ferrules
- > Smooth surfaces near the tips grip single cores without damaging them; serrated gripping surfaces and pipe grip for gripping flat and round material
- > Clear-cut outside edge on the gripping surfaces for working on flush-mounted junction boxes and deburring feed-through holes
- > Stripping holes for conductors of 0.75 - 1.5 mm² and 2.5 mm²
- > Crimping die for wire ferrules 0.5 - 2.5 mm²
- > Cable shears with (induction-hardened) precision cutting edges for copper and aluminium cables up to 5 x 2.5 mm² / dia. 15 mm
- > Slim dimensions for easy access
- > Bolted joint: precise, zero backlash operation of pliers
- > High-grade special tool steel, forged, multi stage oil-hardened

13 82 200 T / 13 96 200 T*

- > Pliers with tether attachment point for mounting a fall protection

13 91 200 / 13 92 200 / 13 96 200

- > In case of models with opening spring integrated in the joint, the activated locking lever keeps the cutting edges closed while other functions remain active; the intelligent latching mechanism enables you to "grip" without opening the pliers. The cutting edge remains closed and protected.

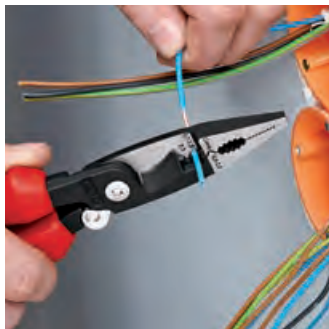
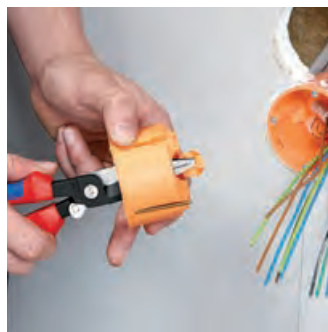

13 81 200



13 82 200



13 82 200 T



13 86 200



13 91 200



13 92 200



13 96 200

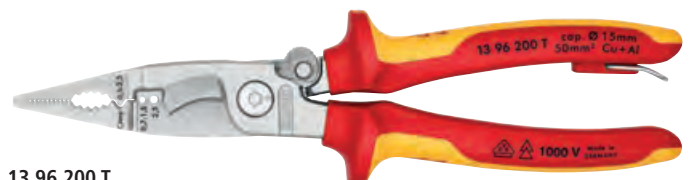

13 96 200 T

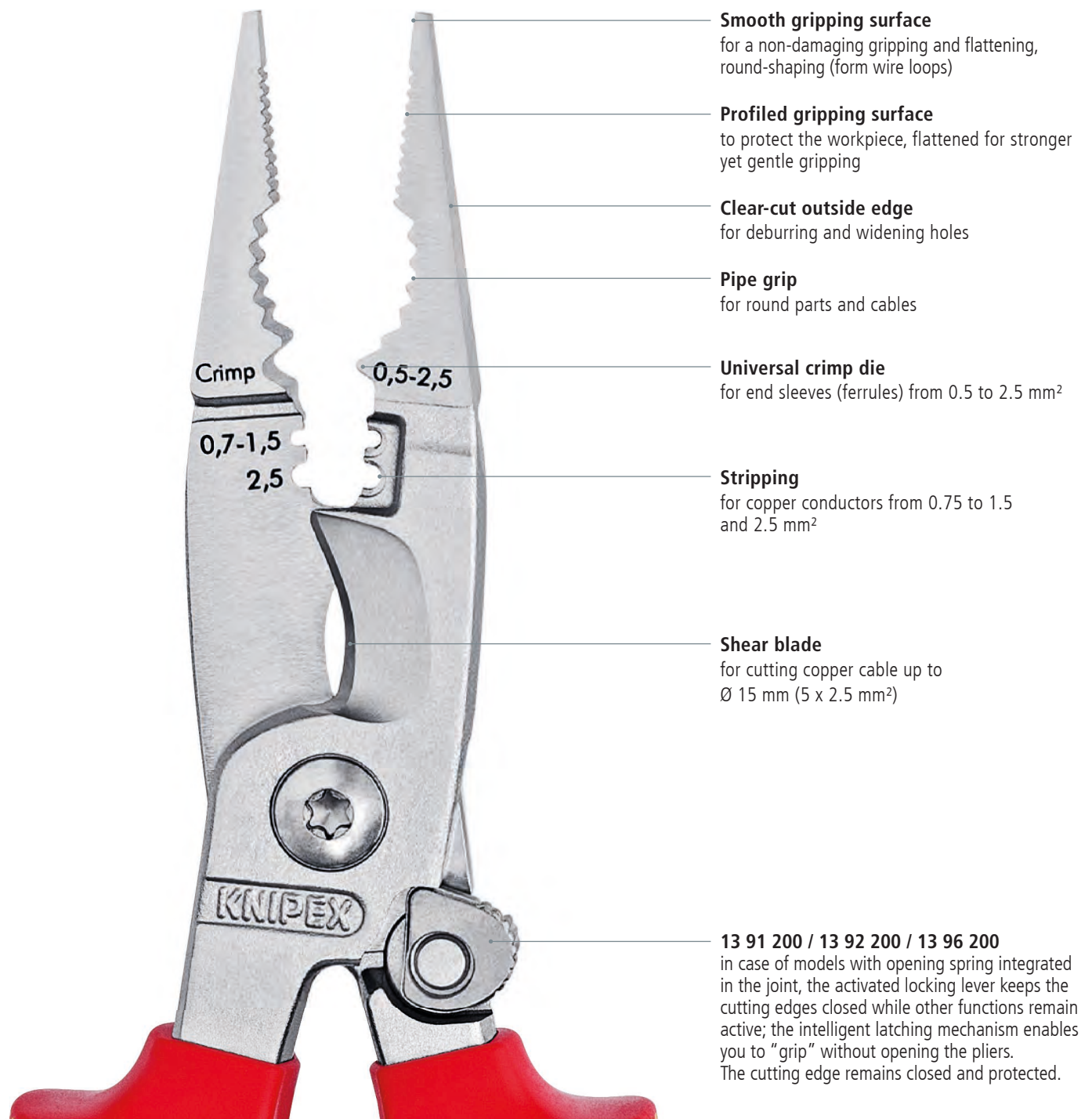

- Smooth gripping surface**
for a non-damaging gripping and flattening, round-shaping (form wire loops)
- Profiled gripping surface**
to protect the workpiece, flattened for stronger yet gentle gripping
- Clear-cut outside edge**
for deburring and widening holes
- Pipe grip**
for round parts and cables
- Universal crimp die**
for end sleeves (ferrules) from 0.5 to 2.5 mm²
- Stripping**
for copper conductors from 0.75 to 1.5 and 2.5 mm²
- Shear blade**
for cutting copper cable up to Ø 15 mm (5 x 2.5 mm²)
- 13 91 200 / 13 92 200 / 13 96 200**
in case of models with opening spring integrated in the joint, the activated locking lever keeps the cutting edges closed while other functions remain active; the intelligent latching mechanism enables you to "grip" without opening the pliers. The cutting edge remains closed and protected.

Article No.	EAN 4003773-	↔ mm	Pliers	Head	Handles	Cutting capacities		Stripping capacity for cross-sections mm ²	Crimping capacities mm ²	⚖ g
						Ø mm	mm ²			
13 81 200	075240	200	black atramentized	polished	plastic coated	15.0	50	0.75 - 1.5 / 2.5	0.5 - 2.5	265
13 82 200	075080	200	black atramentized	polished	with multi-component grips	15.0	50	0.75 - 1.5 / 2.5	0.5 - 2.5	280
13 82 200 T	079972	200	black atramentized	polished	with multi-component grips and integrated tether attachment point	15.0	50	0.75 - 1.5 / 2.5	0.5 - 2.5	267
13 86 200	075097	200	⚠ 1000 V 🔌 chrome plated	chrome plated	insulated with multi-component grips, VDE-tested	15.0	50	0.75 - 1.5 / 2.5	0.5 - 2.5	280
13 91 200	075257	200	black atramentized	polished	plastic coated	15.0	50	0.75 - 1.5 / 2.5	0.5 - 2.5	265
13 92 200	075103	200	black atramentized	polished	with multi-component grips	15.0	50	0.75 - 1.5 / 2.5	0.5 - 2.5	280
13 96 200	075110	200	⚠ 1000 V 🔌 chrome plated	chrome plated	insulated with multi-component grips, VDE-tested	15.0	50	0.75 - 1.5 / 2.5	0.5 - 2.5	280
13 96 200 T	081425	200	⚠ 1000 V 🔌 chrome plated	chrome plated	insulated with multi-component grips, VDE-tested, with integrated insulated tether attachment point for a tool tether	15.0	50	0.75 - 1.5 / 2.5	0.5 - 2.5	275

Electricians' Pliers

- > The ideal pliers for cable work
- > For gripping and bending wire
- > For cutting medium hard and hard wire
- > Precision cutting edges additionally induction-hardened, cutting edge hardness approx. 60 HRC
- > With precision stripping holes
- > For crimping wire ferrules
- > Vanadium electric steel, forged, multi stage oil-hardened

13 05 160 T*

- > Pliers with tether attachment point for mounting a fall protection



13 01 160



13 02 160



13 05 160



13 05 160 T

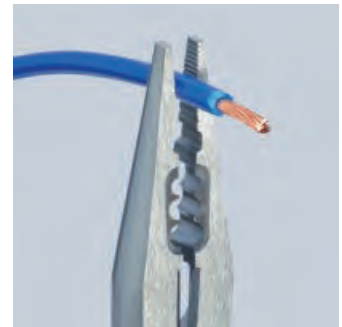
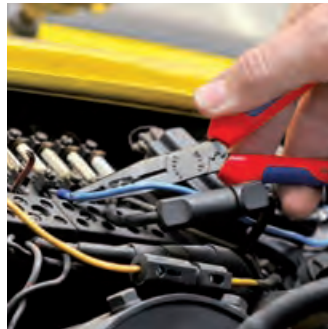

Cutting Edges

Stripping

Crimping 0.5 to 2.5 mm²

Gripping

Article No.	EAN 4003773-	↔ mm		Pliers	Head	Handles	Cutting capacities		Stripping capacities mm ²	g
							Ø mm	Ø mm		
13 01 160	034971	160		black atramentized	polished	plastic coated	2.5	1.6	0,5 - 0,75 / 1,5 / 2,5	112
13 02 160	010470	160		black atramentized	polished	with multi-component grips	2.5	1.6	0,5 - 0,75 / 1,5 / 2,5	139
13 05 160	071426	160		chrome plated	chrome plated	with multi-component grips	2.5	1.6	0,5 - 0,75 / 1,5 / 2,5	139
13 05 160 T	079965	160		chrome plated	chrome plated	with multi-component grips and integrated tether attachment point	2.5	1.6	0,5 - 0,75 / 1,5 / 2,5	142

Round Pliers with cutting edge

Jewellers' Pliers

- > For gripping and manipulating fine wires, e.g. in jewellery work
- > Ideal for cutting and bending activities, also in electronics
- > For bending wire loops
- > Precision-ground round jaws with fine, pointed tips
- > Cutting edges additionally induction-hardened, cutting edge hardness approx. 60 HRC
- > Vanadium electric steel, forged, multi stage oil-hardened



19 01 130

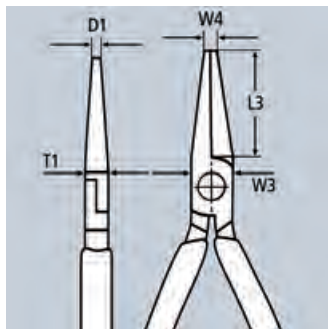

Article No.	EAN 4003773-	↔ mm	▶ ◀ 8	Pliers	Head	Handles	Cutting capacities		Dimensions					Δ g
							● Ø mm	● Ø mm	D1 mm	L3 mm	T1 mm	W3 mm	W4 mm	
19 01 130	034995	130	▶ ◀ 8	black atramentized	polished	plastic coated	2.2	1.6	1.0	32.0	8.0	13.5	2.0	73
19 03 130	014348	130	▶ ◀ 8	chrome plated	chrome plated	plastic coated	2.2	1.6	1.0	32.0	8.0	13.5	2.0	72

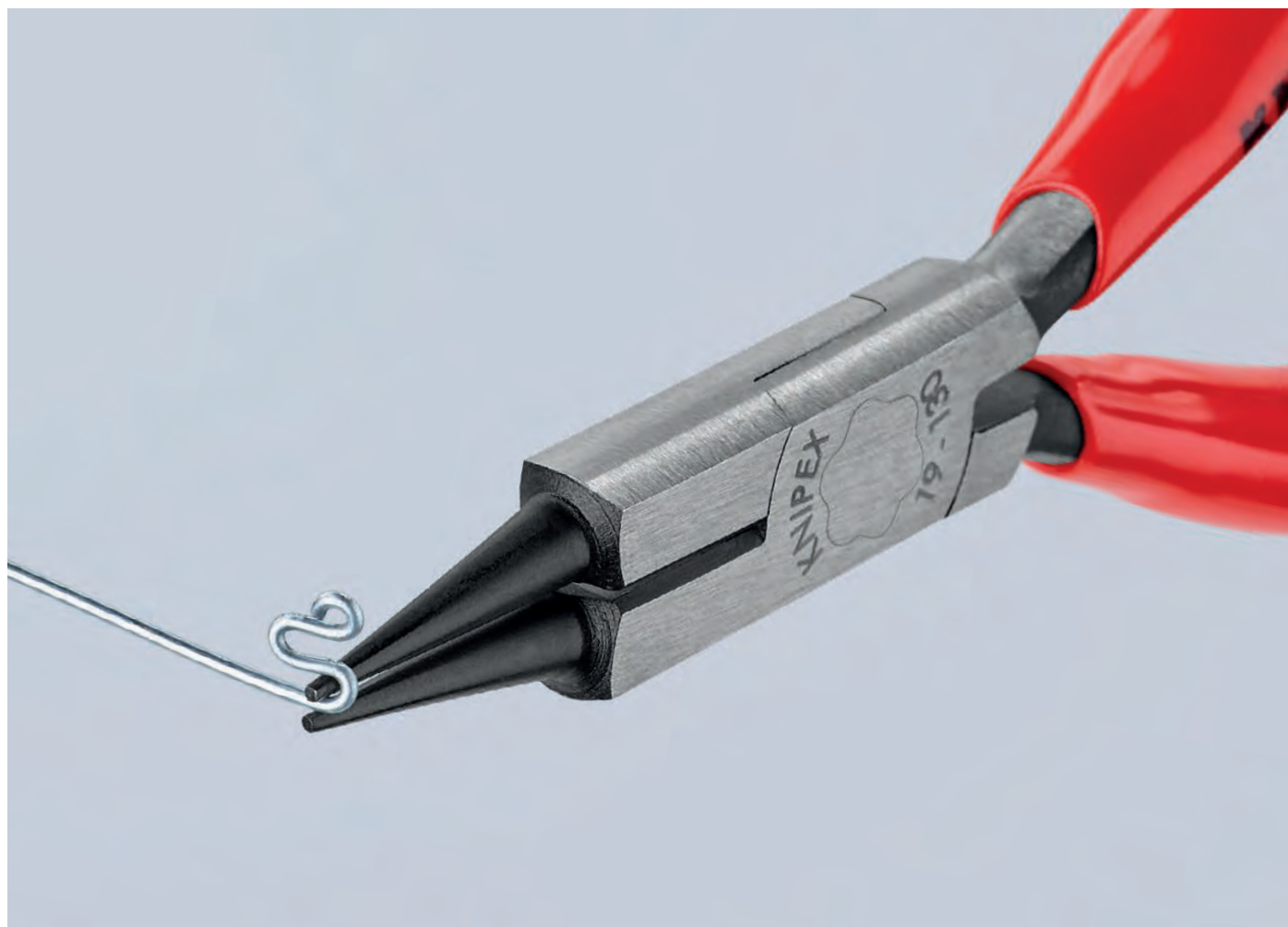

Flat Nose Pliers with cutting edges

Precision Mechanics Pliers

- > Suitable for finer gripping and cutting work
- > Flat, long jaws, tapering
- > Cutting edges additionally induction-hardened, cutting edge hardness approx. 60 HRC
- > High-grade special tool steel, forged, multi stage oil-hardened
- > DIN ISO 5745

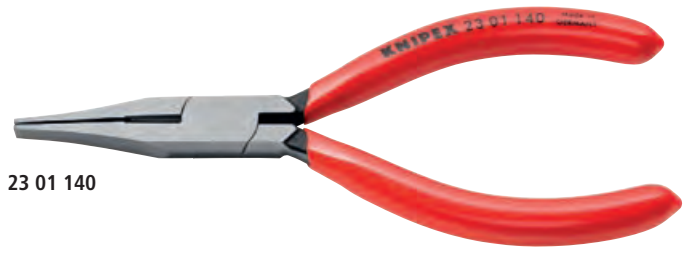

23 01 140

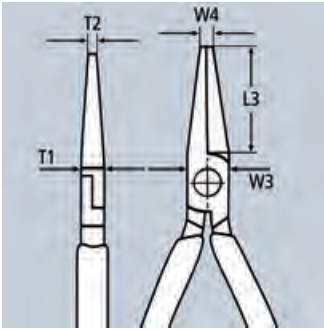

Article No.	EAN 4003773-	↔ mm	Head	Handles	Cutting capacities		Dimensions					⚖ g
					Ø mm	Ø mm	T1 mm	L3 mm	W3 mm	W4 mm	T2 mm	
23 01 140	041290	140	polished	plastic coated	2.5	1.6	7.0	35.0	12.5	3.0	4.5	75

Snipe Nose Pliers with centre cutter

Telephone Pliers

- > For gripping and separating of single wires in harnesses
- > With centre cutter for soft wire
- > Half-round jaws
- > Knurled gripping surfaces
- > Chrome vanadium electric steel, forged, oil-hardened



27 01 160

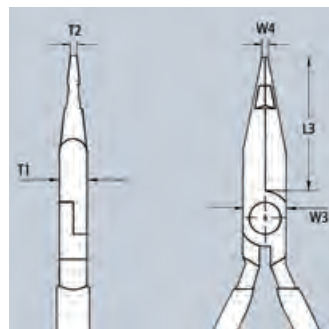

Article No.	EAN 4003773-	↔ mm	Head	Handles	Dimensions					⚖ g
					L3 mm	W3 mm	T1 mm	W4 mm	T2 mm	
27 01 160	016106	160	polished	plastic coated	47.0	16.5	9.5	3.0	2.0	120

Snipe Nose Side Cutting Pliers

Radio Pliers

- > Suitable for finer gripping and cutting work
- > Half-round, long, tapered jaws
- > Knurled gripping surfaces
- > With cutting edges for soft, medium-hard and hard wire
- > Cutting edges additionally induction-hardened, cutting edge hardness approx. 61 HRC
- > Vanadium electric steel, forged, multi stage oil-hardened
- > DIN ISO 5745

25 06 160 T*

- > Pliers with tether attachment point for mounting a fall protection

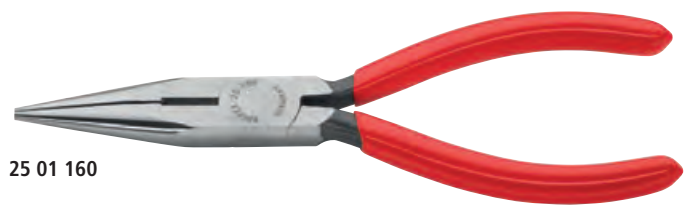

25 01 160

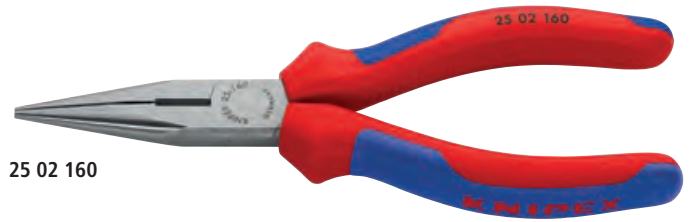

25 02 160



25 25 160



25 25 160

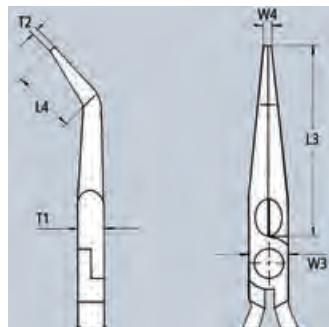
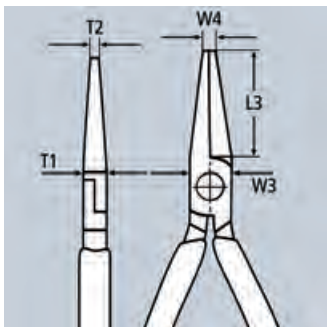

Article No.	EAN	↔ mm		Pliers	Head	Handles	Cutting capacities		Dimensions						
							● mm	● mm	L3 mm	L4 mm	W3 mm	T1 mm	W4 mm	T2 mm	Δ g
25 01 125	015932	125		black atra-mentized	polished	plastic coated	2.2	1.6	27.0		13.0	7.0	2.5	1.8	73
25 01 140	033158	140		black atra-mentized	polished	plastic coated	2.5	1.6	42.0		15.0	8.0	2.5	2.0	90
25 01 160	033912	160		black atra-mentized	polished	plastic coated	2.5	1.6	50.0		16.5	9.0	3.0	2.5	115
25 02 140	023159	140		black atra-mentized	polished	with multi-component grips	2.5	1.6	42.0		15.0	8.0	2.5	2.0	109
25 02 160	023166	160		black atra-mentized	polished	with multi-component grips	2.5	1.6	50.0		16.5	9.0	3.0	2.5	144
25 03 125	043065	125		chrome plated	chrome plated	plastic coated	2.2	1.6	27.0		13.0	7.0	2.5	1.8	72
25 05 140	035015	140		chrome plated	chrome plated	with multi-component grips	2.5	1.6	42.0		15.0	8.0	2.5	2.0	111
25 05 160	022817	160		chrome plated	chrome plated	with multi-component grips	2.5	1.6	50.0		16.5	9.0	3.0	2.5	144
25 06 160	033806	160	 	chrome plated	chrome plated	insulated with multi-component grips, VDE-tested	2.5	1.6	50.0		16.5	9.0	3.0	2.5	146
25 06 160 T	081432	160	 	chrome plated	chrome plated	insulated with multi-component grips, VDE-tested, with integrated insulated tether attachment point for a tool tether	2.5	1.6	50.0		16.5	9.0	3.0	2.5	155
25 21 160	050476	160	 	black atra-mentized	polished	plastic coated	2.5	1.6	50.0	23.0	16.5	9.0	3.0	2.5	116
25 25 160	016007	160	 	chrome plated	chrome plated	with multi-component grips	2.5	1.6	50.0	23.0	16.5	9.0	3.0	2.5	143
25 26 160	052111	160	 	chrome plated	chrome plated	insulated with multi-component grips, VDE-tested	2.5	1.6	50.0	23.0	16.5	9.0	3.0	2.5	144

*Other tools with tethering can be found from page 266

Snipe Nose Side Cutting Pliers

Stork Beak Pliers

► Elastic tips: dimensionally stable even when twisted

- > Distortion-tolerant, elastic precision tips
- > Half-round, long, tapered jaws
- > With cutting edges (hardness approx. 61 HRC) for soft, medium-hard and hard wire
- > Cutting edges additionally induction-hardened, cutting edge hardness approx. 61 HRC
- > Vanadium electric steel, forged, multi stage oil-hardened
- > DIN ISO 5745

26 12 200 T / 26 15 200 T / 26 16 200 T / 26 22 200 T / 26 25 200 T / 26 26 200 T*

> Pliers with tether attachment point for mounting a fall protection

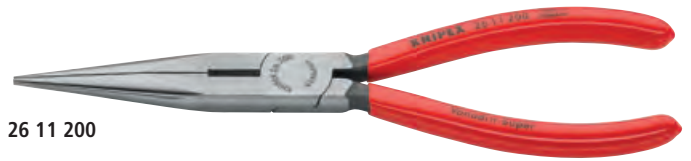
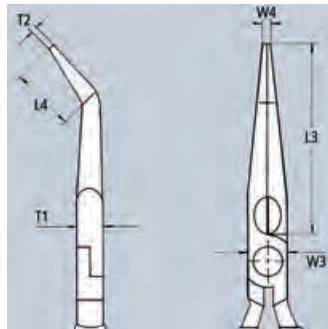
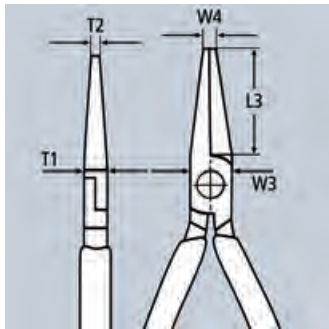

26 11 200

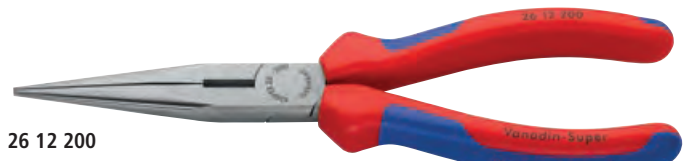

26 12 200



26 12 200 T



26 13 200

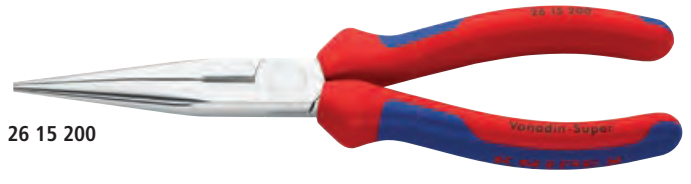

26 15 200

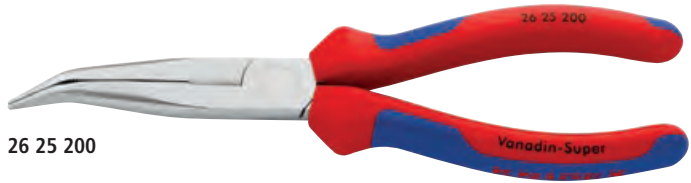

26 25 200

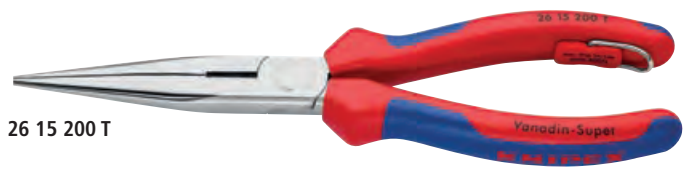

26 15 200 T



26 16 200



26 16 200 T



Article No.	EAN 4003773-	↔ mm				Pliers	Head	Handles	Cutting capacities		Dimensions						
									Ø mm	Ø mm	L3 mm	L4 mm	W3 mm	T1 mm	W4 mm	T2 mm	Δ g
26 11 200	022824	200				black atra- mentized	polished	plastic coated	3.2	2.2	73.0		18.0	9.5	3.0	2.5	170
26 12 200	023142	200				black atra- mentized	polished	with multi-component grips	3.2	2.2	73.0		18.0	9.5	3.0	2.5	201
26 12 200 T	079989	200				black atra- mentized	polished	with multi-component grips and integrated tether attach- ment point	3.2	2.2	73.0		18.0	9.5	3.0	2.5	200
26 13 200	040590	200				chrome plated		plastic coated	3.2	2.2	73.0		18.0	9.5	3.0	2.5	169
26 15 200	035022	200				chrome plated	chrome plated	with multi-component grips	3.2	2.2	73.0		18.0	9.5	3.0	2.5	198
26 15 200 T	079996	200				chrome plated	chrome plated	with multi-component grips and integrated tether attach- ment point	3.2	2.2	73.0		18.0	9.5	3.0	2.5	204
26 16 200	022831	200				chrome plated	chrome plated	insulated with multi-component grips, VDE-tested	3.2	2.2	73.0		18.0	9.5	3.0	2.5	206
26 16 200 T	081449	200				chrome plated	chrome plated	insulated with multi-component grips, VDE-tested, with integrat- ed insulated tether attachment point for a tool tether	3.2	2.2	73.0		18.0	9.5	3.0	2.5	215
26 17 200	016069	200				chrome plated	chrome plated	with dipped insulation, VDE-tested	3.2	2.2	73.0		18.0	9.5	3.0	2.5	212
26 21 200	022848	200				black atra- mentized	polished	plastic coated	3.2	2.2	73.0	23.0	18.0	9.5	3.0	2.5	171
26 22 200	023135	200				black atra- mentized	polished	with multi-component grips	3.2	2.2	73.0	23.0	18.0	9.5	3.0	2.5	197
26 22 200 T	080008	200				black atra- mentized	polished	with multi-component grips and integrated tether attach- ment point	3.2	2.2	73.0	23.0	18.0	9.5	3.0	2.5	202
26 25 200	035039	200				chrome plated	chrome plated	with multi-component grips	3.2	2.2	73.0	23.0	18.0	9.5	3.0	2.5	199
26 25 200 T	080015	200				chrome plated	chrome plated	with multi-component grips and integrated tether attach- ment point	3.2	2.2	73.0	23.0	18.0	9.5	3.0	2.5	205
26 26 200	022855	200				chrome plated	chrome plated	insulated with multi-component grips, VDE-tested	3.2	2.2	73.0	23.0	18.0	9.5	3.0	2.5	204
26 26 200 T	081456	200				chrome plated	chrome plated	with multi-component grips and integrated tether attach- ment point	3.2	2.2	73.0	23.0	18.0	9.5	3.0	2.5	215
26 27 200	016090	200				chrome plated	chrome plated	with dipped insulation, VDE-tested	3.2	2.2	73.0	23.0	18.0	9.5	3.0	2.5	220



Wire Strippers and
Dismantling Tools

Insulation Strippers	20
Electronics Wire Stripping Shears	21
Electronics Wire Stripper	21
Diagonal Insulation Strippers	22
Precision Insulation Strippers with adapted blades	24
Insulation Strippers with adapted blades	25
KNIPEX MultiStrip 10 – Automatic Insulation Stripper	26
Self-Adjusting Insulation Strippers	27
KNIPEX PreciStrip 16 – Automatic Insulation Stripper	28
Automatic Insulation Stripper	30
Automatic Insulation Stripper for flat cable	31
Automatic Stripping Pliers	31
Mini Wire Stripper	32
Wire Stripper for fibre optics	32
Stripping Tool for fibre optics	33
Stripping Tweezers for coated wire	33
Stripping Pliers	34
KNIPEX StriX® – Insulation strippers with cable shears	35
Insulation Strippers	36
Stripping Tools with scalpel blade	36
Folding Knife for Electricians	37
Stripping Tools for spiral cutting	37
Stripping Tool for coax cables	38
Wire Stripping Tool for coax and data cable	39
Stripping Tool for flat and round cables	40
Stripping Tool for data cables	40
Universal Stripping Tools	41
Depth Stripping Tool	41
KNIPEX ErgoStrip® – Universal Stripping Tool	43



Insulation Strippers

universal

- > For single, multiple and fine stranded conductors with plastic or rubber insulation up to 5.0 mm dia. or 10 mm² cable cross-section
- > Easy adjustment to the required diameter of solid or stranded wire with knurled screw and lock nut
- > Special tool steel, forged, oil-hardened

11 06 160 T

- > Pliers with tether attachment point for mounting a fall protection

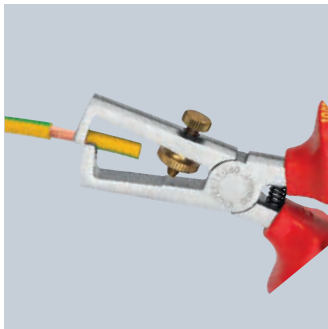
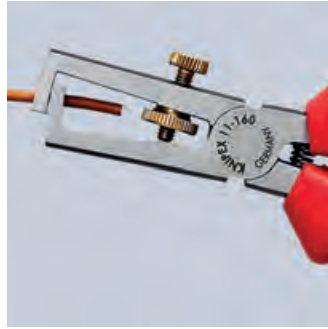

11 01 160



11 02 160



11 05 160



11 06 160 T



11 12 160

Article No.	EAN 4003773-	↔ mm	Pliers	Head	Handles	Stripping capacities			Δ g
						Ø mm	mm ²	AWG	
11 01 160	033868	160	black atramentized	polished	plastic coated	5.0	10	7	131
11 02 160	023180	160	black atramentized	polished	with multi-component grips	5.0	10	7	165
11 05 160	039570	160	chrome plated	chrome plated	with multi-component grips	5.0	10	7	157
11 06 160	021933	160	chrome plated	chrome plated	insulated with multi-component grips, VDE-tested	5.0	10	7	200
11 06 160 T	081418	160	chrome plated	chrome plated	insulated with multi-component grips with integrated insulated tether attachment point, VDE tested	5.0	10	7	180
11 07 160	015499	160	chrome plated	chrome plated	with dipped insulation, VDE-tested	5.0	10	7	180
11 12 160	034964	160	black atramentized	polished	with multi-component grips	5.0	10	7	156
11 09 01	052326	Set of spare parts (screw and nut) for 11 160							

Electronics Wire Stripping Shears

- > For cutting and stripping solid, multicore and finely stranded conductors with conductor cross-section up to 0.75 mm²
- > Pointed head of shears above the wire stripping hole for the accurate cutting of fine wire in confined places
- > Easy adjustment to the required diameter of solid or stranded wire with knurled screw and lock nut
- > With opening spring
- > Special tool steel, oil-hardened



11 82 130



Article No.	EAN	↔ mm		Head	Handles	Stripping capacities mm ²	⚖ g
11 82 130	4003773-071648	140	MM	polished	with multi-component grips	0.01 - 0.75	85

Electronics Wire Stripper

- > For single, multiple and fine stranded cables having a diameter from 0.1 up to 0.8 mm, with plastic or rubber insulation
- > Easy adjustment to the required diameter of solid or stranded wire with knurled screw and lock nut
- > With opening spring
- > The mirror polish together with a fine film of oil offer effective rust protection - no circuit faults caused by peeling chrome from plated tools
- > Special tool steel, forged, oil-hardened



11 92 140

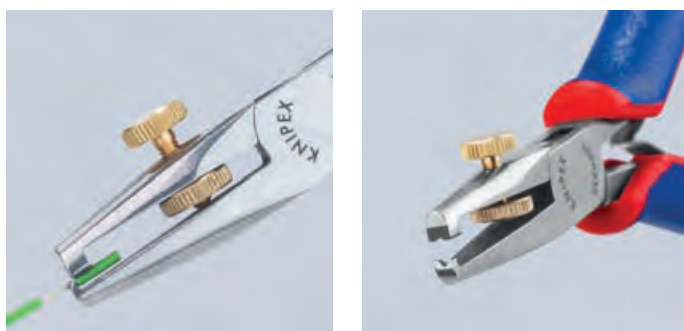

Article No.	EAN	↔ mm		Head	Handles	Stripping capacities Ø mm	⚖ g
11 92 140	4003773-016908	140	MM	mirror polished	with multi-component grips	0.1 - 0.8	99



Diagonal Insulation Strippers

- ▶ With long cutter
- ▶ High cutting capacity due to high leverage joint
- > Precision stripping holes for single conductors of 1.5 and 2.5 mm²
- > Convenient cutting of NYM cables up to 5 x 2.5 mm²
- > Long tips for ultra fine cutting work also in confined areas
- > Induction-hardened precision blades, cutting edge hardness approx. 60 HRC
- > Vanadium electric steel, forged, multi stage oil-hardened

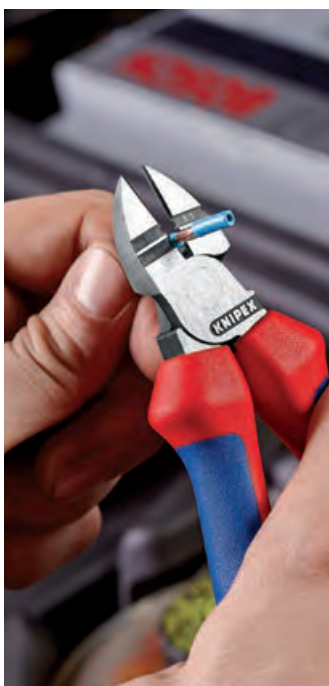

14 22 160



14 25 160



14 26 160



elongated cutting edge

improved transmission ratio

Article No.	EAN 4003773-	↔ mm		Pliers	Head	Handles	Stripping capacities mm ²	AWG	Cutting capacities		
									⊙ Ø mm	⊙ Ø mm	⚖ g
14 22 160	034988	160		black atramentized	polished	with multi-component grips	1.5 / 2.5	15 / 13	2.5	1.5	206
14 25 160	028697	160		chrome plated	chrome plated	with multi-component grips	1.5 / 2.5	15 / 13	2.5	1.5	224
14 26 160	040279	160		chrome plated	chrome plated	insulated with multi-component grips, VDE-tested	1.5 / 2.5	15 / 13	2.5	1.5	216

Precision Insulation Strippers

with adapted blades

- > Form-fit stripping also of difficult-to-remove insulating materials made of PTFE, silicone, Radox®, Kapton® and rubber; multi-layer too
- > A second pair of blades holds the remaining insulation reliably in place
- > Replaceable shaped blade adapted precisely to the respective conductor cross-section
- > With length stop for constant stripping length during repetitive work
- > Blade: special tool steel, oil-hardened
- > Pliers body: steel



12 12 02



12 12 11



12 12 13



Precise cutting of the insulation to a complete extent



Positive stripping thanks to precise shape of the blades



12 12 02 with cable guide and length stop

12 12 02

- > With additional cable guide for exact positioning of the cable in the stripping area of the blade

12 12 11 / 12 12 12 for solar cable

- > Specially adapted to multilayer and Radox® insulation
- > With additional cable support for a better centring of multi-layer insulated conductors in the stripping profiles

12 12 13 / 12 12 14

- > Especially for cables in accordance with the American specification (AWG)

Maximum cable cross-section (in mm²) per profile:

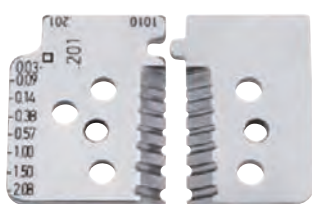

12 19 02

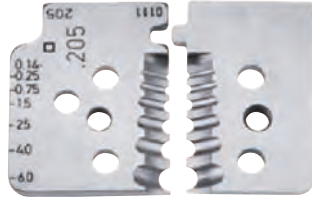

12 19 06



12 19 10

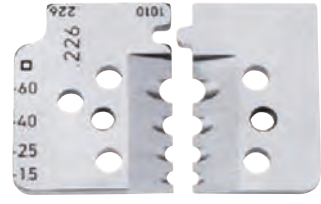

12 19 11

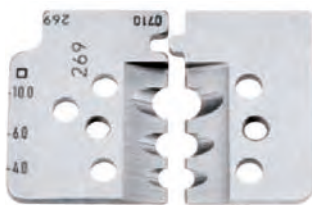

12 19 12

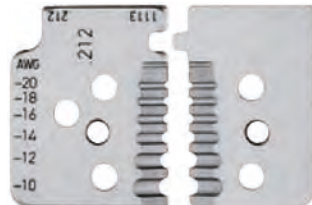

12 19 13

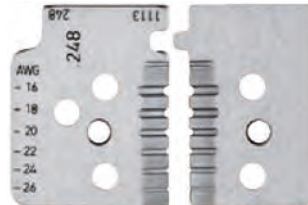

12 19 14

Radox® is a registered trademark of Huber & Suhner AG
Kapton® is a registered trademark of E. I. du Pont de Nemours and Company

Principle of operation with adapted blades

Properly and precise stripping with an annular cut through the complete insulation. This is particularly important with conductors, which must be stripped precisely.

This works without any problem even with difficult insulating materials made of PTFE, Radox® and multilayer insulations.

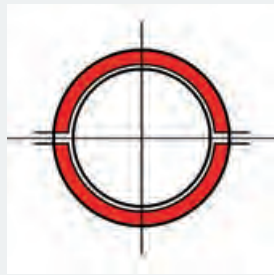

Precisely and reliably

Two pairs of blades (1) cut the insulation to a complete extent. Then the blade pairs move apart, and thus the insulation is removed form-fit (2). The pliers open automatically after the stripping procedure.

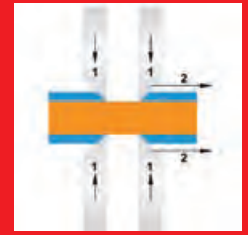

Article No.	EAN 4003773-	↔ mm	Pliers	Handles	Stripping capacities		AWG	⚖ g	
					mm ²				
12 12 02	048077	195	MM (PATENTED)	burnished	with multi-component grips	0.03 - 0.09 / 0.14 / 0.38 / 0.57 / 1 / 1.5 / 2.08		32 - 14	447
12 12 06	049005	195				0.14 - 0.25 / 0.75 / 1.5 / 2.5 / 4 / 6		26 - 10	445
12 12 10	049012	195				2.5 / 4 / 6 / 10		13 - 7	445
12 12 11	062998	195	MM (PATENTED)	burnished	with multi-component grips	1.5 / 2.5 / 4 / 6		15 - 10	449
12 12 12	073758	195				4 / 6 / 10		11 - 7	450
12 12 13	077534	195	MM (PATENTED)	burnished	with multi-component grips			10 / 12 / 14 / 16 / 18 / 20	450
12 12 14	077541	195						16 / 18 / 20 / 22 / 24 / 26	450
12 19 02	049036	1 set of spare blades for 12 12 02							
12 19 06	049043	1 set of spare blades for 12 12 06							
12 19 10	049050	1 set of spare blades for 12 12 10							
12 19 11	063001	1 set of spare blades for 12 12 11							
12 19 12	073765	1 set of spare blades for 12 12 12							
12 19 13	077558	1 set of spare blades for 12 12 13							
12 19 14	077565	1 set of spare blades for 12 12 14							

Insulation Strippers

with adapted blades

- > With replaceable blades for 4 (adapted to diameters) or 6 (adapted to cross-sections) different conductor cross-sections
- > Leave wire undamaged thanks to precision-ground blade shapes, even multi-stranded conductors are stripped gently
- > During stripping, the wire is held firmly by clamping jaws
- > With length stop for constant stripping length during repetitive work
- > A spring leads the stripper back to the starting position
- > Blade: special tool steel, oil-hardened
- > Pliers body: aluminium

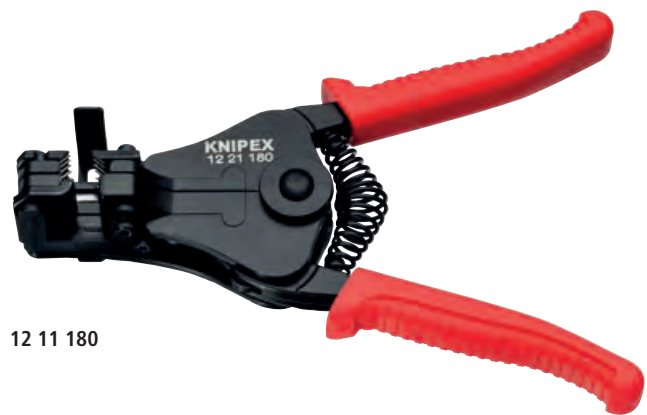

12 11 180

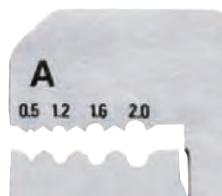

12 11 180: wire diameter in mm



12 21 180: wire cross-sections in mm²

Article No.	EAN 4003773-	↔ mm	Pliers	Handles	Stripping capacities		AWG	⚖ g	
					Ø mm	mm ²			
12 11 180	000792	180	MM	black lacquered	with plastic grips	0.5 / 1.2 / 1.6 / 2.0		368	
12 21 180	000815	180				0.5 - 0.75 / 1 / 1.5 / 2.5 / 4 / 6		20 - 19 / 17 / 15 / 13 / 11 / 10	335
12 19 180	022145	1 pair of spare blades for 12 11 180							
12 29 180	022152	1 pair of spare blades for 12 21 180							

KNIPEX MultiStrip 10

Automatic Insulation Stripper

- ▶ Stripping without re-adjustment from 0.03 to 10.0 mm²
 - ▶ Recessed wire cutter
 - ▶ Universal blade geometry -robust and more durable
 - ▶ Ideal grip design with excellent haptics
-
- > Fully automatic adjustment to all single-, multi- and fine-stranded conductors with standard insulation throughout the entire capacity range from 0.03 to 10.0 mm²
 - > No manual fine adjustment necessary
 - > No damage to the conductors
 - > The clamping jaws made of steel hold the cable in a way that prevents slipping without damaging the remaining insulation
 - > With recessed wire cutter for Cu and Al conductors, stranded up to 10 mm² and single wire up to 6 mm²
 - > Particularly smooth-running mechanics and very low weight
 - > Replaceable blades block and length stop
 - > Handle with soft-plastic zone for a steady grip
 - > Body: plastic, fibreglass-reinforced
 - > Blade: special tool steel, oil-hardened



12 42 195

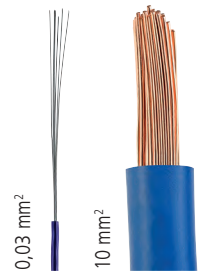

Steel clamping jaws avoid slipping of the cable



Precise stripping from 0.03 to 10 mm² without re-adjustment

Patented mechanics

The incision depth of the stripping blade adjusts fully automatically to the diameter of the wire and accordingly also to the thickness of all standard insulating materials.

There is no need for any manual adjustment which is still necessary when other conventional pliers with a wide wire-stripping range are used.



Wire cutter for multiple stranded wire cables up to 10.0 mm²



Mode of operation of straight cutters

An incision is made in the red area only.

Not suitable for highly-flexible or armoured insulation materials or for multi-layered insulation.

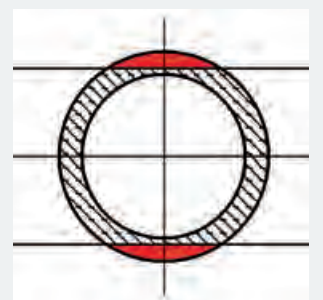

Article No.	EAN 4003773-	↔ mm		Stripping capacities mm ²	AWG	⚖ g
12 42 195	054580	195	MM (PATENTED)	0.03 - 10	32 - 7	136
12 49 04	053071	Torsion spring for 12 40/50 200				
12 49 21	057581	Spare blades block for 12 42 195				
12 49 23	057604	Spare length stop for 12 42 / 52 195				

Self-Adjusting Insulation Strippers

- > For single, multiple and fine stranded conductors with plastic or rubber insulation
- > Adapts automatically to the respective cable cross-section; prevents damage to the conductor
- > Cutting depth can be adjusted for different insulation materials
- > With wire cutter for copper and aluminium wires, multiple stranded up to 10 mm² and single stranded up to 6 mm²
- > Smoothly operating mechanism
- > Stripping blades and clamping jaws easily replaceable
- > Low weight
- > Body: plastic, fibreglass-reinforced
- > Blade: special tool steel, oil-hardened

12 40 200

- > For thin ribbon cables up to 10.0 mm width in a single pass



12 40 200



12 50 200



12 40 200: Adjustable length stop



12 40 200: Precise stripping prevents damage to the conductor



Article No.	EAN	↔ mm		Stripping capacities mm ²	AWG	Length stop mm	⚖ g	
12 40 200	026662	200	MM	0.03 - 10	32 - 7	3.0 - 18.0	202	
12 50 200	034407	200	MM	2.5 - 16	13 - 5		200	
12 49 01	026679	1 pair of spare blades for 12 40 200						
12 49 02	026686	1 pair of spare clamping jaws for 12 40 200						
12 49 03	026693	Spare length stop for 12 40 200						
12 49 04	053071	Torsion spring for 12 40/50 200						
12 49 05	053088	Coil spring in the head for 12 40/50 200						
12 59 01	034414	1 pair of spare blades for 12 50 200						
12 59 02	034421	1 pair of spare clamping jaws for 12 50 200						

Capacity of
0.08–16 mm²

KNIPEX PreciStrip16

Automatically strips insulation – and thanks to additional zero correction, it also grips where automatic devices would otherwise fail

KNIPEX PreciStrip16

Properly stripped away: with deft precision, strip everything from very fine to thick cables with stranded or solid conductors

- ▶ Simple, precise stripping of fine wires and solid round cables with a wide capacity range from 0.08 to 16 mm² with only one pair of pliers
 - ▶ Good grip provided by semi-circular grooved metal holding clamps and exact cut from parabolic stripping blade
 - ▶ A patented automatism regulates the depth of the cut; the neutral point of the automatism can be adjusted in fine steps in special operating conditions (insulation material, temperature)
- > With cable cutter for stranded wire from 0.08 to 16 mm²
 - > With tether attachment point, suitable for KNIPEX Tethered Tools accessories
 - > Inscription area for customisation
 - > With adjustable length stop for precision work repeated accurately each time
 - > Comfortable operation with ergonomic dual-component handle
 - > Easily replaceable blade cassette



12 52 195

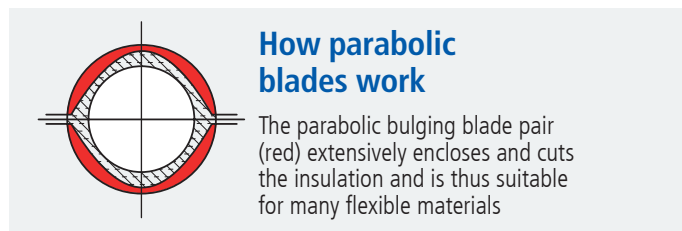

Semi-circular grooved holding clamp for better grip that holds practically any insulation material securely in place



For special requirements, such as particularly hard or soft insulation materials, optimum fine adjustments can be made using the adjusting wheel with its tactile locking positions



With cable cutter on the top side for up to 16 mm²

Article No.	EAN	↔ mm	⊗ mm ²	⊗ AWG	⚖ g
12 52 195	4003773-085829	195	0.08 - 16	28 - 5	180
12 52 195 SB	085997	195	0.08 - 16	28 - 5	180
12 49 31	086000	Spare blade pair for 12 52 195			10

Automatic Insulation Stripper

Work faster: Adjusts automatically to most cable types, with fine adjustment for special materials

- ▶ Strips cables with standard materials without any need for manual adjustment
- ▶ Fine adjustment enables accurate setting of the blades to special materials or temperature requirements
- ▶ Compact, handy and lightweight tool for common cable cross-sections and insulating materials
- > For single, multiple and fine stranded cables of 0.2 up to 6 mm² with standard insulation
- > Narrow head style for use in confined areas
- > With wire cutter for copper and aluminium wires up to 2.5 mm²
- > With adjustable length stop from 6.0 - 18.0 mm for cutting the same stripping lengths during repetitive work
- > Body: plastic, fibreglass-reinforced
- > Blades: special tool steel, oil-hardened, interchangeable



12 62 180

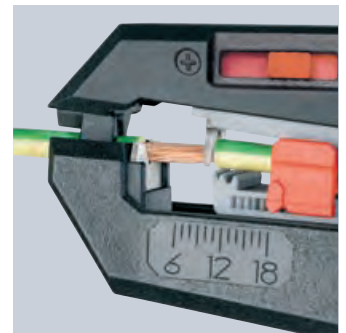

Article No.	EAN	↔ mm		Stripping capacities mm ²	AWG	Δ g
12 62 180	4003773-054573	180	MM	0.2 - 6	24 - 10	151
12 69 21	060093	1 pair of spare blades for 12 62 180				
12 69 23	067115	Spare length stop for 12 62 180				

Automatic Insulation Stripper for flat cable

- > For PVC insulated flat cables up to a max. 12 mm width and 0.75 to 2.5 mm²
- > Adapts automatically to various conductor heights; prevents damage to the conductor
- > Long stripping lengths possible
- > Blade replaceable
- > Smoothly operating mechanism
- > Low weight
- > Body: plastic, fibreglass-reinforced
- > Blade: special tool steel, oil-hardened



12 64 180

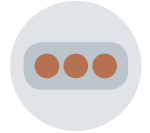

Sectional view of an ribbon cable

Article No.	EAN 4003773-	↔ mm		Stripping capacities mm ²	AWG	⚖ g	
12 64 180	073284	180	MM	0.75 - 2.5	19 - 13	125	
12 69 31	073932	1 pair of spare blades for 12 64 180					

Automatic Stripping Pliers

- ▶ For control and sensor cables / actuator cables, also for stripping flexible feed cables and extension cable
 - ▶ Automatic adjustment to cable diameters between 4.4 mm and 7.5 mm
 - ▶ No damage to the inner conductor or shield braid
- > For oil-resistant, halogen-free control and sensor / actuator cables with multicore cable design
 - > Shielded and unshielded
 - > Suitable for highly flexible TPE-U-pipes, PUR and PVC cable sheathing, rubber leads such as H05 etc.
 - > Long stripping lengths possible
 - > Body: plastic, fibreglass-reinforced
 - > Blades: special tool steel, oil-hardened, interchangeable



12 74 180 SB



Sectional view of an extension cord



Complex cutter design for precise and damage-free stripping of round cables



Required stripping length easy to read off

Article No.	EAN 4003773-	↔ mm		Stripping capacities Ø mm	⚖ g	
12 74 180 SB	082323	175	MM	4.4 - 7.5	145	
12 79 31	082682	1 pair of spare blades for 12 74 180 SB				

Mini Wire Stripper

- > Precise stripping, stepwise adjustment to the conductor diameters
- > With wire cutter
- > Adjustable length stop from 4.0 - 15.0 mm
- > With locking device
- > Housing: plastic, impact-proof

12 80 040 SB

- > For thin copper conductors dia. 0.12 to 0.4 mm

12 80 100 SB

- > For thin copper conductors dia. 0.3 to 1.0 mm



12 80 100 SB

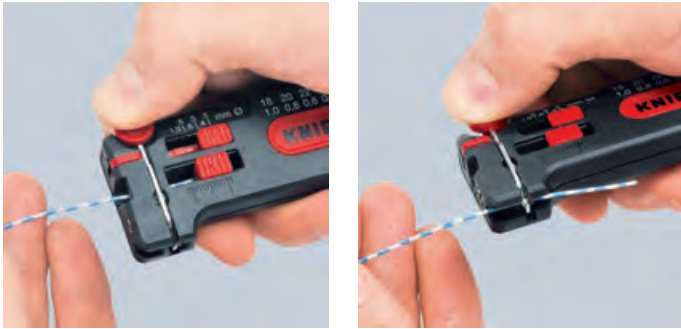

Article No.	EAN 4003773-	↔ mm	MM	Stripping capacities Ø mm	AWG	Δ g
12 80 040 SB	071655	100		0.12 - 0.4	36 - 26	35
12 80 100 SB	043119	100		0.3 - 1.0	28 - 18	34

Wire Stripper for fibre optics

- > To remove primary and secondary coating of fibre optics
- > Chrome vanadium electric steel in special quality, oil-hardened



12 82 130 SB



Article No.	EAN 4003773-	↔ mm	Pliers	Handles	Stripping capacities Ø mm	Δ g
12 82 130 SB	050094	130	burnished	with plastic grips	primary-coating: 0.125 mm; secondary-coating: 0.250 mm	75

Stripping Tool for fibre optics

- > To remove primary coating of fibre optics \varnothing 0.125 mm
- > Blade dia. 0.18 mm, hole for cable feeding 0.30 mm dia.
- > Adjustable length stop
- > Housing: plastic, impact-proof



12 85 100 SB



Article No.	EAN 4003773-	↔ mm	Stripping capacities \varnothing mm	Δ g
12 85 100 SB	043126	100	primary-coating 0.125 mm	25

Stripping Tweezers for coated wire

- > For stripping off varnished insulation on copper wires
- > Blades for other wire diameters available as spare parts
- > Tweezers body: spring steel, oil-hardened
- > Handle shells: plastic



15 11 120



Article No.	EAN 4003773-	↔ mm	Stripping capacities \varnothing mm	Δ g
15 11 120	015550	120	0.6	34

15 19 005	021551	1 pair of spare blades for 15 11 120 \varnothing 0.5 mm		
15 19 006	021568	1 pair of spare blades for 15 11 120 \varnothing 0,6 mm		
15 19 008	021575	1 pair of spare blades for 15 11 120 \varnothing 0,8 mm		
15 19 010	021582	1 pair of spare blades for 15 11 120 \varnothing 1,0 mm		

Stripping Pliers

Multifunctional – cutting and stripping with one pair of pliers

- ▶ For time-saving stripping of all round sheathed and damp-proof installation cables (e.g. NYM cable)
 - ▶ Simplified access especially into deep mounted junction boxes thanks to slim head design and optimally angled cable sheath cutter
 - ▶ Strip cables easily and without damage thanks to circular cutting edge with depth limiter
-
- > Suitable for universal use: precision wire stripping holes for conductors from 1.5 and 2.5 mm²
 - > With side cutters for cutting and trimming conductors, wires, small screws and nails
 - > All cutters additionally induction-hardened to approx. 61 HRC for high wear resistance
 - > 30 % lighter than comparable pliers
 - > Vanadium electric steel, forged, multi stage oil-hardened

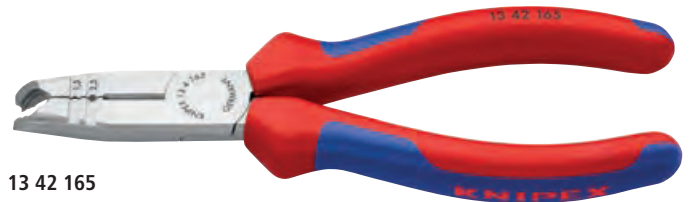

13 42 165

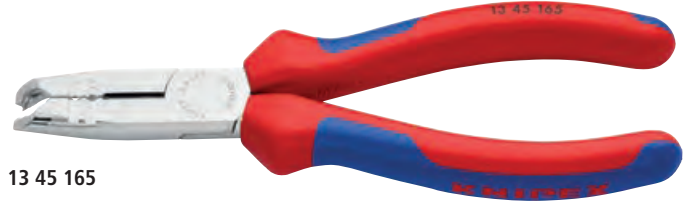

13 45 165



13 46 165



Cutting cable up to Ø 13 mm



Cutting when shortening single conductors

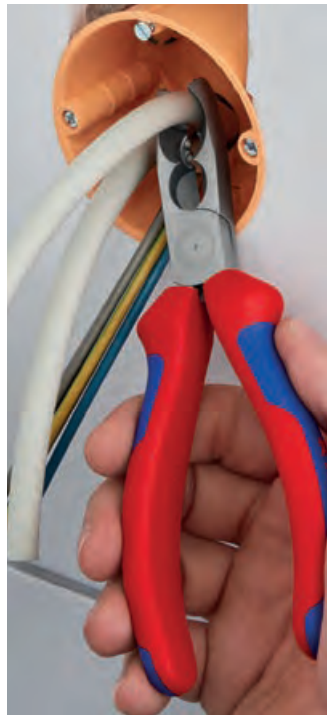

Stripping deep down in a flush-mounted junction box



Wire stripping holes for 1.5 and 2.5 mm² conductors

Article No.	EAN 4003773-	↔ mm		Pliers	Head	Handles	Dismantling capacities Ø mm	Stripping capacities mm ²	⊙ Ø mm	⊙ Ø mm	⚖ g
13 42 165	079675	165		black atramentized	polished	with multi-component grips	8.0 - 13.0	0.75 - 1.5 / 2.5	3.2	2.2	176
13 45 165	079682	165		chrome plated	chrome plated	with multi-component grips	8.0 - 13.0	0.75 - 1.5 / 2.5	3.2	2.2	176
13 46 165	079699	165	 	chrome plated	chrome plated	insulated with multi-component grips, VDE-tested	8.0 - 13.0	0.75 - 1.5 / 2.5	3.2	2.2	190

KNIPEX StriX®

Insulation strippers with cable shears Two functions in one pair of pliers

- > For single, multiple and fine stranded conductors with plastic or rubber insulation up to 5.0 mm dia. or 10 mm² cable cross-section
- > Increments in the jaw provide a visual orientation aid for stripping consistent lengths (11 mm and 16 mm)
- > Easy adjustment to the required diameter of solid or stranded wire with knurled screw and lock nut
- > Shear blade for cutting copper and aluminium cable up to Ø 15 mm (5 x 2.5 mm²)
- > Cutting edges additionally induction-hardened, cutting edge hardness approx. 57 HRC
- > Slim dimensions for easy access
- > Bolted joint: precise, zero backlash operation of pliers
- > High-grade special tool steel, forged, multi stage oil-hardened

13 66 180 T*

- > Pliers with tether attachment point for mounting a fall protection



13 62 180



13 66 180



13 66 180 T



Induction-hardened precision cutter



Length mark: Profiling on the inner side helps when stripping wire in standard lengths (11 mm and 16 mm)



Induction-hardened shear blade with precisely ground cutting edges for crush-free cutting of copper and aluminium cables of up to Ø 15 mm (5 x 2.5 mm²)

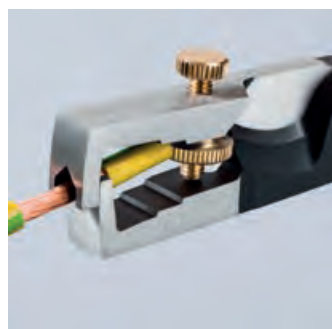

Lock nut prevents any unintentional adjustment



Article No.	EAN 4003773-	↔ mm	Pliers	Handles	Stripping capacities			Δ g
					Ø mm	mm ²	AWG	
13 62 180	081302	180	black atramentized	with multi-component grips	5.0	10	8	200
13 66 180	081319	180	chrome plated	insulated with multi-component grips, VDE-tested	5.0	10	8	215
13 66 180 T	081906	180	chrome plated	insulated with multi-component grips with integrated insulated tether attachment point, VDE tested	5.0	10	8	215

*Other tools with tethering can be found from page 266

Insulation Strippers

- > For stripping thin cables
- > Accurate boring to match diameter of wire, precise stripping prism; non-adjustable
- > With opening spring
- > Chrome vanadium electric steel, forged, oil-hardened



15 61 160

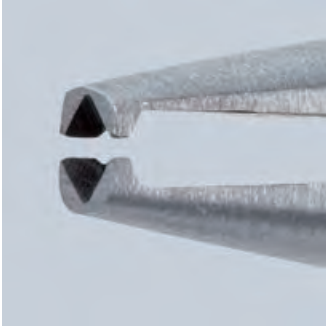

Article No.	EAN 4003773-	↔ mm		Head	Handles	Stripping capacities	
						Ø mm	△ g
15 51 160	044451	160	MM	polished	plastic coated	0.5	101
15 61 160	014843	160				0.6	102
15 81 160	015574	160				0.8	102

Stripping Tools

with scalpel blade

- > For stripping all common round cables
- > Self-tightening holding lever
- > With adjusting screw for cutting depth adjustment
- > Turnable blade for circular and longitudinal cutting
- > Spare blade inside the handle
- > Secure grip due to soft component material on handle and holding lever to avoid slipping
- > Housing: plastic, impact-proof



16 20 16 SB



16 20 165 SB

16 20 165 SB

- > With knife and hook blade, protective cap included



Article No.	EAN 4003773-	↔ mm		Stripping capacities	
				Ø mm	△ g
16 20 16 SB	060451	130	MM	4 - 16	70
16 20 28 SB	060468	130		8 - 28	95
16 20 165 SB	043133	165	MM	8 - 28	85
16 29 165	043140	Spare blade for 16 20 16 SB / 16 20 28 SB / 16 20 165 SB			

Folding Knife for Electricians

Always to hand: the high-quality all-purpose cutter

- ▶ Universal folding cutter for everyday use
- ▶ Durable and robust: top quality, extremely sharp blade – Made in Solingen
- > Ergonomic handle shape for comfortable holding and easy guidance
- > Handle made from robust, shock-resistant plastic
- > Good power transmission during use
- > Stable blade
- > Tether attachment at the end of the cutter allows a fastener to be attached; also suitable for KNIPEX Tethered Tools
- > Blade made of stainless steel



16 20 50 SB

Article No.	EAN	↔ mm	Blade length mm	⚖ g
16 20 50 SB	4003773-082705	120	80	85



Easy opening thanks to the practical diamond-shaped grip on the blade



For KNIPEX Tethered Tools: the tether attachment on the handle allows a fastener to be attached



The Electricians' Folding Cutter is quickly available to hand and is suitable for all the usual cutting tasks

Stripping Tools

for spiral cutting

- > For dismantling round cable sheaths made of PVC, rubber, silicone or PTFE from 6.0 - 29.0 mm dia.
- > Self-tightening holding lever
- > With knurled nut for cutting depth adjustment
- > Changing from circular to longitudinal cutting by turning the tool body
- > Spiral cutting for removing intermediate pieces
- > Replaceable blade
- > Housing: plastic, impact-proof



16 30 145 SB



Setting the tool for circular cut



Longitudinal cut



Spiral cutting

Article No.	EAN	↔ mm	MM	Stripping capacities Ø mm	⚖ g
16 30 135 SB	033349	135		6 - 29	120
16 30 145 SB	081029	150	19 - 40	140	
16 39 135	027317	Spare blade for 16 30 135 SB / 16 30 145 SB			

Stripping Tools

- > For dismantling round cables exceeding 25.0 mm dia.
- > Removes all sheaths of standard cables
- > Suitable for longitudinal and circular cutting
- > Cutting depth can be adjusted up to 5.0 mm
- > Replaceable blade (both sides can be used)
- > Tool body: plastic, fibreglass-reinforced



16 40 150



Setting the tool for longitudinal cut



Longitudinal cut



Turning the tool for circumferential cut



Circular cut

Article No.	EAN 4003773-	↔ mm	Stripping capacities Ø mm	⚖ g
16 40 150	026709	150	> 25	210
16 49 150	026716	Spare blade for 16 40 150		



Adjustable cutting depth

Stripping Tool for coax cables

- > For stripping coax cables (RG 58, RG 59 and RG 62)
- > For stripping outer sheath, shield and insulation in a single process
- > With three built-in blades
- > The cutting depth of each blade can be adjusted individually by means of a hexagonal key (Allen key)
- > The blade spacing remains constant
- > Housing: plastic, impact-proof



16 60 05 SB

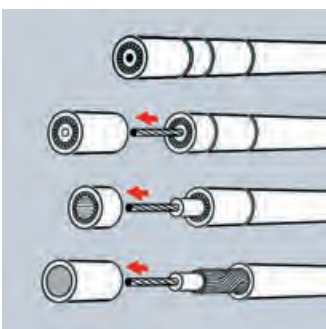

Stripping of a Coax cable in three steps

Article No.	EAN 4003773-	↔ mm		Cable type	⚖ g
16 60 05 SB	044888	105	MM	RG 58, RG 59 + RG 62	75

Wire Stripping Tool for coax and data cable

- > Universal stripping tool for Coax cables RG 59, RG 6, RG 7, RG 11
- > For stripping outer sheath, shield and insulation in a single process
- > Adjustable stripping blade for data cable
- > Two stripping blades for cutting and stripping telephone ribbon cable (4P/6P/8P) in a single operation
- > Integrated blade for cutting data cables
- > Housing: plastic, impact-proof



16 60 06 SB



Article No.	EAN 4003773-	↔ mm		Cable type	⚖ g
16 60 06 SB	077961	125	MM	RG 59, RG 6, RG 7, RG 11	100

Stripping Tool for coax cables

- > For stripping all common coax cables between 4.8 - 7.5 mm dia. (e.g. for TV- and satellite antenna), also suitable for PVC round cable 3 x 0.75 mm²
- > With length scale 5.0 - 20.0 mm
- > Double shell, folding back stripping tool
- > With opening spring and locking device
- > Body: plastic, fibreglass-reinforced



16 60 100 SB

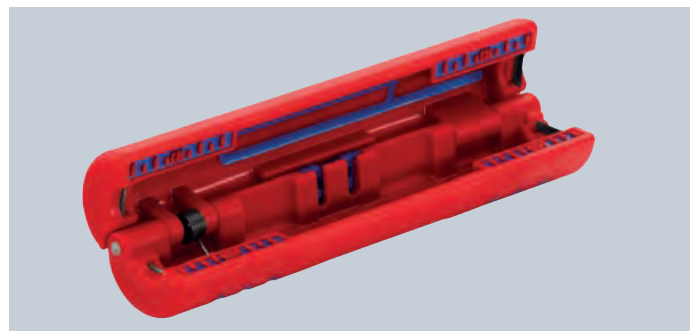
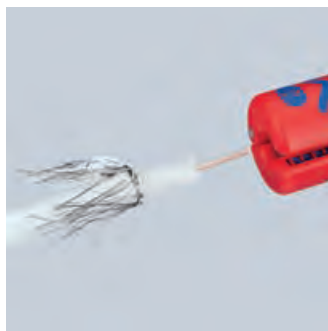

Article No.	EAN 4003773-	↔ mm	Stripping capacities Ø mm	⚖ g
16 60 100 SB	040811	100	Coax cables 4.8 - 7.5 round cables 3 x 0.75 mm ²	22

Stripping Tool for flat and round cables

- > For flat cables up to 12 mm in width
- > For stripping all common round and damp-proof installation cables Ø 4.0 to 13.0 mm (e.g. NYM cable 3 x 1.5 mm² up to 5 x 2.5 mm²)
- > Stripping device for cross-sections 0.8 / 1.5 / 2.5 mm² (AWG 20 / 16 / 14)
- > With opening spring and locking device
- > For use in confined and difficult to access work areas
- > Also for use in conduit and distribution boxes
- > Body: plastic, fibreglass-reinforced



16 64 125 SB

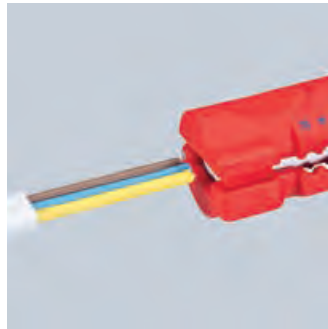

Article No.	EAN 4003773-	↔ mm	∩	Stripping capacities		Types of cables	⚖ g
				Ø mm	mm ²		
16 64 125 SB	076933	125	∩	4 - 13	0.8 - 2.5	flat cable 12 mm / round cable Ø 4 - 13 mm	48

Stripping Tool for data cables

- > For stripping UTP and STP data cables with diameters of 4.5 to 10.0 mm
- > Stripping device for cross-sections 0.2 / 0.3 / 0.8 / 1.5 / 2.5 / 4 mm²
- > Double shell, folding back stripping tool
- > With opening spring and locking device
- > Practical clip for easy transport
- > Body: plastic, fibreglass-reinforced
- > Blades: special tool steel, oil-hardened, TiN-coated



16 65 125 SB

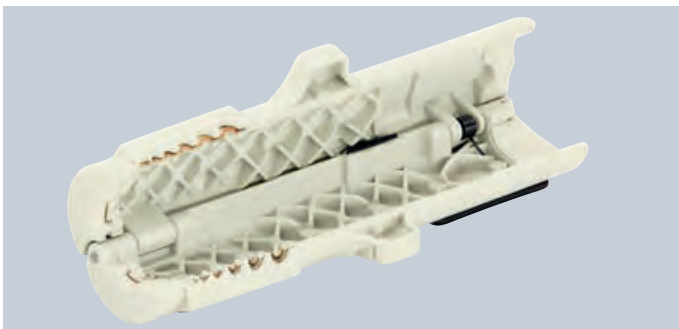

Article No.	EAN 4003773-	↔ mm	∩	Stripping capacities		Types of cables	⚖ g
				Ø mm	mm ²		
16 65 125 SB	043157	125	∩	4.5 - 10	0.2 - 4	CAT 5, CAT 6, CAT 7, Twisted-Pair (UTP/STP)	50

Universal Stripping Tools

- > For stripping all common round and damp-proof installation cables between 8.0 - 13.0 mm dia. (e.g. 3 x 1.5 mm² up to 5 x 2.5 mm²)
- > Also for use in conduit and distribution boxes
- > Double shell, folding back stripping tool
- > With opening spring and locking device
- > Practical clip for easy transport
- > Body: plastic, fibreglass-reinforced

16 85 125 SB

- > With additional blade for longitudinal cuts; telescopic blade inside; stripping device for cross-sections 0.2 / 0.3 / 0.8 / 1.5 / 2.5 / 4 mm²; with integrated cable guide for longitudinal cut. This enables rigid insulation (e.g. halogen-free) to be stripped more easily



16 80 125 SB



16 85 125 SB



Article No.	EAN 4003773-	↔ mm		Stripping capacities		Types of cables	△ g
				Ø mm	mm ²		
16 80 125 SB	040828	125	MM	8 - 13		round cable, e.g.: 3 x 1,5 mm ² up to 5 x 2,5 mm ²	75
16 85 125 SB	060444	125	MM	8 - 13	0.2 - 4	round cable, e.g.: 3 x 1,5 mm ² up to 5 x 2,5 mm ²	79

Depth Stripping Tool

- > Long, ergonomic design for work in deep connector sockets



16 80 175 SB

Article No.	EAN 4003773-	↔ mm	Stripping capacities		△ g
			Ø mm		
16 80 175 SB	084129	175	8 - 13		90

Universal Stripping Tool for building and industrial cables

- > With opening spring and locking device
- > For stripping all common round and damp-proof installation cables between 8.0 - 13.0 mm dia. (e.g. 3 x 1.5 mm² up to 5 x 2.5 mm²)
- > Also for use in conduit and distribution boxes
- > Body: plastic, fibreglass-reinforced
- > For use in confined and difficult to access work areas
- > Specially suitable for larger cross-sections and for difficult insulating materials
- > No adjustment of blades to cutting depth required
- > Stripping device for conductors and strands 1.5 mm² and 2.5 mm²
- > Two-way length stop (ideal for right and left-handers)
- > Fastening device on the end of the handle (drop protection system)



16 90 130 SB

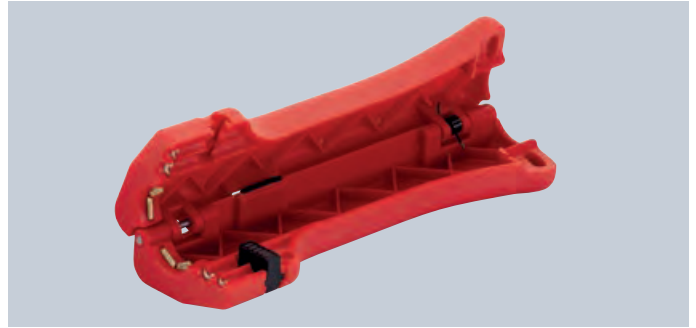

Article No.	EAN 4003773- 076940	↔ mm	↔ mm	Stripping capacities		Types of cables	⚖ g
				Ø mm	mm ²		
16 90 130 SB		130	MM	8 - 13	1.5 / 2.5	round cable, e.g.: 3 x 1,5 mm ² up to 5 x 2,5 mm ²	47

KNIPEX ErgoStrip®

Universal Stripping Tool

- ▶ For the fast and precise stripping of all common round and damp-proof installation cables (e.g. NYM cable 3 x 1.5 mm² up to 5 x 2,5 mm²), data cable (e.g. twisted pair) and coax cable
- ▶ Innovative, ergonomic pistol grip design for easy cutting, stripping and longitudinal cut of the sheath
- > Conical, slimmed down tool ends for better access in confined areas
- > Stripping device for cross-sections 0.2 / 0.3 / 0.8 / 1.5 / 2.5 / 4 mm²
- > Simplified insertion of single wires for stripping using location ridges
- > With opening spring and locking device
- > Easy insertion of coax and data cable thanks to opening aid
- > Multi-component design with a soft plastic zone for comfortable use and a secure grip
- > Housing made from stable glass fibre reinforced plastic

16 95 01 SB

- > For right-handers



16 95 01 SB



16 95 02 SB



Stripping of a coax cable



Stripping of a NYM cable



Stripping of a data cable



Stripping of a coax cable

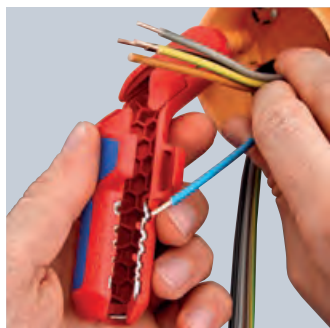

Wire stripping on single conductors



With concealed cutter in overhanging thumb rest on the side for convenient lengthwise cut

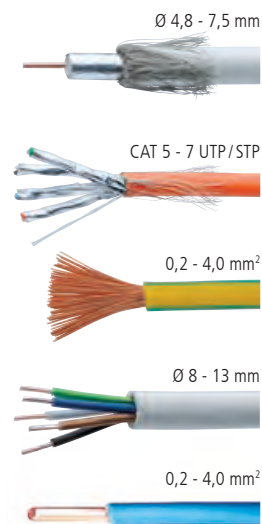

Article No.	EAN 4003773-	↔ mm	PAT. PEND.	Stripping capacities				g
				round cable Ø mm	conductors and strands mm ²	data cable	coax cable Ø mm	
16 95 01 SB	079927	135	PAT. PEND.	8 - 13	0.2 - 4	CAT 5 - 7, Twisted pair (UTP/STP)	4.8 - 7.5	75
16 95 02 SB	082910	135	PAT. PEND.	8 - 13	0.2 - 4	CAT 5 - 7, Twisted pair (UTP/STP)	4.8 - 7.5	75



Gripping and Grip Pliers

Flat Nose Pliers	46
Round Nose Pliers	47
Long Reach Needle Nose Pliers	48
Long Reach Needle Nose Pliers with transverse profiles	48
Telephone Pliers	49
Gripping Pliers (Needle Nose Pliers)	49
Long Nose Pliers	50
Relay Adjusting Pliers	51
Duckbill Pliers	51
Gripping Pliers for precision mechanics	52
Mechanics' Pliers	53
Universal Grip Pliers	54
Welding Grip Pliers	54
Grip Pliers	55



Flat Nose Pliers

- > Flat, short, wide jaws
- > Knurled gripping surfaces
- > Special tool steel, forged, oil-hardened
- > DIN ISO 5745

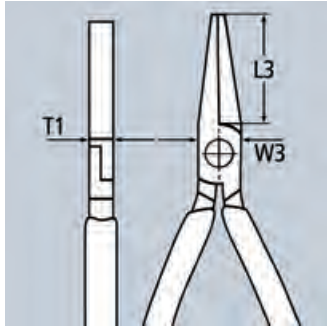

20 01 160



20 02 160



20 06 160

Article No.	EAN 4003773-	↔ mm		Pliers	Head	Handles	Dimensions			△ g
							L3 mm	W3 mm	T1 mm	
20 01 125	033875	125					27.0	14.5	8.0	80
20 01 140	022794	140					28.0	15.5	9.5	105
20 01 160	033882	160		black atramentized	polished	plastic coated	30.0	17.0	9.5	140
20 01 180	042440	180					35.0	19.0	10.0	185
20 02 140	043386	140		black atramentized	polished	with multi-component grips	28.0	15.5	9.5	137
20 02 160	035008	160		black atramentized	polished	with multi-component grips	30.0	17.0	9.5	172
20 05 140	042464	140		chrome plated	chrome plated	with multi-component grips	28.0	15.5	9.5	136
20 05 160	042457	160		chrome plated	chrome plated	with multi-component grips	30.0	17.0	9.5	176
20 06 160	033783	160		chrome plated	chrome plated	insulated with multi-component grips, VDE-tested	30.0	17.0	9.5	176

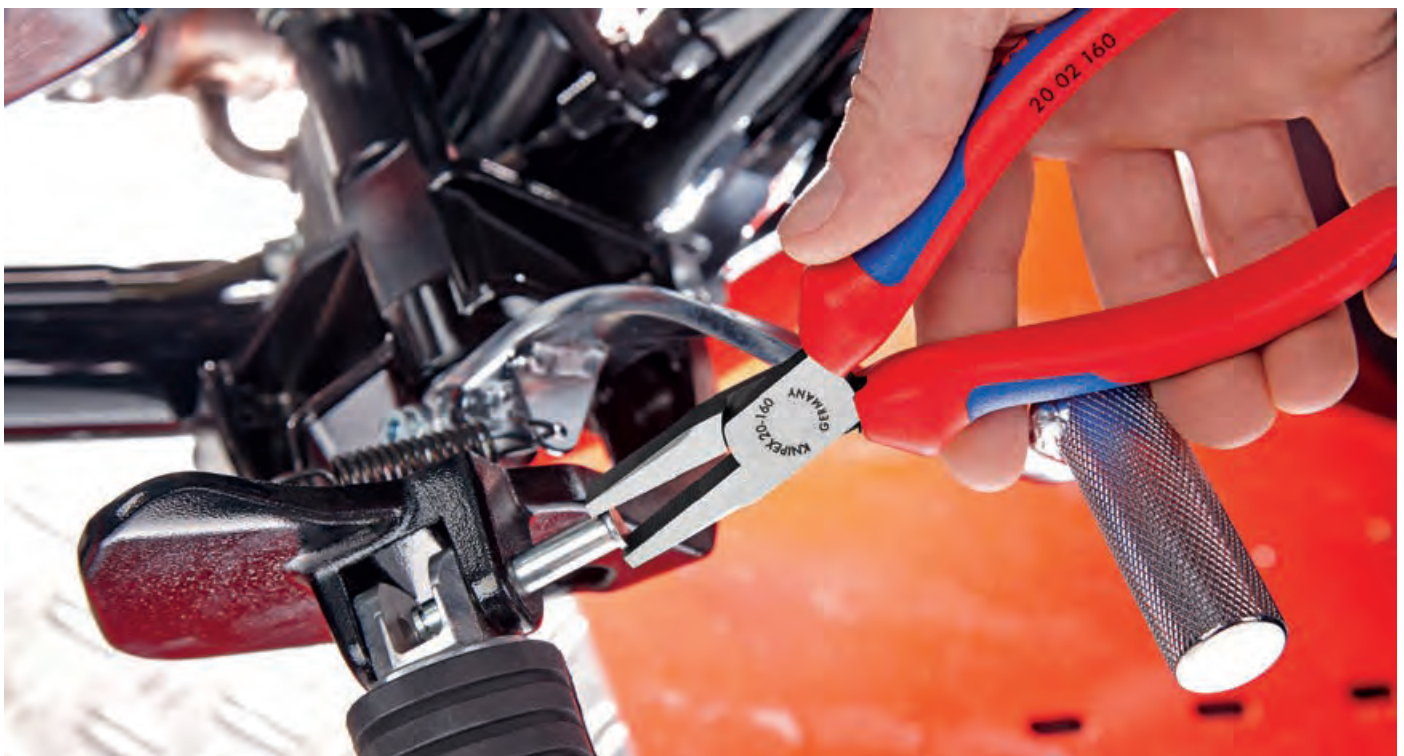

Round Nose Pliers

- > For bending wire loops
- > Round, short jaws; finely ground
- > Smooth tips
- > Special tool steel, forged, oil-hardened
- > DIN ISO 5745

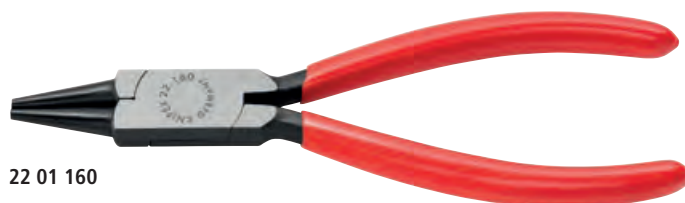
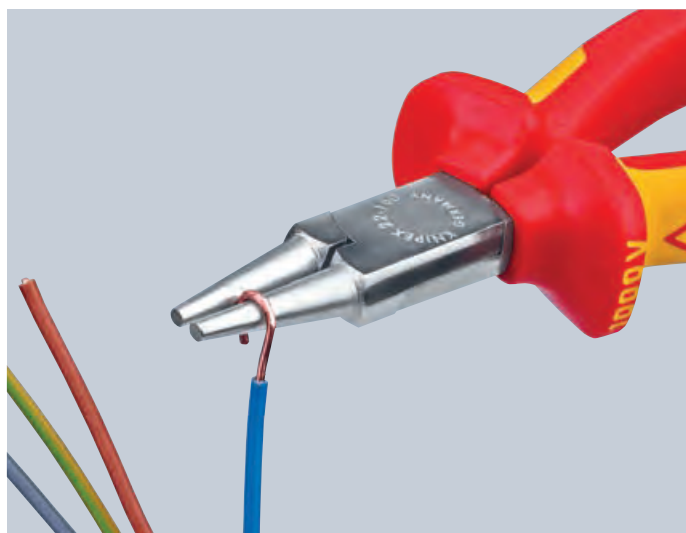
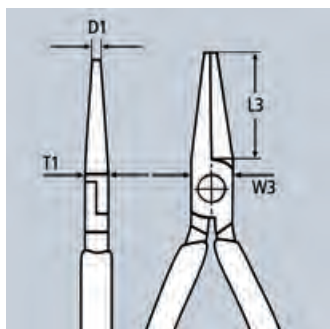

22 01 160



22 02 140



22 02 160



22 05 140

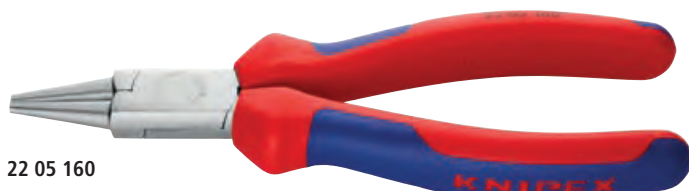

22 05 160



22 06 160

Article No.	EAN 4003773-	↔ mm		Pliers	Head	Handles	Dimensions				Δ g
							L3 mm	W3 mm	D1 mm	T1 mm	
22 01 125	033899	125					27.0	14.5	2.0	8.0	75
22 01 140	022800	140	◁ 8	black atramentized	polished	plastic coated	28.0	16.5	2.5	9.5	100
22 01 160	033905	160					30.0	18.0	3.0	9.5	135
22 02 140	043430	140	◁ 8	black atramentized	polished	with multi-component grips	28.0	16.5	2.5	9.5	129
22 02 160	023173	160					30.0	18.0	3.0	9.5	170
22 05 140	042891	140	◁ 8	chrome plated	chrome plated	with multi-component grips	28.0	16.5	2.5	9.5	127
22 05 160	042907	160					30.0	18.0	3.0	9.5	169
22 06 160	033790	160	◁ 8 ⚡ 1000V ⚠	chrome plated	chrome plated	insulated with multi-component grips, VDE-tested	30.0	18.0	3.0	9.5	175

Long Reach Needle-Nose Pliers

- > Specially suitable for gripping and assembly work with a higher prehensile power
- > Knurled gripping surfaces
- > High-grade special tool steel, forged, oil-hardened

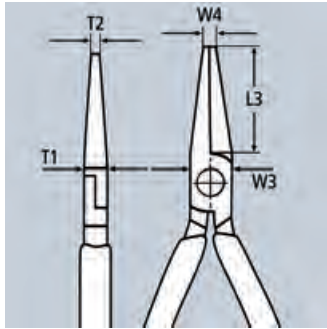

28 01 200



28 21 200

Article No.	EAN 4003773-	↔ mm	Pliers	Head	Handles	Dimensions					g	
						L3 mm	W3 mm	T1 mm	W4 mm	T2 mm		
28 01 200	044468	200		black atramentized	polished	plastic coated	33.0	13.5	10.5	4.0	10.5	197
28 21 200	028246	200		black atramentized	polished	plastic coated	34.0	13.5	10.5	3.0	3.0	187

Long Reach Needle-Nose Pliers

with transverse profiles

Long Reach Needle-Nose Pliers with wave profile

- ▶ For gripping, adjustment and assembly work in hard to reach areas thanks to slim, very long design
- ▶ Deep down situated parts can be easily reached using the slim, half-round tips
- > Careful yet reliable gripping, holding and guiding of small copper pipes, screws and cables as well as other round parts thanks to milled grooves with smooth surfaces
- > Serrated pipe grip to grip round parts
- > Particularly suitable for work in the automotive trade and in mechanical engineering
- > Slim yet robust tool
- > Forged from special tool steel, oil-hardened and tempered
- > DIN ISO 5745



28 71 280



28 81 280

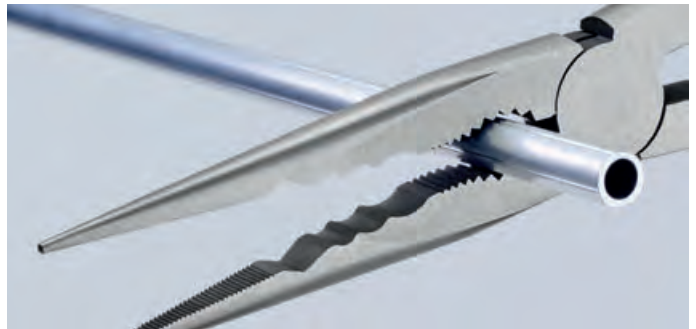

Wave-shaped gripping profile: transverse profile for gripping, holding and guiding

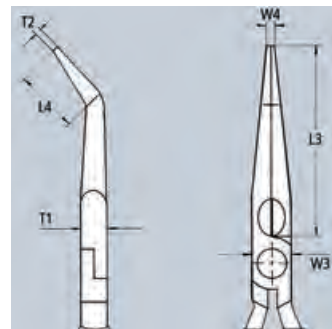
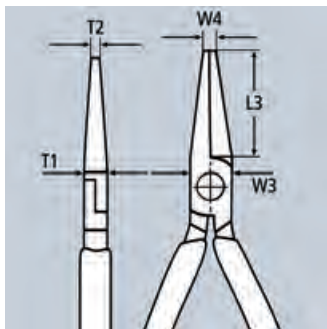

Article No.	EAN 4003773-	↔ mm	Pliers	Head	Handles	Dimensions					g	
						L3 mm	L4 mm	W3 mm	T1 mm	W4 mm		T2 mm
28 71 280	079415	280		polished	plastic coated	76.5		20.0	9.0	3.0	2.5	235
28 81 280	079422	280	$\angle 45^\circ$	polished	plastic coated	70.0	20.0	20.0	9.0	2.5	2.5	235

Telephone Pliers

- > Gripping surfaces cross-hatched, knurled
- > Chrome vanadium electric steel, forged, oil-hardened
- > DIN ISO 5745

29 21 160 / 29 25 160

- > Extra slim, fine tips; also suitable for soldering work

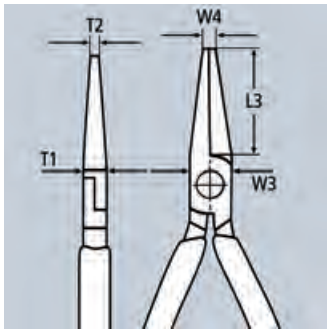

29 11 160



29 21 160

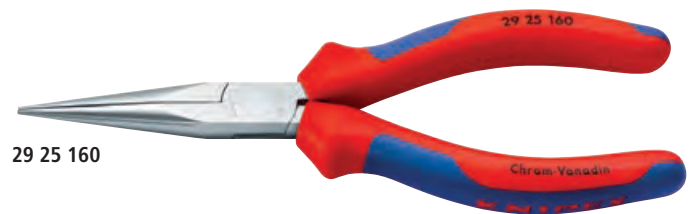

29 25 160

Article No.	EAN	↔ mm		Pliers	Head	Handles	Dimensions					Δ _g
							L3 mm	W3 mm	T1 mm	W4 mm	T2 mm	
29 11 160	016175	160		black atramentized	polished	plastic coated	55.0	14.0	8.0	2.5	8.5	103
29 21 160	043454	160		black atramentized	polished	plastic coated	54.0	14.0	9.0	2.0	2.0	112
29 25 160	043478	160		chrome plated	chrome plated	with multi-component grips	54.0	14.0	9.0	2.0	2.0	139

Gripping Pliers

Needle-Nose Pliers

- > Precision pliers for very exact assembly, bending and adjusting work
- > With extra long jaws: length of jaws 55.0 mm
- > Smooth ground gripping surfaces
- > Edges carefully deburred
- > Chrome vanadium electric steel, forged, oil-hardened

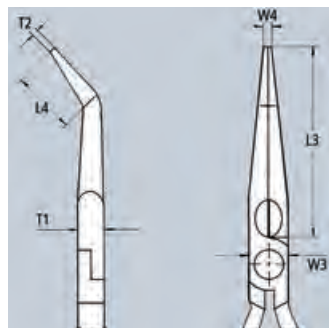
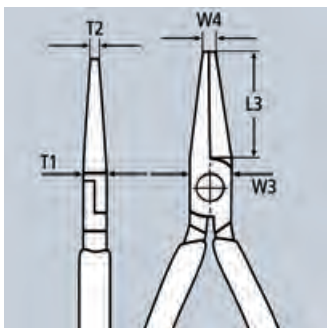

31 11 160

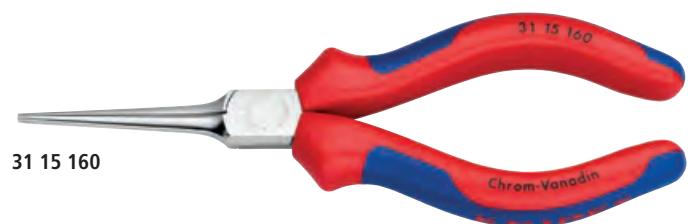

31 15 160

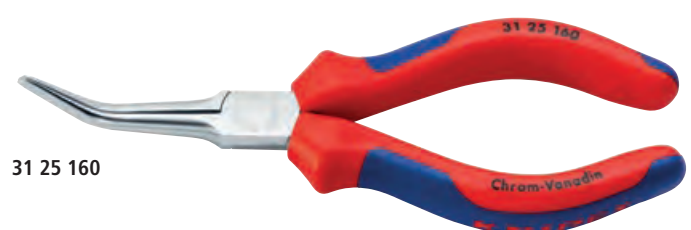

31 25 160

Article No.	EAN	↔ mm		Pliers	Head	Handles	Dimensions					Δ _g	
							L3 mm	L4 mm	W3 mm	T1 mm	W4 mm		T2 mm
31 11 160	044475	160		black atramentized	polished	plastic coated	55.0		16.0	7.5	1.8	2.5	100
31 15 160	016465	160		chrome plated	chrome plated	with multi-component grips	55.0		16.0	7.5	1.8	2.5	124
31 21 160	046790	160		black atramentized	polished	plastic coated	55.0	27.0	16.0	7.5	1.8	2.5	97
31 25 160	016489	160		chrome plated	chrome plated	with multi-component grips	55.0	27.0	16.0	7.5	1.8	2.5	123

Long Nose Pliers

- > Heavy duty and wear resisting
- > Different jaw styles
- > Chrome vanadium electric steel, forged, oil-hardened
- > DIN ISO 5745

Style 1

- > Long, trapezoidal jaws; knurled gripping surfaces

Style 2

- > Long, half-round jaws; knurled gripping surfaces

Style 3

- > Long, round jaws; smooth gripping surfaces

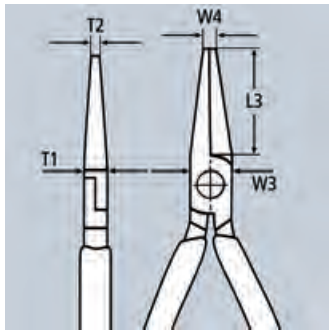

30 11 160

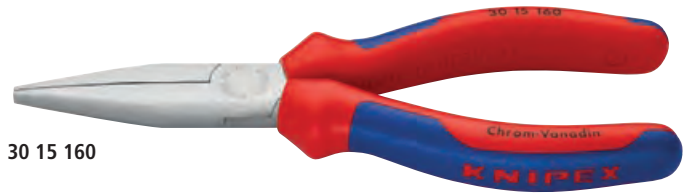

30 15 160



30 16 160



30 25 160



30 31 160

Article No.	EAN	↔ mm		Style	Pliers	Head	Handles	Dimensions					⚖ g
								L3 mm	W3 mm	T1 mm	W4 mm	T2 mm	
30 11 140	033936	140		1				42.0	15.0	8.0	2.5	4.0	86
30 11 160	023128	160		1	black atramentized	polished	plastic coated	46.5	16.5	9.5	3.0	5.0	121
30 11 190	043492	190		1				50.0	18.5	9.5	3.0	7.0	145
30 13 140	016298	140		1	chrome plated	chrome plated	plastic coated	42.0	15.0	8.0	2.5	4.0	87
30 13 160	043485	160		1				46.5	16.5	9.5	3.0	5.0	118
30 15 140	042914	140		1				42.0	15.0	8.0	2.5	4.0	106
30 15 160	035046	160		1	chrome plated	chrome plated	with multi-component grips	46.5	16.5	9.5	3.0	5.0	149
30 15 190	001881	190		1				50.0	18.5	8.0	3.0	7.0	171
30 16 160	001904	160	 	1	chrome plated	chrome plated	insulated with multi-component grips, VDE-tested	46.5	16.5	9.5	3.0	5.0	150
30 21 140	042433	140		2				42.0	15.0	8.0	2.5	2.0	95
30 21 160	035053	160		2	black atramentized	polished	plastic coated	50.0	16.5	9.5	3.0	2.5	121
30 21 190	043508	190		2				50.0	18.5	8.0	3.0	2.4	145
30 23 140	016373	140		2	chrome plated	chrome plated	plastic coated	42.0	15.0	8.0	2.5	2.0	95
30 25 140	001980	140		2				42.0	15.0	8.0	2.5	2.0	114
30 25 160	035060	160		2	chrome plated	chrome plated	with multi-component grips	50.0	16.5	9.5	3.0	2.5	151
30 25 190	043515	190		2				50.0	18.5	8.0	3.0	2.4	168
30 31 160	035077	160		3	black atramentized	polished	plastic coated	41.0	16.5	9.5	5.0	2.5	110
30 33 160	043539	160		3	chrome plated	chrome plated	plastic coated	41.0	16.5	9.5	5.0	2.5	111
30 35 140	043102	140		3	chrome plated	chrome plated	with multi-component grips	37.5	15.0	8.0	4.0	2.0	102
30 35 160	035084	160		3				41.0	16.5	9.5	5.0	2.5	138
30 36 160	002123	160	 	3	chrome plated	chrome plated	insulated with multi-component grips, VDE-tested	41.0	16.5	9.5	5.0	2.5	141

Relay Adjusting Pliers

- > For gripping components and wires of the smallest diameters and for bending contact and relay springs
- > Polished gripping surfaces
- > Edges carefully deburred
- > High-grade special tool steel, forged, oil-hardened

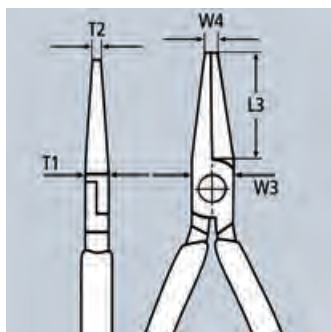

32 11 135

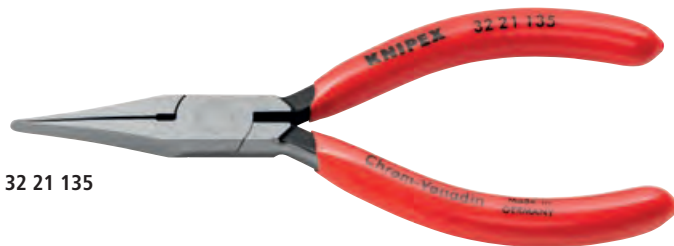

32 21 135

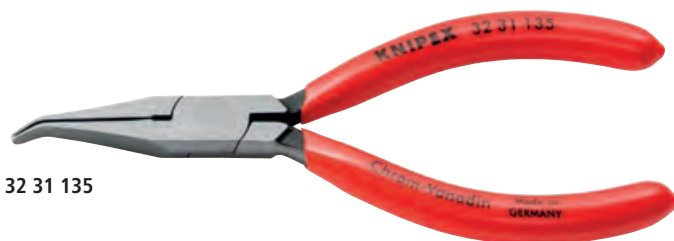

32 31 135

Article No.	EAN 4003773-	↔ mm	Pliers	Head	Handles	Dimensions					Δ g
						L3 mm	W3 mm	T1 mm	W4 mm	T2 mm	
32 11 135	035091	135	black atramentized	polished	plastic coated	34.0	12.5	7.0	1.0	1.5	73
32 21 135	043553	135	black atramentized	polished	plastic coated	34.0	12.5	7.0	1.0	3.5	74
32 31 135	043560	135	40° black atramentized	polished	plastic coated	32.0	12.5	7.0	1.0	3.5	73

Duckbill Pliers

- > Duckbill shaped jaws 9 mm wide at the tip and tapering to 1.5 mm thickness
- > Smooth gripping surfaces
- > Chrome vanadium electric steel, forged, oil-hardened

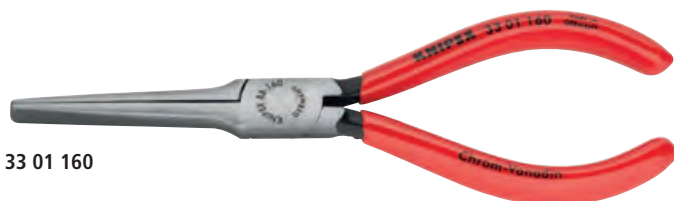
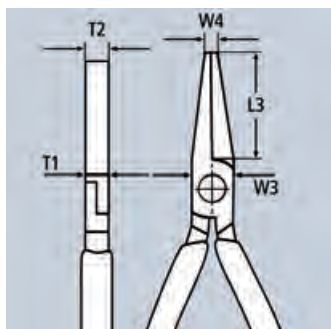

33 01 160

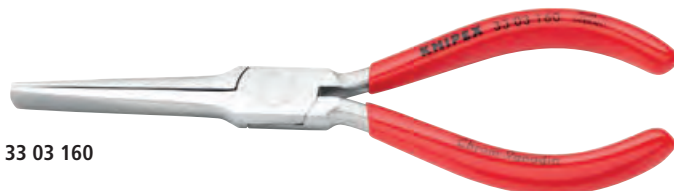

33 03 160

Article No.	EAN 4003773-	↔ mm	Pliers	Head	Handles	Dimensions					Δ g
						L3 mm	W3 mm	T1 mm	W4 mm	T2 mm	
33 01 160	016663	160	black atramentized	polished	plastic coated	55.0	15.0	7.5	3.0	9.0	103
33 03 160	016670	160	chrome plated	chrome plated	plastic coated	55.0	15.0	7.5	3.0	9.0	103

Gripping Pliers

for precision mechanics

- > Precision pliers for fine assembly work, e.g. in electronics and fine mechanics
- > For gripping, holding, bending and adjusting
- > Tips precision-ground
- > Smooth gripping surfaces
- > Edges carefully deburred
- > Lap joint
- > High-grade special tool steel, forged, oil-hardened
- > DIN ISO 9655

Style 1

- > Flat, wide jaws

Style 2

- > Flat, concave and pointed jaws

Style 3

- > Half-round jaws



37 11 125



37 13 125



37 21 125



37 23 125

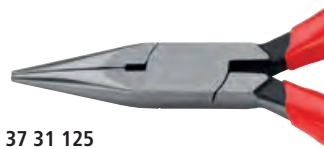

37 31 125



37 33 125



37 41 125



37 43 125

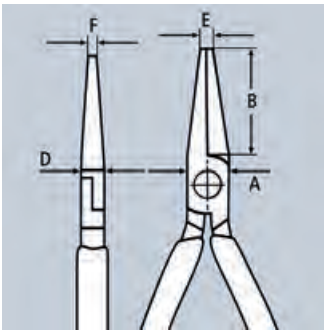

Article No.	EAN 4003773-	↔ mm		Style	Pliers	Head	Handles	Dimensions					⚖ g
								B mm	A mm	D mm	E mm	F mm	
37 11 125	014287	125		1	black atramentized	polished	plastic coated	27.0	12.5	7.0	2.0	5.5	76
37 13 125	043638	125		1	chrome plated	chrome plated	plastic coated	27.0	12.5	7.0	2.0	5.5	71
37 21 125	035138	125		2	black atramentized	polished	plastic coated	27.0	12.5	7.0	2.0	2.0	74
37 23 125	043645	125		2	chrome plated	chrome plated	plastic coated	27.0	12.5	7.0	2.0	2.0	72
37 31 125	035145	125		3	black atramentized	polished	plastic coated	27.0	12.5	7.0	2.0	1.6	74
37 33 125	016960	125		3	chrome plated	chrome plated	plastic coated	27.0	12.0	7.0	2.0	1.6	78
37 41 125	035152	125		4	black atramentized	polished	plastic coated	27.0	14.5	8.0	2.0	1.0	76
37 43 125	043652	125		4	chrome plated	chrome plated	plastic coated	27.0	14.5	8.0	2.0	1.0	76

Mechanics' Pliers

- > High bending strength of the pliers tips
- > Gripping surfaces cross-hatched, knurled
- > Vanadium electric steel; forged, oil-hardened
- > DIN ISO 5745

Style 2

- > 40° angled jaws

Style 3

- > Curved tip

38 35 200 T*

- > Pliers with tether attachment point for mounting a fall protection

38 71 200

- > 70° angled, half-round jaws, suitable for pulling split pins; for gripping at points that are difficult to access

38 91 200 / 38 95 200

- > 45° angled, half-round, long jaws, also suitable for gripping spark plugs and round components (spark plug cover "grabber")

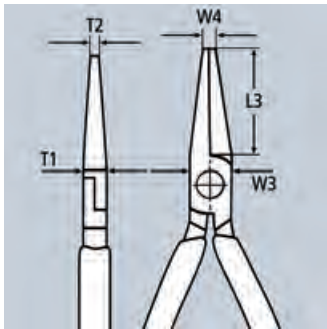

38 11 200



38 15 200



38 21 200



38 25 200



38 31 200



38 35 200



38 41 190

Article No.	EAN	↔ mm		Pliers	Head	Handles	Dimensions					Δ g
							L3 mm	W3 mm	T1 mm	W4 mm	T2 mm	
38 11 200	035169	200	⊗ ⊖	black atramentized	polished	plastic coated	73.0	17.5	9.5	3.0	2.5	179
38 15 200	039594	200	⊗ ⊖	chrome plated	chrome plated	with multi-component grips	73.0	17.5	9.5	3.0	2.5	209
38 21 200	035176	200	⊗ ⊖ ∠40°	black atramentized	polished	plastic coated	73.0	17.5	9.5	3.0	2.5	175
38 25 200	043669	200	⊗ ⊖ ∠40°	chrome plated	chrome plated	with multi-component grips	73.0	17.5	9.5	3.0	2.5	209
38 31 200	040712	200	⊗ ⊖	black atramentized	polished	plastic coated	73.0	17.5	9.5	3.0	2.5	176
38 35 200	017134	200	⊗ ⊖	chrome plated	chrome plated	with multi-component grips	73.0	17.5	9.5	3.0	2.5	205
38 35 200 T	083771	200	⊗ ⊖	chrome plated	chrome plated	with multi-component grips, with integrated tether attachment point for a tool tether	73.0	17.5	9.5	3.0	2.5	210
38 41 190	017141	190	⊗ ⊖ 	black atramentized	polished	plastic coated	50.0	18.0	8.0	4.0	8.0	139
38 45 190	043676	190	⊗ ⊖ 	chrome plated	chrome plated	with multi-component grips	50.0	18.0	8.0	4.0	8.0	171
38 71 200	017202	200	⊗ ⊖ ∠70°	black atramentized	polished	plastic coated	73.0	17.5	9.5	3.0	2.0	174
38 91 200	017219	200	⊗ ⊖ ∠45°	black atramentized	polished	plastic coated	73.0	17.5	9.5		2.5	177
38 95 200	017233	200	⊗ ⊖ ∠45°	chrome plated	chrome plated	with multi-component grips	73.0	17.5	9.5		2.5	207

*Other tools with tethering can be found from page 266

Universal Grip Pliers

- > Hold round, profile and flat material securely
- > Heavy duty model
- > With adjustment screw and release lever
- > One-hand operation
- > High clamping pressure due to toggle lever action
- > Pliers body: rolled steel, high-strength
- > Gripping jaws: chrome vanadium electric steel, forged

40 04 250

- > With one pivoting jaw



40 04 250



40 14 250

Article No.	EAN 4003773-	↔ mm		Pliers	○ mm	□ mm	⬡ mm	⚖ g
40 04 180	022190	180		galvanized	35	25	32	310
40 04 250	002710	250		galvanized	35	30	32	521
40 14 250	080329	250		galvanized	43	42	45	600

Welding Grip Pliers

- > For gripping, clamping and holding of diverse profiles
- > Heavy duty model
- > With adjustment screw and release lever
- > One-hand operation
- > High clamping pressure due to toggle lever action
- > Pliers body: rolled steel, high-strength

42 14 280

- > Heat resistant malleable cast iron jaws; section or flat material items lying side by side are held in place during welding; also for section material with vertical webs up to 15 mm height

42 24 280

- > Heat resistant malleable cast iron jaws; round or tubular material items lying centrally side by side are held securely during welding

42 34 280

- > Gripping jaws of chrome vanadium steel, drop forged; clamps cumbersome workpieces and sections with high webs up to 40 mm

42 44 280

- > With moveable jaws; gripping jaws of chrome vanadium steel, drop forged; clamps and balances bulky work components and profiles with high ridges of up to 40 mm



42 14 280



42 24 280



42 34 280



42 44 280



Article No.	EAN 4003773-	↔ mm	Pliers	○ mm	□ mm	⚖ g
42 14 280	022206	280	galvanized	30 - 65	50	917
42 24 280	022213	280	galvanized	10 - 70		850
42 34 280	022220	280	galvanized		90	692
42 44 280	080350	280	galvanized		90	740

Grip Pliers

- > Hold round, profile and flat material securely
- > Heavy duty model
- > With adjustment screw and release lever
- > One-hand operation
- > High clamping pressure due to toggle lever action
- > Pliers body: rolled steel, high-strength
- > Gripping jaws: chrome vanadium electric steel, forged

Style 0

- > Jaws for round workpieces, with wire cutter

Style 1

- > Jaws with double prism for round, section and flat material

Style 2

- > Straight jaws for flat material

Style 3

- > Long-Nose Grip Pliers, narrow, long jaws

Style 4

- > Long-Nose Grip Pliers, narrow, long jaws;
very suitable for areas that are difficult to reach;
non-serrated gripping area for pinching off hoses



41 04 250



41 14 250



41 24 225



41 34 165



41 44 200



Article No.	EAN 4003773-	↔ mm		Style	Pliers	○ mm	□ mm	⬡ mm	△ g
41 04 180	002741	180		0	galvanized	30	20	30	363
41 04 250	002758	250	▨	0		40	20	30	517
41 04 300	022183	300		0		65	30	34	923
41 14 250	023470	250	▨	1	galvanized	36	36	36	557
41 24 225	023487	225	▨	2	galvanized	25	16	30	504
41 34 165	047858	165	▨	3	galvanized	20	10	24	189
41 44 200	080343	200	▨	4	galvanized	20	20	30	400

Circlip Pliers



Circlip Pliers for internal circlips in bore holes	58
Circlip Pliers for external circlips on shafts	59
Precision Circlip Pliers for internal circlips in bore holes	60
– with overstretching limiter	61
Precision Circlip Pliers for external circlips on shafts	62
– with overstretching limiter	63
Circlip Pliers for large internal circlips up to 400 mm	64
Circlip Pliers for large external circlips up to 400 mm	64
Circlip Tool for circlips up to 1000 mm	65
Special Retaining Ring Pliers for retaining rings on shafts	66
Circlip Pliers for grip rings on shafts	66
Sets of Circlip Pliers	67
Pliers Sets in a foam tray	69
Precision Circlip Pliers Sets	70
Tool Box "SRZ"	71

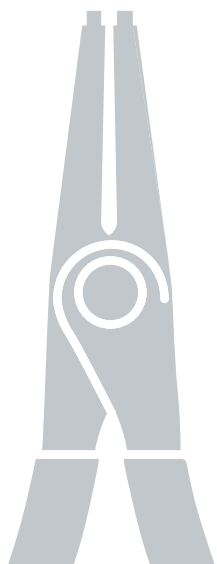

Circlip Pliers

for internal circlips in bore holes



- > Slim pattern, forged
- > Non-slip, solid tips
- > Pliers body and tips: chrome vanadium steel, forged, oil-hardened



44 11 J2



44 13 J2



44 21 J21



44 23 J21



44 31 J22

Style 1
> DIN 5256 C, straight tips

Style 2
> DIN 5256 D; 90° angled tips

Style 3
> 45° angled tips

Article No.	EAN	↔ mm	↻	Style	Pliers	Head	Handles	Size of bore Ø mm	Tips Ø mm	△ g
44 11 J0	040286	140	↻	1	black atramentized	polished	plastic coated	8 - 13	0.9	88
44 11 J1	022862	140		1				12 - 25	1.3	88
44 11 J2	022879	180		1				19 - 60	1.8	135
44 11 J3	033943	225		1				40 - 100	2.3	196
44 11 J4	042549	320		1				85 - 140	3.2	469
44 13 J0	048176	140	↻	1	chrome plated	chrome plated	plastic coated	8 - 13	0.9	89
44 13 J1	042938	140		1				12 - 25	1.3	88
44 13 J2	042945	180		1				19 - 60	1.8	138
44 13 J3	042952	225		1				40 - 100	2.3	194
44 13 J4	017301	320		1				85 - 140	3.2	463
44 21 J01	040132	130	↻	2	black atramentized	polished	plastic coated	8 - 13	0.9	88
44 21 J11	022886	130		2				12 - 25	1.3	88
44 21 J21	022893	170		2				19 - 60	1.8	139
44 21 J31	033769	215		2				40 - 100	2.3	196
44 21 J41	043683	300		2				85 - 140	3.2	462
44 23 J11	042969	130	↻	2	chrome plated	chrome plated	plastic coated	12 - 25	1.3	89
44 23 J21	042976	170		2				19 - 60	1.8	138
44 23 J31	042983	215		2				40 - 100	2.3	200
44 31 J02	066941	140	↻	3	black atramentized	polished	plastic coated	8 - 13	0.9	90
44 31 J12	066958	140		3				12 - 25	1.3	90
44 31 J22	066965	180		3				19 - 60	1.8	140
44 31 J32	066972	225		3				40 - 100	2.3	195
44 31 J42	066989	310		3				85 - 140	3.2	465

Circlip Pliers

for external circlips on shafts

- > Slim pattern, forged
- > Non-slip, solid tips
- > Pliers body and tips: chrome vanadium steel, forged, oil-hardened



46 13 A2



46 21 A21



46 31 A22

Style 1

- > DIN 5254 A; straight tips

Style 2

- > DIN 5254 B; 90° angled tips

Style 3

- > 45° angled tips

Article No.	EAN	↔ mm		Style	Pliers	Head	Handles	Size of shaft Ø mm	Tips Ø mm	Δ g
46 11 A0	033950	140	MM ○	1	black atramentized	polished	plastic coated	3 - 10	0.9	85
46 11 A1	022909	140		1				10 - 25	1.3	86
46 11 A2	022916	180		1				19 - 60	1.8	134
46 11 A3	033974	210		1				40 - 100	2.3	220
46 11 A4	042532	320		1				85 - 140	3.2	505
46 13 A0	017417	140	MM ○	1	chrome plated	chrome plated	plastic coated	3 - 10	0.9	85
46 13 A1	042990	140		1				10 - 25	1.3	82
46 13 A2	043003	180		1				19 - 60	1.8	133
46 13 A3	043010	210		1				40 - 100	2.3	211
46 21 A01	033967	125		90° MM ○				2	black atramentized	polished
46 21 A11	023005	125	2		10 - 25	1.3	85			
46 21 A21	022923	170	2		19 - 60	1.8	132			
46 21 A31	033981	200	2		40 - 100	2.3	219			
46 21 A41	039365	300	2		85 - 140	3.2	510			
46 23 A01	017509	125	90° MM ○	2	chrome plated	chrome plated	plastic coated	3 - 10	0.9	84
46 23 A11	043027	125		2				10 - 25	1.3	84
46 23 A21	043034	170		2				19 - 60	1.8	132
46 23 A31	043041	200		2				40 - 100	2.3	221
46 31 A02	066996	130		45° MM ○				3	black atramentized	polished
46 31 A12	067009	130	3		10 - 25	1.3	85			
46 31 A22	067016	185	3		19 - 60	1.8	133			
46 31 A32	067023	210	3		40 - 100	2.3	213			
46 31 A42	067030	310	3		85 - 140	3.2	511			

Precision Circlip Pliers

for internal circlips in bore holes



► Heavy duty in continuous operation: up to 10 times longer service life compared to turned tips

► With inserted tips for reliable work

- > Bolted joint: precise, zero backlash operation of pliers
- > Non-slip plastic coating on the handles
- > Inserted tips: spring steel wire, drawn
- > Pliers body: chrome vanadium electric steel, forged, oil-hardened



48 11 J2



48 21 J21

Style 1

> DIN 5256 C, straight tips

Style 2

> DIN 5256 D; 90° angled tips

High precision quality

Easy and reliable assembly: form-fitting inserted and pressed-in tips made of high-density spring steel offer a high level of protection against excessive stress and strain, e.g. when removing stuck rings. The large supporting surfaces and the position of the tips make it more difficult for the rings to bounce off.



KNIPEX circlip pliers with overexpansion guard

For the standardized fitting of circlips in the industrial serial production. Particularly manufacturers of sensitive, safety-relevant components (e.g. brakes or gears) highly appreciate the compliance of DIN 471 and 472. The mounting of circlip rings in this case requires pliers with overexpansion guard or a cone. KNIPEX Circlip Pliers with overexpansion guard meet the requirements and furthermore offer a superior durability.



Sturdy, inserted tips: made from high-density spring steel

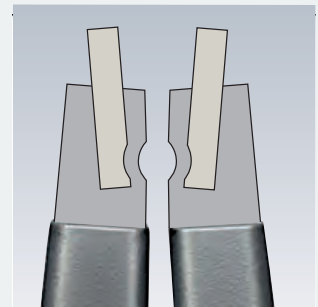

Tight fit through compression

Article No.	EAN 4003773-	↔ mm		Style	Pliers	Handles	Size of bore Ø mm	Tips Ø mm	△ g
48 11 J0	048510	140	☺	1	grey atramentized	with non-slip plastic coating	8 - 13	0.9	105
48 11 J1	048527	140		1			12 - 25	1.3	105
48 11 J2	048534	180		1			19 - 60	1.8	175
48 11 J3	048541	225		1			40 - 100	2.3	266
48 11 J4	048558	320		1			85 - 140	3.2	580
48 21 J01	048619	130	⚡☺	2	grey atramentized	with non-slip plastic coating	8 - 13	0.9	105
48 21 J11	048633	130		2			12 - 25	1.3	105
48 21 J21	048640	165		2			19 - 60	1.8	175
48 21 J31	048657	210		2			40 - 100	2.3	265
48 21 J41	048664	305		2			85 - 140	3.2	576

- ▶ With overstretching limiter
- ▶ For all circlips with a diameter of 8 - 100 mm

- > With overstretching limiter for standardized assembly according to DIN 472
- > The adjustable stop screw prevents overexpansion
- > Adjustment using hexagonal screw
- > Ideal for series production as excessive expansion of rings is effectively prevented

Style 3

- > DIN 5256 C, straight tips

Style 4

- > DIN 5256 D; 90° angled tips



48 31 J3



48 41 J21

KNIPEX circlip pliers with overexpansion guard

For the standardized fitting of circlips in the industrial serial production. Particularly manufacturers of sensitive, safety-relevant components (e.g. brakes or gears) highly appreciate the compliance of DIN 471 and 472. The mounting of circlip rings in this case requires pliers with overexpansion guard or a cone. KNIPEX Circlip Pliers with overexpansion guard meet the requirements and furthermore offer a superior durability.

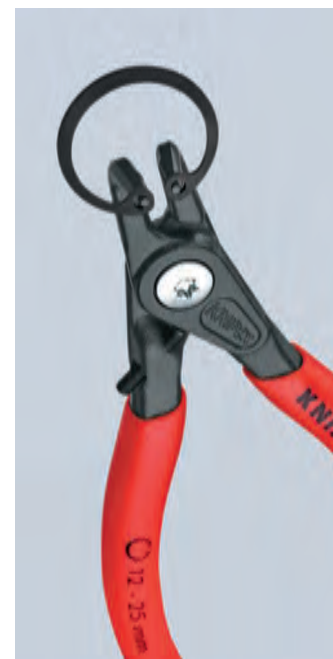

Article No.	EAN 4003773-	↔ mm		Style	Pliers	Handles	Size of bore Ø mm	Tips Ø mm	△ g
48 31 J0	079552	140	C	3	grey atramentized	with non-slip plastic coating	8 - 13	0.9	105
48 31 J1	073864	140		3			12 - 25	1.3	105
48 31 J2	073871	180		3			19 - 60	1.8	175
48 31 J3	073888	225		3			40 - 100	2.3	266
48 41 J01	079569	130	90° C	4	grey atramentized	with non-slip plastic coating	8 - 13	0.9	105
48 41 J11	079576	130		4			12 - 25	1.3	105
48 41 J21	080695	165		4			19 - 60	1.8	175
48 41 J31	079590	210		4			40 - 100	2.3	265

Precision Circlip Pliers

for external circlips on shafts



► Heavy duty in continuous operation: up to 10 times longer service life compared to turned tips

► With inserted tips for reliable work

- > Large contact faces on the tips: no distortion of circlips, easy fitting
- > Bolted joint: precise, zero backlash operation of pliers
- > Internal opening spring, protected and captive
- > Non-slip plastic coating on the handles
- > Precise, smoothly-operating screw joint
- > Slim head style allows use in confined areas
- > Handles with non-slip plastic coating
- > Inserted tips: spring steel wire, drawn
- > Pliers body: chrome vanadium electric steel, forged, oil-hardened

Style 1

> DIN 5254 A; straight tips

Style 2

> DIN 5254 B; 90° angled tips



49 11 A2



49 21 A21

High precision quality

Easy and reliable assembly: form-fitting inserted and pressed-in tips made of high-density spring steel offer a high level of protection against excessive stress and strain, e.g. when removing stuck rings. The large supporting surfaces and the position of the tips make it more difficult for the rings to bounce off.



Spring inside the joint: the spring is protected inside the precisely bolted joint. It does not hinder work and cannot get dirty or lost.



KNIPEX Precision Circlip Pliers: fit circlips without distortion; easy and quick assembling

KNIPEX circlip pliers with overexpansion guard

For the standardized fitting of circlips in the industrial serial production. Particularly manufacturers of sensitive, safety-relevant components (e.g. brakes or gears) highly appreciate the compliance of DIN 471 and 472. The mounting of circlip rings in this case requires pliers with overexpansion guard or a cone. KNIPEX Circlip Pliers with overexpansion guard meet the requirements and furthermore offer a superior durability.



Sturdy, inserted tips: made from high-density spring steel

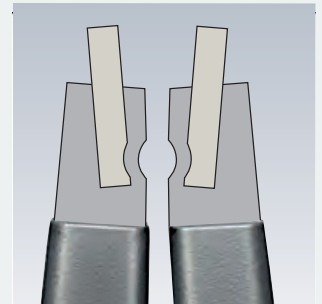

Tight fit through compression

Article No.	EAN 4003773-	↔ mm		Style	Pliers	Handles	Size of shaft Ø mm	Tips Ø mm	⚖ g
49 11 A0	048718	140	MM ○	1	grey atramentized	with non-slip plastic coating	3 - 10	0.9	101
49 11 A1	048725	140		1			10 - 25	1.3	100
49 11 A2	048732	180		1			19 - 60	1.8	170
49 11 A3	048749	225		1			40 - 100	2.3	270
49 11 A4	048756	320		1			85 - 140	3.2	599
49 21 A01	048817	130	90° MM ○	2	grey atramentized	with non-slip plastic coating	3 - 10	0.9	100
49 21 A11	048824	130		2			10 - 25	1.3	102
49 21 A21	048831	165		2			19 - 60	1.8	169
49 21 A31	048848	210		2			40 - 100	2.3	272
49 21 A41	048855	305		2			85 - 140	3.2	601

► With overstretching limiter

► For all circlips with a diameter of 3 - 100 mm

- > With overstretching limiter for standardized assembly according to DIN 471
- > The adjustable stop screw prevents overexpansion
- > Adjustment using hexagonal screw
- > Ideal for series production as excessive expansion of rings is effectively prevented

Style 3

- > DIN 5254 A; straight tips, with overstretching limiter for standardized assembly according to DIN 471: the adjustable stop screw prevents overexpansion

Style 4

- > 90° angled tips; with overstretching limiter for standardized assembly in accordance with DIN 471; the adjustable stop screw prevents the rings from overstretching



49 31 A0



49 41 A01

KNIPEX circlip pliers with overexpansion guard

For the standardized fitting of circlips in the industrial serial production. Particularly manufacturers of sensitive, safety-relevant components (e.g. brakes or gears) highly appreciate the compliance of DIN 471 and 472. The mounting of circlip rings in this case requires pliers with overexpansion guard or a cone. KNIPEX Circlip Pliers with overexpansion guard meet the requirements and furthermore offer a superior durability.



Article No.	EAN 4003773-	↔ mm		Style	Pliers	Handles	Size of shaft Ø mm	Tips Ø mm	△ g
49 31 A0	061748	140	MM ○	3	grey atramentized	with non-slip plastic coating	3 - 10	0.9	103
49 31 A1	073895	140		3			10 - 25	1.3	100
49 31 A2	073901	180		3			19 - 60	1.8	170
49 31 A3	073918	225		3			40 - 100	2.3	270
49 41 A01	061755	130	△90° MM ○	4	grey atramentized	with non-slip plastic coating	3 - 10	0.9	102
49 41 A11	079606	130		4			10 - 25	1.3	102
49 41 A21	079613	165		4			19 - 60	1.8	169
49 41 A31	079620	210		4			40 - 100	2.3	272

Circlip Pliers

for large internal circlips

- > With locking device, can be released
- > With replaceable tips made of tempered steel
- > Black powder-coated
- > Pliers body: rolled steel, high-strength
- > Tips: special tool steel, oil-hardened

Style 1

- > DIN 5256 C, straight tips

Style 2

- > DIN 5256 D; 90° angled tips



44 10 J5



44 20 J61

Article No.	EAN 4003773-	↔ mm		Style	Pliers	Size of bore Ø mm	Tips Ø mm	Δ g
44 10 J5	024910	570	⊙	1	black powder-coated	122 - 300	3.5	1738
44 10 J6	024927	580		1		252 - 400	4.5	1755
44 20 J51	024958	590	⊙ 90°	2	black powder-coated	122 - 300	3.5	1803
44 20 J61	024965	600		2		252 - 400	4.5	1723
44 19 J5	024934	1 pair of spare tips for 44 10 J5						
44 19 J6	024941	1 pair of spare tips for 44 10 J6						
44 29 J51	024972	1 pair of spare tips for 44 20 J51						
44 29 J61	024989	1 pair of spare tips for 44 20 J61						

Circlip Pliers

for large external circlips

- > With locking device, can be released
- > With replaceable tips made of tempered steel
- > Black powder-coated
- > Pliers body: rolled steel, high-strength
- > Tips: special tool steel, oil-hardened

Style 1

- > DIN 5254 A; straight tips

Style 2

- > DIN 5254 B; 90° angled tips



46 10 A5



46 20 A51

Article No.	EAN 4003773-	↔ mm		Style	Pliers	Size of shaft Ø mm	Tips Ø mm	Δ g
46 10 A5	024996	560	⊙	1	black powder-coated	122 - 300	3.5	1773
46 10 A6	025009	570		1		252 - 400	4.5	1795
46 20 A51	025023	570	⊙ 90°	2	black powder-coated	122 - 300	3.5	1832
46 20 A61	025030	580		2		252 - 400	4.5	1826
46 19 A5	024316	1 pair of spare tips for 46 10 A5						
46 19 A6	025016	1 pair of spare tips for 46 10 A6						
46 29 A51	025047	1 pair of spare tips for 46 20 A51						
46 29 A61	025054	1 pair of spare tips for 46 20 A61						

Circlip Tool

for internal and external circlips up to 1,000 mm nominal size

- > Universally usable for large circlips with diameters of 400 - 1000 mm
- > Reliable opening and closing of the circlips and holding by self-locking precision spindle drive
- > For fitting and removing circlips
- > Circlips are reliably caught thanks to short, direct attachment
- > Replaceable tips having working ends with diameters of 6 and 9 mm, for perfect adaption to the handling bores in the circlips
- > Optional operation by hand, with Allen key, ratchet wrench or cordless screwdriver
- > Areas of application are heavy engines where very high forces and torques are transmitted with large shafts and bearings , e.g. wind turbines, tidal power stations, generator construction, hydropower stations, large machine construction (rolling mills, presses), shipbuilding, aerospace
- > Tool in a plastic case with foam insert
- > Tip material: chrome-vanadium electric steel

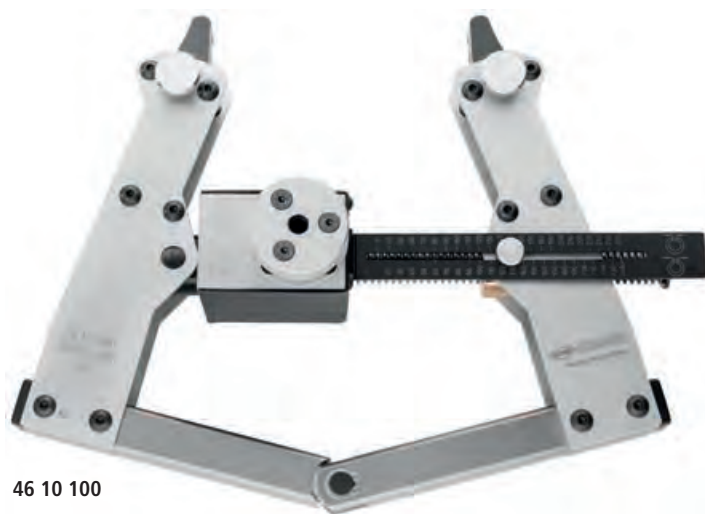

46 10 100



Manually operable



Automated or manual operation

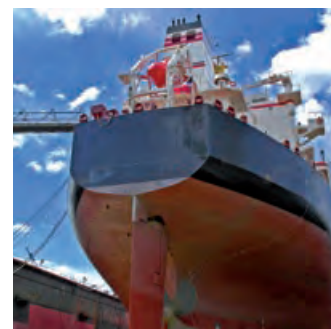

Replaceable inserts for internal and external circlips



Article No.	EAN 4003773-		Size of bore Ø mm	Size of shaft Ø mm	⚖ g
46 10 100	075417	⊙ ⊚	400 - 1000	400 - 1000	2200
46 19 100 01	084549	Spare tips 6 mm			
46 19 100 02	084556	Spare tips 9 mm			

Special Retaining Ring Pliers



for retaining rings on shafts

- > For fitting horseshoe-shaped spring retaining rings and circlips without grip holes
- > For shaft retaining devices
- > With opening spring
- > Chrome vanadium electric steel, forged, oil-hardened

45 10 170

- > For retaining rings with a minimum ring split gap of 3.6 mm

45 21 200

- > Angled jaws with centering hole; for snap rings larger than 12.0 mm dia., e.g. for securing cardan shafts in a motor vehicle; minimum ring split gap of the rings 2.2 mm



45 10 170



45 21 200



45 10 170



45 21 200



45 21 200

Article No.	EAN 4003773-	↔ mm		Pliers	Handles	Δ g
45 10 170	017370	170	MM ○	burnished		156
45 21 200	031208	200	∠30° MM ○	burnished	plastic coated	186

Circlip Pliers

for grip rings on shafts



- > For fitting grip rings on shafts from 1.5 - 30 mm dia.
- > With opening spring
- > Solid style, forged
- > Non-slip, solid tips
- > Pliers body and tips: chrome vanadium steel, forged, oil-hardened

46 11 G0

- > For rings of 1.5 - 4.0 mm dia., with adjustable stop screw to prevent overstretching



46 11 G0



46 11 G1

Article No.	EAN 4003773-	↔ mm		Pliers	Head	Handles	Size of shaft Ø mm	Tips Ø mm	Δ g
46 11 G0	047896	140	MM	black atramentized	polished	plastic coated	1.5 - 4.0	0,9	87
46 11 G1	031062	140	MM	black atramentized	polished	plastic coated	4.0 - 7.0	1,3	85
46 11 G2	031079	140					5.0 - 13.0	1,3	85
46 11 G3	031086	140					14.0 - 18.0	1,3	86
46 11 G4	031093	180					20.0 - 30.0	1,8	134

Set of Circlip Pliers

Compactly packed: four-piece circlip plier sets in practical roll-up bag

- > Tool roll made of hard-wearing polyester fabric
- > With practical, adjustable quick release fastener
- > Dimensions, open (L x H): 315 x 275 mm



00 19 56



00 19 57



00 19 56 V01



00 19 57 V01

Article No.	EAN 4003773- 030973			Style	Capacity Ø mm	Tips Ø mm	Number	g	
00 19 56			Circlip Pliers Set, 4 parts					670	
		⊙	44 11 J2	Circlip Pliers for internal circlips in bore holes	straight tips	19 - 60	1.8	1	
		⊙ ∠90°	44 21 J21		angled tips	19 - 60	1.8	1	
		⊙ /MM	46 11 A2	Circlip Pliers for external circlips on shafts	straight tips	19 - 60	1.8	1	
		⊙ ∠90° /MM	46 21 A21		angled tips	19 - 60	1.8	1	
00 19 56 V01	081548		Circlip Pliers Set, 4 parts					615	
		⊙	44 11 J1	Circlip Pliers for internal circlips in bore holes	straight tips	12 - 25	1.3	1	
		⊙	44 11 J2			19 - 60	1.8	1	
		⊙ /MM	46 11 A1	Circlip Pliers for external circlips on shafts		10 - 25	1.3	1	
		⊙ /MM	46 11 A2			19 - 60	1.8	1	
00 19 57	050056		Precision Circlip Pliers Set, 4 parts					665	
		⊙	48 11 J1	Precision Circlip Pliers for internal circlips in bore holes	straight tips	12 - 25	1.3	1	
		⊙	48 11 J2			19 - 60	1.8	1	
		⊙ /MM	49 11 A1	Precision Circlip Pliers for external circlips on shafts		10 - 25	1.3	1	
		⊙ /MM	49 11 A2			19 - 60	1.8	1	
00 19 57 V01	081555		Precision Circlip Pliers Set, 4 parts					871	
		⊙	48 11 J2	Precision Circlip Pliers for internal circlips in bore holes	straight tips	19 - 60	1.3	1	
		⊙ ∠90°	48 21 J21		bent tips	19 - 60	1.8	1	
		⊙ /MM	49 11 A2	Precision Circlip Pliers for external circlips on shafts	straight tips	19 - 60	1.3	1	
		⊙ ∠90° /MM	49 21 A21		bent tips	19 - 60	1.8	1	
00 19 56 LE	035954		Tool Roll, empty, 4 compartments						171

Set of Circlip Pliers

Handy storage: eight-piece range in space-saving roll-up bag

- > Tool roll made of hard-wearing polyester fabric
- > With practical, adjustable quick release fastener
- > Dimensions, open (L x H): 610 x 240 mm

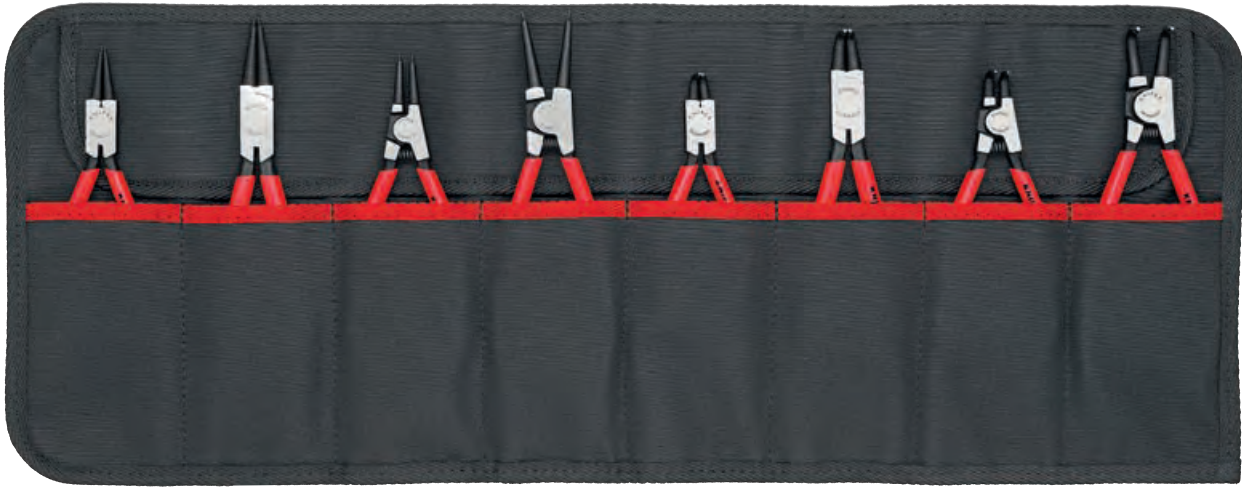

00 19 57 V01



00 19 58 V02

Article No.	EAN		Style	Capacity Ø mm	Tips Ø mm	Number	g
00 19 58 V01	4003773-081562		Circlip Pliers Set, 8 parts				1156
		☉	44 11 J1	straight tips	12 - 25	1.3	1
		☉	44 11 J2		19 - 60	1.8	1
		☉ ∠90°	44 21 J11	angled tips	12 - 25	1.3	1
		☉ ∠90°	44 21 J21		19 - 60	1.8	1
		☉ M	46 11 A1	straight tips	10 - 25	1.3	1
		☉ M	46 11 A2		19 - 60	1.8	1
		☉ ∠90° M	46 21 A11	angled tips	10 - 25	1.3	1
		☉ ∠90° M	46 21 A21		19 - 60	1.8	1
00 19 58 V02	081579		Precision Circlip Pliers Set, 8 parts				1357
		☉	48 11 J1	straight tips	12 - 25	1.3	1
		☉	48 11 J2		19 - 60	1.8	1
		☉ ∠90°	48 21 J11	angled tips	12 - 25	1.3	1
			48 21 J21		19 - 60	1.8	1
		☉ M	49 11 A1	straight tips	10 - 25	1.3	1
			49 11 A2		19 - 60	1.8	1
		☉ ∠90° M	49 21 A11	angled tips	10 - 25	1.3	1
			49 21 A21		19 - 60	1.8	1
00 19 58 LE	081920		Tool Roll, empty, 8 compartments				281

Pliers Sets

Ideally stored and versatile: pliers sets in matching foam insert for workbench and workshop trolley

- > In a foam tray for workbenches and tool trolleys
- > Clearly organised storage of tools
- > Precisely-sized recesses for holding the pliers
- > Foam tray dimensions (W x H x D): 335 x 165 x 33 mm
- > Material: two colour, closed pore foam



00 20 01 V02 Pliers Set "SRZ"



00 20 01 V09 Pliers Set "SRZ II"

Article No.	EAN			Number	g
00 20 01 V02	4003773-069652		Pliers Set "SRZ", six precision circlip pliers in a foam tray		915
		⊙	48 11 J1	1	
		⊙	48 11 J2	1	
		⊙ ∠90°	48 21 J21	1	
		⊙ M	49 11 A1	1	
		⊙ M	49 11 A2	1	
		⊙ M ∠90°	49 21 A21	1	
00 20 01 V09	073291		Pliers Set "SRZ II", four precision circlip pliers in a foam tray		820
		⊙	48 11 J2	1	
		⊙ ∠90°	48 21 J21	1	
		⊙ M	49 11 A2	1	
		⊙ M ∠90°	49 21 A21	1	

Precision Circlip Pliers Set

- > Attractive sales packaging with Euro standard perforation
- > Contains common Precision Circlip Pliers for highest requirements
- > Sturdy plastic packaging, also suitable for storage of the pliers



00 20 03 SB



00 20 04 SB

Article No.	EAN 4003773-			Style	Capacity Ø mm	Tips Ø mm	Quantity	g
00 20 03 SB	050100		Precision Circlip Pliers Set, 4 parts					685
			48 11 J1 Precision Circlip Pliers, for internal circlips in bore holes	straight tips	12 - 25	1.3	1	
			48 11 J2 Precision Circlip Pliers, for internal circlips in bore holes		19 - 60	1.8	1	
			49 11 A1 Precision Circlip Pliers, for external circlips on shafts	straight tips	10 - 25	1.3	1	
			49 11 A2 Precision Circlip Pliers, for external circlips on shafts		19 - 60	1.8	1	
00 20 04 SB	062417		Precision Circlip Pliers Set, 8 parts					1275
			48 11 J1 Precision Circlip Pliers, for internal circlips in bore holes	straight tips	12 - 25	1.3	1	
			48 11 J2 Precision Circlip Pliers, for internal circlips in bore holes		19 - 60	1.8	1	
			49 11 A1 Precision Circlip Pliers, for external circlips on shafts	straight tips	10 - 25	1.3	1	
			49 11 A2 Precision Circlip Pliers, for external circlips on shafts		19 - 60	1.8	1	
			48 21 J11 Precision Circlip Pliers, for internal circlips in bore holes	angled tips	12 - 25	1.3	1	
			48 21 J21 Precision Circlip Pliers, for internal circlips in bore holes		19 - 60	1.8	1	
			49 21 A11 Precision Circlip Pliers, for external circlips on shafts	angled tips	12 - 25	1.3	1	
			49 21 A21 Precision Circlip Pliers, for external circlips on shafts		19 - 60	1.8	1	

Set of Circlip Pliers

- > Attractive sales packaging with Euro standard perforation
- > Contains common Circlip Pliers for internal and external circlips
- > Sturdy plastic packaging, also suitable for storage of the pliers



00 20 03 V02



00 20 04 V01

Article No.	EAN 4003773-			Style	Capacity Ø mm	Tips Ø mm	Quantity	g
00 20 03 V02	077640		Set of Circlip Pliers, 4 parts					450
			44 11 J1 Circlip Pliers, for internal circlips in bore holes	straight tips	12 - 25	1.3	1	
			44 11 J2 Circlip Pliers, for internal circlips in bore holes		19 - 60	1.8	1	
			46 11 A1 Circlip Pliers, for external circlips on shafts	straight tips	10 - 25	1.3	1	
			46 11 A2 Circlip Pliers, for external circlips on shafts		19 - 60	1.8	1	
00 20 04 V01	077633		Set of Circlip Pliers, 8 parts					890
			44 11 J1 Circlip Pliers, for internal circlips in bore holes	straight tips	12 - 25	1.3	1	
			44 11 J2 Circlip Pliers, for internal circlips in bore holes		19 - 60	1.8	1	
			46 11 A1 Circlip Pliers, for external circlips on shafts	straight tips	10 - 25	1.3	1	
			46 11 A2 Circlip Pliers, for external circlips on shafts		19 - 60	1.8	1	
			44 21 J11 Circlip Pliers, for internal circlips in bore holes	angled tips	12 - 25	1.3	1	
			44 21 J21 Circlip Pliers, for internal circlips in bore holes		19 - 60	1.8	1	
			46 21 A11 Circlip Pliers, for external circlips on shafts	angled tips	10 - 25	1.3	1	
			46 21 A21 Circlip Pliers, for external circlips on shafts		19 - 60	1.8	1	

Tool Box "SRZ" Precision Circlip Pliers

Well fixed, safely transported:
Extensive range in handy case

- > High-quality, impact-resistant plastic case
- > Contains common Precision Circlip Pliers for highest requirements
- > Precisely-sized recesses for holding the pliers
- > Clearly organised storage of tools
- > Dimensions, exterior (W x H x D): 260 x 80 x 210 mm



Article No.	EAN			Style	Capacity Ø mm	Tips Ø mm	Number	⚖ g
00 21 25	4003773-050131		Tool Box "SRZ", Precision Circlip Pliers, 8 parts					1635
		○	48 11 J1 48 11 J2	straight tips	12 - 25	1.3	1	
			Precision Circlip Pliers for internal circlips in bore holes		19 - 60	1.8	1	
		○ MM	49 11 A1 49 11 A2		10 - 25	1.3	1	
			Precision Circlip Pliers for external circlips on shafts		19 - 60	1.8	1	
		○ ∠90°	48 21 J11 48 21 J21	angled tips	12 - 25	1.3	1	
			Precision Circlip Pliers for external circlips on shafts		19 - 60	1.8	1	
		○ MM ∠90°	49 21 A11 49 21 A21		10 - 25	1.3	1	
			Precision Circlip Pliers for external circlips on shafts		19 - 60	1.8	1	



Carpenters' Pincers and Concreters' Nippers

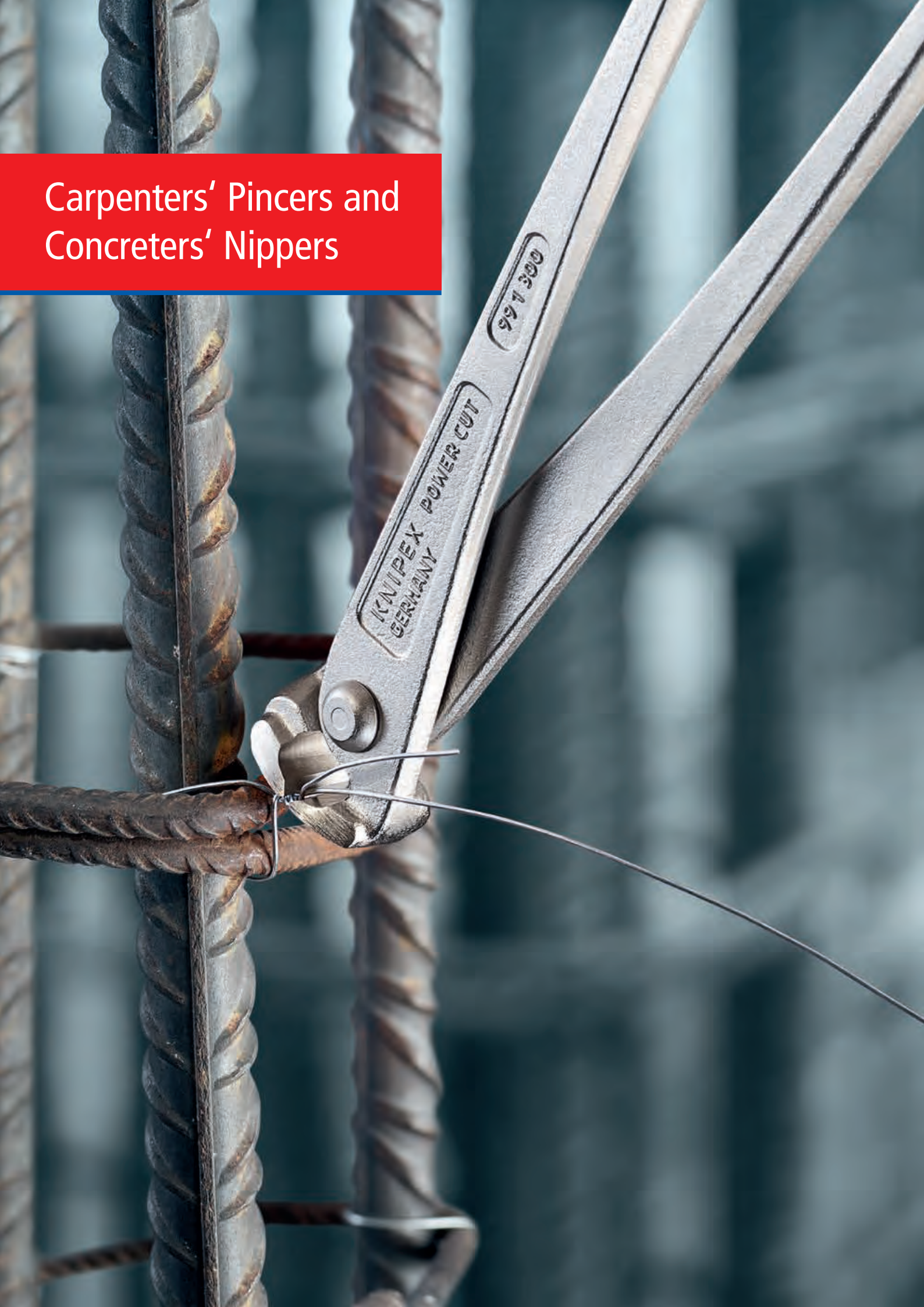

Carpenters' Pincers	74
Hammerhead Style Carpenters' Pincers	74
Farriers' Pincers (Tear-off Pliers for vehicle bodywork)	75
Potters' Pincers (Brick Pincers)	75
End Cutting Nippers	75
Concreters' Nippers (Tower Pincers, Steel Fixers' Nippers)	76
High Leverage Concreters' Nippers	77



Carpenters' Pincers

- > For heavy duty
- > Specially favoured by craftsmen for their precise workmanship
- > Extreme wear resistance and well balanced
- > Cutting edge hardness approx. 60 HRC
- > Special tool steel, forged, oil-hardened
- > DIN ISO 9243



50 00 160



50 00 210



50 00 160

Article No.	EAN 4003773-	↔ mm	Pliers	Head	Handles	Cutting capacities	
						Ø mm	⚖ g
50 00 160	023111	160	black atramentized	polished		1.8	225
50 00 180	021940	180				2.0	320
50 00 210	021957	210				2.2	425
50 00 225	021964	225				2.2	440
50 00 250	022930	250				2.2	570
50 00 300	039662	300				2.4	862
50 01 160	035275	160	black atramentized	polished	plastic coated	1.8	235
50 01 180	035282	180				2.0	330
50 01 210	035299	210				2.2	445
50 01 225	035305	225				2.2	465
50 01 250	035312	250				2.2	595
50 01 300	016915	300				2.4	903

Hammerhead Style Carpenters' Pincers

- > With striking face to hammer down nails
- > Cutting edge hardness approx. 60 HRC
- > Special tool steel, forged, oil-hardened
- > DIN ISO 9243



51 01 210



Multi-functional: driving in and pulling nails

Article No.	EAN 4003773-	↔ mm	Pliers	Head	Handles	Cutting capacities	
						Ø mm	⚖ g
51 01 210	023104	210	black atramentized	polished	plastic coated	2.2	413

Farriers' Pincers

Tear-off Pliers for vehicle bodywork

- > The ideal pliers for the farrier
- > With small head and anvil for redirecting horseshoe-nails
- > Also suitable for dismantling work in vehicle body workshops
- > Cutting edges additionally hardened; cutting edge hardness approx. 59 HRC
- > Special tool steel, forged, multi stage oil-hardened



55 00 300

Article No.	EAN	↔ mm		Pliers	Head	Head width mm	⚖ g
55 00 300	4003773-039402	300		black atramentized	polished	20	780

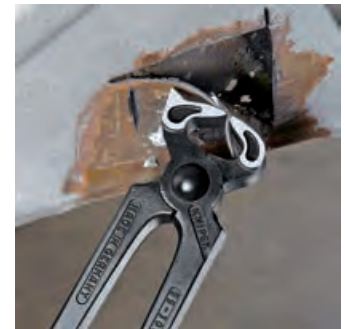

Potters' Pincers

Brick Pincers

- > For pottery work
- > With wire cutter for soft wire
- > Cutting edges additionally hardened; cutting edge hardness approx. 59 HRC
- > Special tool steel, forged, multi stage oil-hardened



58 30 225

Article No.	EAN	↔ mm		Pliers	Head	Head width mm	⚖ g
58 30 225	4003773-014331	225		black atramentized	polished	20	347

End Cutting Nippers

- ▶ The head shape provides optimised movement when tightening steel mesh knots during reinforced concrete work

- > With cutting edges for soft and hard wire
- > Also suitable for twisting and cutting binding wire
- > Cutting edges additionally hardened; cutting edge hardness approx. 61 HRC
- > High-grade special tool steel, forged, multi stage oil-hardened



68 01 280



Article No.	EAN	↔ mm		Pliers	Head	Handles	Cutting capacities			⚖ g
							⊘ mm	⊘ mm	⊘ mm	
68 01 160	013792	160		black atramentized	polished	plastic coated	4.0	2.8	2.3	202
68 01 180	013808	180					4.0	3.2	2.5	284
68 01 200	013815	200					4.0	3.5	2.8	319
68 01 280	077664	280					4.5	4.0	3.2	465

Concreters' Nippers

Tower Pincers, Steel Fixers' Nippers

- > To twist and cut wire in one operation: fast, reliable and economical
- > Cutting edges additionally hardened; cutting edge hardness approx. 61 HRC
- > High-grade special tool steel, forged, multi stage oil-hardened
- > DIN ISO 9242

99 00 220 K12

- > With 12 mm head, particularly suitable for tile paving work



99 00 280



99 00 220 K12



99 01 220



99 04 280



Article No.	EAN 4003773-	↔ mm		Pliers	Head	Handles	Cutting capacities		
							● Ø mm	● Ø mm	⚖ g
99 00 200	014393	200					1.8	1.4	230
99 00 220	013273	220					2.4	1.6	315
99 00 250	013280	250	✔✔	black atramentized	polished		2.4	1.6	405
99 00 280	014096	280					2.8	1.8	455
99 00 300	014409	300					3.1	1.8	510
99 00 220 K12	027812	220	✔✔	black atramentized	polished		2.4	1.6	315
99 01 200	021452	200					1.8	1.4	247
99 01 220	021469	220					2.4	1.6	334
99 01 250	021483	250	✔✔	black atramentized	polished	plastic coated	2.4	1.6	429
99 01 280	021490	280					2.8	1.8	480
99 01 300	014416	300					3.1	1.8	548
99 04 220	048398	220					2.4	1.6	315
99 04 250	048213	250	✔✔	bright zinc plated			2.4	1.6	405
99 04 280	048220	280					2.8	1.8	455

High Leverage Concreters' Nippers

high lever transmission

- ▶ 25 % less effort required compared to conventional concreters' nippers of the same size
- ▶ Extra-slim form for tying deep mounted steel rods
- > To lace concrete reinforcing steel with binding wire from a roll
- > Wire is twisted and cut in a single pass
- > High-leverage joint, minimising strain, even when thick binding wires are used
- > The high damping of the cutting stroke on cutting through the binding wire reduces the strain on tendons and muscles
- > Cutting edges additionally hardened; cutting edge hardness approx. 61 HRC
- > High-grade special tool steel, forged, multi stage oil-hardened
- > DIN ISO 9242



99 10 250



99 11 250



99 14 250



Article No.	EAN 4003773-	↔ mm	Pliers	Head	Handles	Cutting capacities		Head width Ø mm	Δ g
						● Ø mm	● Ø mm		
99 10 250	071396	250	black atramentized	polished		3.3	1.8	25	350
99 10 300	022398	300	black atramentized	polished		3.8	2.0	25	501
99 11 250	071402	250	black atramentized	polished	plastic coated	3.3	1.8	25	350
99 11 300	042365	300	black atramentized	polished	plastic coated	3.8	2.0	25	537
99 14 250	071419	250	bright zinc plated			3.3	1.8	25	350
99 14 300	028116	300	bright zinc plated			3.8	2.0	25	505

Cutting Pliers



Diagonal Cutters for plastics	80
High Leverage Flush Cutter	81
Diagonal Cutter for fibre optics	81
Diagonal Cutters	84
Diagonal Cutters for electromechanics	86
KNIPEX X-Cut® – Compact Diagonal Cutters	87
High Leverage Diagonal Cutters	88
KNIPEX TwinForce® – High Performance Diagonal Cutters	90
High Leverage Centre Cutters	91
KNIPEX CoBolt® S – Compact Bolt Cutters	92
KNIPEX CoBolt® – Compact Bolt Cutters	94
KNIPEX CoBolt® XL – Compact Bolt Cutters	96
Bolt Cutters	97
Concrete Mesh Cutter	98
Bolt End Cutting Nippers	99
High Leverage End Cutting Nippers	99
End Cutting Nippers	101
End Cutting Nippers for mechanics	101



Diagonal Cutters for plastics

- > Cutting face flush
- > For nearly flush cutting of moulded plastic components from sprues
- > Cuts soft materials such as lead in a flush cut
- > With opening spring
- > Vanadium electric steel; forged, oil-hardened



72 01 160



72 02 125



72 11 160



72 21 160

Article No.	EAN	↔ mm		Head	Handles	♁ g	
72 01 140	043713	140				120	
72 01 160	041245	160	▲ MM	polished	plastic coated	164	
72 01 180	046837	180				193	
72 02 125	044215	125	▲ MM	polished	with multi-component grips	109	
72 11 160	046813	160	▲ ∠45° MM	polished	plastic coated	156	
72 21 160	046820	160	▲ ∠85° MM	polished	plastic coated	165	
72 09 01	053415	Pressure spring for 72 01					

High Leverage Flush Cutter

for soft metal and plastic

- > For the flush cutting of soft materials, e.g. plastic, aluminium, copper, lead
- > Permits the energy-saving cutting of thick work components made of soft metal and plastic
- > 20° angled head with single-sided joint bar and diagonal cutting edge for flush cutting; with space for gripping
- > Opening spring and locking device are integrated in the handles also for comfortable work and protected transport
- > Precision cutting edges for soft material
- > Cutting edges additionally hardened; cutting edge hardness approx. 59 HRC
- > Chrome vanadium electric steel, forged, multi stage oil-hardened



Clean, flush cutting of copper conductor rails



Ideal for the flush cutting plastic sprues with large diameters



72 62 200



Article No.	EAN 4003773- 081913	↔ mm 200	▶▶	Pliers	Handles	Cutting capacities	
						Ø mm	⚖ g
72 62 200	081913	200	▶▶	black atramentized	with slim multi-component grips	6.0	375

Diagonal Cutter for fibre optics

- > Specially developed for cutting fibre optics (glass fibre cables)
- > Cutting face flush
- > Cutting edges additionally induction-hardened, cutting edge hardness approx. 63 HRC
- > With opening spring
- > Vanadium electric steel, forged, multi stage oil-hardened



72 51 160

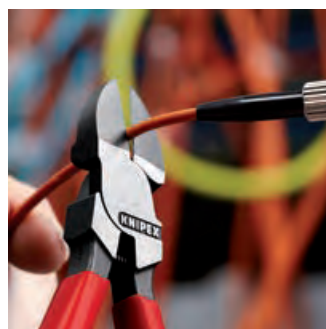

Article No.	EAN 4003773- 028031	↔ mm 160	▶▶	Head	Handles	⚖ g
						166
72 51 160	028031	160	▶▶	polished	plastic coated	166

KNIPEX WORLD OF DIAGONAL CUTTERS

With four tailor-made diagonal cutters, KNIPEX provides solutions for every application. An extraordinary variety ensures an excellent response from the "KNIPEX World of diagonal cutters" to whatsoever specification.

KNIPEX-Diagonal Cutter

The classic model. The indispensable cutting tool for versatile use.

KNIPEX-High Leverage Diagonal Cutter

The robust. For very tough, continuous use.

KNIPEX X-Cut®

The all-rounder. Compact and light. Powerful and precise.

KNIPEX TwinForce®

The superior model. For comfortable cutting, repetitive cutting or extremely hard cutting jobs.

TwinForce®



The reapplying cutter

Double-hinged design

Hand force is multiplied by 39

Diagonal Cutter



Long cutting edges for cutting cable; also precise enough for the finest stranded wires
Hand force is multiplied by 12

High Leverage Diagonal Cutter



Forged on hinged joint for robust use
Hand force is multiplied by 13

X-Cut®



Box joint:
greatest stability with little weight
Hand force is multiplied by 16

16 Kg
with
reapplication*

33 Kg

30 Kg

40 Kg

Required hand
force for a nail
with Ø 3 mm

* notch – reapply – cut through

KNIPEX TwinForce® 180 mm
The reapplying cutter*

High Leverage
Diagonal Cutter 180 mm

KNIPEX X-Cut® 160 mm

Diagonal Cutter 160 mm



Diagonal Cutters

- > The indispensable diagonal cutter for all-round use
- > High-quality material and precise workmanship for long service life
- > Precision cutting edges for soft and hard wire
- > Clean cutting of thin copper wires, also at the cutting edge tips
- > Cutting edges additionally induction-hardened, cutting edge hardness approx. 62 HRC
- > Narrow head style for use in confined areas
- > Vanadium electric steel, forged, multi stage oil-hardened
- > DIN ISO 5749

70 05 160 T / 70 05 180 T / 70 06 160 T / 70 06 180 T*

- > Pliers with tether attachment point for mounting a fall protection



70 01 160

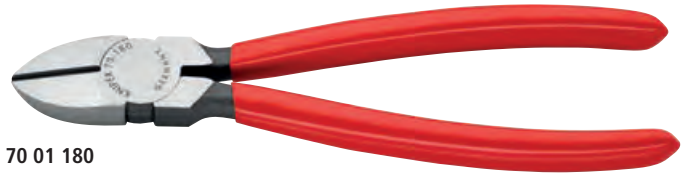

70 01 180



70 02 180



70 05 180



70 05 180 T



70 06 180



70 07 180



70 15 110

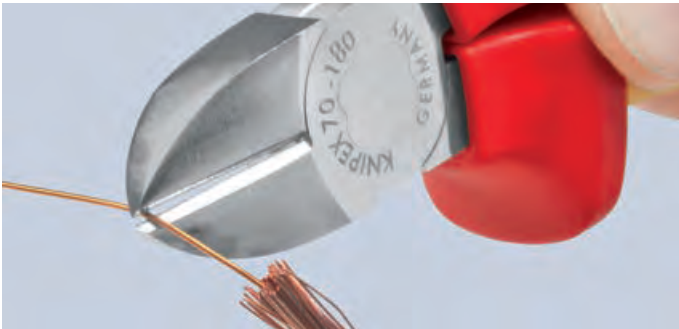

Clean cutting of thin copper wires, also at the cutting edge tips





Article No.	EAN 4003773-	↔ mm		Pliers	Head	Handles	Cutting capacities			
							☉ Ø mm	☽ Ø mm	☾ Ø mm	⚖ g
70 01 110	014324	110					3.0	2.0	1.2	80
70 01 125	013402	125	🟢	black atramentized	polished	plastic coated	3.0	2.3	1.5	80
70 01 140	013419	140					4.0	2.5	1.8	126
70 01 180	018070	180					4.0	3.0	2.5	200
70 01 160	013426	160	🟢	black atramentized	polished	plastic coated	4.0	3.0	2.0	171
70 02 125	034025	125					3.0	2.3	1.5	119
70 02 140	023098	140	🟢	black atramentized	polished	with multi-component grips	4.0	2.5	1.8	150
70 02 180	034049	180					4.0	3.0	2.5	252
70 02 160	034032	160	🟢	black atramentized	polished	with multi-component grips	4.0	3.0	2.0	206
70 05 125	039501	125					3.0	2.3	1.5	119
70 05 140	039488	140	🟢	chrome plated	chrome plated	with multi-component grips	4.0	2.5	1.8	154
70 05 180	043706	180					4.0	3.0	2.5	246
70 05 160	039600	160	🟢	chrome plated	chrome plated	with multi-component grips	4.0	3.0	2.0	207
70 05 180 T	080039	180	🟢	chrome plated	chrome plated	with multi-component grips and integrated tether attachment point	4.0	3.0	2.5	258
70 05 160 T	080022	160	🟢	chrome plated	chrome plated	with multi-component grips and integrated tether attachment point	4.0	3.0	2.0	210
70 06 125	018124	125					3.0	2.3	1.5	121
70 06 140	040293	140	🟢 ⚡ 1000 V ⚠️	chrome plated	chrome plated	insulated with multi-component grips, VDE-tested	4.0	2.5	1.8	160
70 06 180	033813	180					4.0	3.0	2.5	254
70 06 180 T	081470	180	🟢 ⚡ 1000 V ⚠️	chrome plated	chrome plated	insulated with multi-component grips with integrated insulated tether attachment point, VDE tested	4.0	3.0	2.5	270
70 06 160	021995	160	🟢 ⚡ 1000 V ⚠️	chrome plated	chrome plated	insulated with multi-component grips, VDE-tested	4.0	3.0	2.0	216
70 06 160 T	081463	160	🟢 ⚡ 1000 V ⚠️	chrome plated	chrome plated	insulated with multi-component grips with integrated insulated tether attachment point, VDE tested	4.0	3.0	2.0	230
70 07 180	018179	180	🟢 ⚡ 1000 V ⚠️	chrome plated	chrome plated	with dipped insulation, VDE-tested	4.0	3.0	2.5	269
70 07 160	018155	160	🟢 ⚡ 1000 V ⚠️	chrome plated	chrome plated	with dipped insulation, VDE-tested	4.0	3.0	2.0	227
70 11 110	018193	110	🟢 W	black atramentized	polished	plastic coated	3.0	2.0	1.2	91
70 15 110	029649	110	🟢 W	chrome plated	chrome plated	with multi-component grips	3.0	2.0	1.2	98
70 26 160	018223	160	🟡 ⚡ 1000 V ⚠️	chrome plated	chrome plated	insulated with multi-component grips, VDE-tested	4.0			216

Diagonal Cutter

for electromechanics

- > With sharp, precisely aligned cutting edges
- > Cutting edges additionally induction-hardened, cutting edge hardness approx. 63 HRC
- > Lap joint
- > Vanadium electric steel, forged, multi stage oil-hardened
- > DIN ISO 5749

76 12 125

- > Low-friction double spring for gentle and even opening

76 22 125

- > Low-friction double spring for gentle and even opening; without bevel for flush cutting of soft wires

76 81 125

- > Particularly tapered head with small bevel for work in confined areas (cable harnesses, multiple stranded wires)



76 01 125



76 03 125



76 05 125



76 12 125



76 81 125

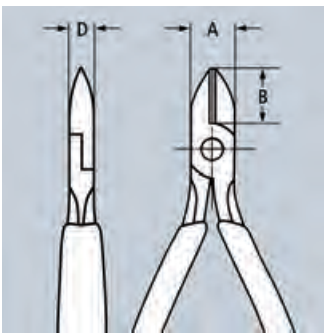

Article No.	EAN 4003773-	↔ mm		Pliers	Head	Handles	Cutting capacities				Dimensions			⚖ g
							◐ Ø mm	◑ Ø mm	◒ Ø mm	● Ø mm	A Ø mm	B Ø mm	D Ø mm	
76 01 125	044482	125		black atramentized	polished	plastic coated	0.4 - 3.0	2.3	1.5	0.6	14.5	16.0	9.0	85
76 03 125	048923	125		chrome plated	chrome plated	plastic coated	0.4 - 3.0	2.3	1.5	0.6	14.5	16.0	9.0	85
76 05 125	005315	125		chrome plated	chrome plated	with multi-component grips	0.4 - 3.0	2.3	1.5	0.6	14.5	16.0	9.0	118
76 12 125	048015	125		black atramentized	polished	with multi-component grips	0.4 - 3.0	2.3	1.5	0.6	14.5	16.0	9.0	112
76 22 125	048022	125		black atramentized	polished	with multi-component grips	0.4 - 2.5				14.5	16.0	9.0	107
76 81 125	040644	125		black atramentized	polished	plastic coated	0.4 - 1.7	1.3	0.8		14.5	16.0	9.0	85

KNIPEX X-Cut®

Compact Diagonal Cutters high lever transmission

- ▶ Cuts finest strands as well as multi-core cables and piano wires
- ▶ Powerful, light and universal
- > High cutting performance with minimum effort due to optimum co-ordination of the cutting edge angle and transmission ratio
- > Box-joint design: highest stability with low weight
- > Doubly supported joint axis for heavy duty
- > Large opening width for thicker cables
- > Cuts precisely, even through fine copper wires
- > Compact, low-weight construction
- > Universally usable, in the assembly, maintenance and production
- > Chrome vanadium heavy-duty steel, forged, multi stage oil-hardened
- > Precision cutting edges additionally induction-hardened, cutting edge hardness approx. 62 HRC
- > DIN ISO 5749

73 05 160 T / 73 06 160 T*

- > Pliers with tether attachment point for mounting a fall protection



73 02 160



73 05 160



73 05 160 T



73 06 160

40 % less effort
required compared to diagonal cutters of the same length.
With double mounted hinged joint.

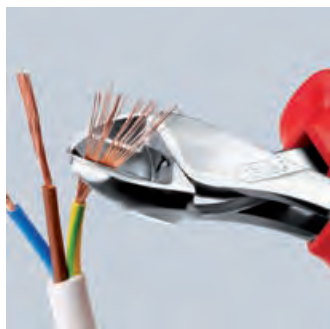

Box-joint design: highest stability with low weight

Article No.	EAN 4003773-	↔ mm	Icons	Pliers	Head	Handles	Cutting capacities					g
							Ø mm	Ø mm	Ø mm	Ø mm	Ø mm	
73 02 160	075127	160	✂	black atramentized	polished	with multi-component grips	4.8	3.8	2.7	2.2	12.0	175
73 05 160	075134	160	✂	chrome plated	chrome plated	with multi-component grips	4.8	3.8	2.7	2.2	12.0	175
73 05 160 T	080077	160	✂	chrome plated	chrome plated	with multi-component grips and integrated tether attachment point	4.8	3.8	2.7	2.2	12.0	180
73 06 160	075141	160	✂ ⚡ 1000V	chrome plated	chrome plated	insulated with multi-component grips, VDE-tested	4.8	3.8	2.7	2.2	12.0	175
73 06 160 T	081487	160	✂ ⚡ 1000V	chrome plated	chrome plated	insulated with multi-component grips with integrated insulated tether attachment point, VDE tested	4.8	3.8	2.7	2.2	12.0	185

*Other tools with tethering can be found from page 266

High Leverage Diagonal Cutters

- > For very tough, continuous use
- > High cutting performance with minimum effort due to optimum co-ordination of the cutting edge angle and transmission ratio
- > Precision cutting edges additionally induction-hardened (cutting edge hardness approx. 64 HRC), for all sorts of wire including piano wire
- > Chrome vanadium heavy-duty steel, forged, multi stage oil-hardened
- > DIN ISO 5749

Style 1

- > With opening spring; to be activated if required

Style 2

- > 12° angled head offers clearance for gripping

Length 250 mm

- > The 250-mm-long diagonal cutter is suitable for copper conductors up to 16 mm² and aluminium conductors up to 35 mm²

74 02 200 / 74 02 250 / 74 06 250 T / 74 22 200 / 74 22 250 T*

- > Pliers with tether attachment point for mounting a fall protection



74 01 200

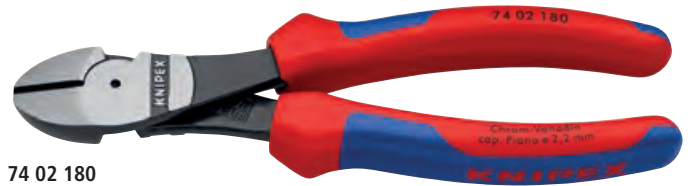

74 02 180



74 02 200 T

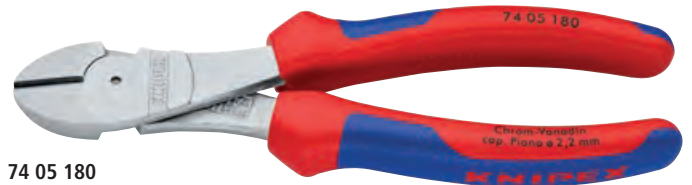

74 05 180



74 06 200



74 06 200 T



74 07 200



74 12 180

20% less effort

required compared to high-leverage diagonal cutters of the same length. With integrated forged joint axle.



74 12: just gentle sliding with your thumb will activate the opening spring



74 12: opening spring in deactivated position





With integrated forged axle for heavy duty

Article No.	EAN 4003773-	↔ mm		Style	Pliers	Head	Handles	Cutting capacities			⚖ g
								◐ Ø mm	◑ Ø mm	● Ø mm	
74 01 140	039747	140		0				3.1	2.0	1.5	131
74 01 160	033141	160		0				3.4	2.5	2.0	178
74 01 180	022008	180	✂	0	black atramentized	polished	plastic coated	3.8	2.7	2.2	241
74 01 200	034056	200		0				4.2	3.0	2.5	263
74 01 250	034063	250		0				4.6	3.5	3.0	391
74 02 140	042419	140		0				3.1	2.0	1.5	157
74 02 160	023081	160		0				3.4	2.5	2.0	209
74 02 180	023074	180	✂	0	black atramentized	polished	with multi-component grips	3.8	2.7	2.2	273
74 02 200	040309	200		0				4.2	3.0	2.5	304
74 02 250	042402	250		0				4.6	3.5	3.0	437
74 02 200 T	080084	200		0	black atramentized	polished	with multi-component grips and integrated tether attachment point	4.2	3.0	2.5	305
74 02 250 T	080091	250	✂	0				4.6	3.5	3.0	460
74 05 140	039617	140		0				3.1	2.0	1.5	157
74 05 160	022961	160		0				3.4	2.5	2.0	209
74 05 180	022978	180	✂	0	chrome plated	chrome plated	with multi-component grips	3.8	2.7	2.2	270
74 05 200	035367	200		0				4.2	3.0	2.5	303
74 05 250	039754	250		0				4.6	3.5	3.0	440
74 06 160	040705	160		0				3.4	2.5	2.0	215
74 06 180	022985	180	✂ ⚡ 1000 V	0	chrome plated	chrome plated	insulated with multi-component grips, VDE-tested	3.8	2.7	2.2	280
74 06 200	033820	200	⚡ 1000 V	0				4.2	3.0	2.5	304
74 06 250	041955	250		0				4.6	3.5	3.0	453
74 06 200 T	081494	200	✂ ⚡ 1000 V	0	chrome plated	chrome plated	insulated with multi-component grips with integrated insulated tether attachment point, VDE tested	4.2	3.0	2.5	305
74 06 250 T	081500	250	⚡ 1000 V	0				4.6	3.5	3.0	465
74 07 200	018414	200	✂ ⚡ 1000 V	0	chrome plated	chrome plated	with dipped insulation, VDE-tested	4.2	3.0	2.5	328
74 07 250	018421	250	⚡ 1000 V	0				4.6	3.5	3.0	510
74 12 160	065111	160	✂ MM	1	black atramentized	polished	with multi-component grips	3.4	2.5	2.0	209
74 12 180	060192	180		1				3.8	2.7	2.2	273
74 21 180	069973	180		2				3.8	2.7	2.2	235
74 21 200	050483	200	✂ ∠12°	2	black atramentized	polished	plastic coated	4.2	3.0	2.5	258
74 21 250	045021	250		2				4.6	3.5	3.0	390
74 22 200	051831	200		2	black atramentized	polished	with multi-component grips	4.2	3.0	2.5	300
74 22 250	071372	250	✂ ∠12°	2				4.6	3.5	3.0	437
74 22 200 T	080107	200		2	black atramentized	polished	with multi-component grips and integrated tether attachment point	4.2	3.0	2.5	305
74 22 250 T	080114	250	✂ ∠12°	2				4.6	3.5	3.0	460

KNIPEX TwinForce®

High Performance Diagonal Cutters

► The superior High-Leverage Diagonal Cutter with patented double joint

- > Ideal transmission of force due to double-hinged design
- > Reliably cuts all types of wire, including steel tape
- > For rough or very fine cutting
- > Low cutting impact: gentle on hands. The tension on muscles and tendons is relieved
- > For comfortable cutting, repetitive cutting or extremely hard cutting jobs
- > High degree of stability and zero-backlash due to precisely milled forged-in axles
- > Chrome vanadium heavy-duty steel, forged, multi stage oil-hardened
- > Precision cutting edges additionally induction-hardened, cutting edge hardness approx. 63 – 64,5 HRC
- > DIN ISO 5749

73 72 180 F

> With opening spring to simplify reapplication and for repetitive cutting



73 71 180



73 72 180



73 72 180 F



The high performance diagonal cutters with opening spring for easier reapplication and for heavy use



The opening spring can be easily activated and deactivated by a press of the thumb

Cuts again 50% easier than the tried and tested KNIPEX high leverage diagonal cutters

The option to reapply the tool. The KNIPEX TwinForce® cuts even 4 mm thick wire without great effort when reapplied two or three times.

Conventional high leverage diagonal cutters either cannot cut these diameters or only with very great effort.

KNIPEX TwinForce® Reapplying

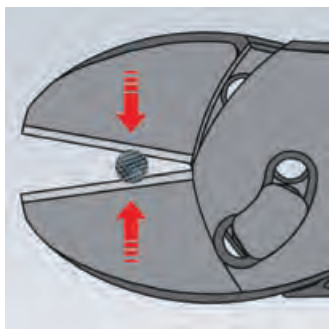

Insert the wires as close to the hinge as possible. In case of cutters with very high transmission, the width of the gap between the cutting edges close to the fulcrum may be less than the thickness of the wire. Wires may slip forward when the cutting starts.

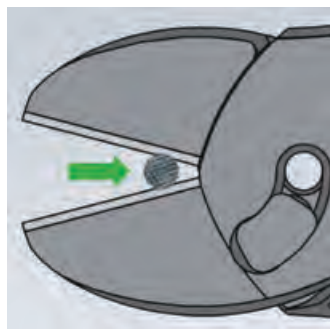

First make a notch in the wire using the KNIPEX TwinForce® until the required hand force increases considerably. Now open the pliers and slide the wire backwards towards the joint. Hold the cutting edge in the notches you have made in step 1.

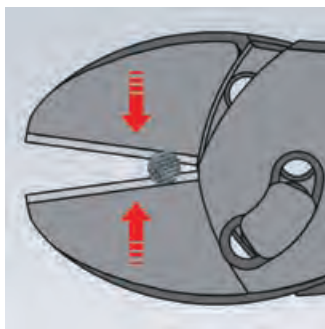

Continue cutting in the same location along the wire. Now cutting is much more easier because the wire remains in place closer to the fulcrum.

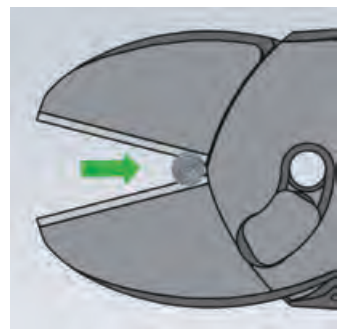

You can repeat this process if necessary.

Article No.	EAN 4003773-	↔ mm	PATENTED	Pliers	Head	Handles	Cutting capacities				g
							Ø mm	Ø mm	Ø mm	Ø mm	
73 71 180	074762	180	PATENTED	black atramentized	polished	plastic coated	5.5	4.6	3.2	3.0	255
73 72 180	074779	180	PATENTED	black atramentized	polished	with multi-component grips	5.5	4.6	3.2	3.0	280
73 72 180 F	077657	180	PATENTED	black atramentized	polished	with multi-component grips	5.5	4.6	3.2	3.0	280



High Leverage Centre Cutters

- > With integrated forged axle for heavy duty
- > With precision cutting edges for soft, hard and piano wire
- > Cuts thick wires with less effort than other diagonal cutters of the same length
- > Centric precision cutting edges
- > High cutting performance with minimum effort due to optimum co-ordination of the cutting edge angle and transmission ratio
- > Cutting edges additionally induction-hardened, cutting edge hardness approx. 64 HRC
- > Chrome vanadium heavy-duty steel, forged, multi stage oil-hardened



74 91 250



The cutting edges are in the centre of the cutter head



Article No.	EAN	↔ mm	Pliers	Head	Handles	Cutting capacities				⚖ g
						Ø mm	Ø mm	Ø mm	Ø mm	
74 91 250	4003773-034070	250	black atramentized	polished	plastic coated	5.0	5.0	3.8	3.5	395



KNIPEX CoBolt® S

Compact and powerful

In a handy length of 160 mm

KNIPEX CoBolt® S

Compact Bolt Cutters

► Specially suitable for small hands

- > Precision cutting edges for soft and hard wire as well as piano wire
- > Cuts components such as bolts, nails, rivets etc. up to Ø 4.4 mm
- > Extremely high cutting capacity with little effort required due to extremely effective joint design
- > Cutting edges additionally induction-hardened, cutting edge hardness approx. 64 HRC
- > The microstructure on cutters keeps the material to be cut in a good insertion position: makes optimal use of the mechanics
- > With gripping surface below the joint for gripping and pulling wires from Ø 1.0 mm
- > Chrome vanadium heavy-duty steel, forged, multi stage oil-hardened



71 01 160



71 31 160



Powerful through to the tips



Slim head for ideal accessibility



Compact, light and always to hand

Article No.	EAN	↔ mm	Pliers	Handles	Cutting capacities				⚖ g	
					⊘ mm	⊘ mm	⊘ mm	⊘ mm		
71 01 160	082668	160	✂	black atramentized	plastic coated	5.3	4.4	3.2	3.0	200
71 31 160	084587	160	✂	black atramentized	plastic coated	5.3	4.4	3.2	3.0	200

KNIPEX CoBolt®

Compact Bolt Cutters

Clever muscle man

- > With precision cutting edges for soft, hard and piano wire
- > Cuts bolts, nails, rivets, etc. up to 5.2 mm dia.
- > Efficient joint design ensures exceptional cutting performance with little effort
- > Cutting edges additionally induction-hardened, cutting edge hardness approx. 64 HRC
- > Chrome vanadium heavy-duty steel, forged, multi stage oil-hardened
- > DIN ISO 5743

- ▶ Micro-structured cutting edge reduces slipping of the material from the jaws
- ▶ With gripping surface below the joint for gripping and pulling wires with a diameter as from 1 mm

71 12 200

opening spring and locking device are integrated in the handles also for comfortable work and protected transport

71 02 200 T*

Pliers with tether attachment point for mounting a fall protection



Micro-structured cutting edge allows easy cutting of large cross-sections



With gripping surface below the joint for gripping and pulling wires with a diameter as from 1 mm



Opening spring and locking device are integrated in the handles also for comfortable work and protected transport

CoBolt®

60% less effort

required compared to conventional high-leverage diagonal cutters. The ingenious lever-action mechanism ensures an extremely favourable lever ratio with very little friction. The cutting force is about 30 times higher than the hand force applied.



71 01 200



71 02 200



71 02 200 T



71 12 200

Article No.	EAN 4003773-	↔ mm	Pliers	Handles	Cutting capacities				⚖ g
					◐ Ø mm	◑ Ø mm	◒ Ø mm	● Ø mm	
71 01 200	033165	200	black atramentized	plastic coated	6.0	5.2	4.0	3.6	335
71 02 200	047056	200		with slim multi-component grips	6.0	5.2	4.0	3.6	372
71 02 200 T	080046	200	black atramentized	with multi-component grips and integrated tether attachment point	6.0	5.2	4.0	3.6	376
71 12 200	066859	200	black atramentized	with slim multi-component grips	6.0	5.2	4.0	3.6	375

- ▶ The recess in the blade allows easier cutting of thicker wires, e.g. for anchor bolts in false ceilings
- ▶ With gripping surface below the joint for gripping and pulling wires with a diameter as from 1 mm

71 32 200 / 71 32 200 T*

opening spring and locking device are integrated in the handles also for comfortable work and protected transport

71 32 200 T*

Pliers with tether attachment point for mounting a fall protection



71 32 200



71 31 200/71 32 200/71 32 200 T
The recess in the blade allows easier cutting of thicker wires, e.g. for anchor bolts in false ceilings



71 31 200/71 32 200/71 32 200 T
With gripping surface below the joint for gripping and pulling wires with a diameter as from 1 mm



Article No.	EAN 4003773-	↔ mm	Style	Pliers	Handles	Cutting capacities				g
						Ø mm	Ø mm	Ø mm	Ø mm	
71 31 200	042327	200	3	black atramentized	plastic coated	6.0	5.2	4.0	3.6	330
71 32 200	066880	200	3	black atramentized	with slim multi-component grips	6.0	5.2	4.0	3.6	370
71 32 200 T	080060	200			with multi-component grips and integrated tether attachment point	6.0	5.2	4.0	3.6	374

- ▶ 20° angled head with single-sided joint bar and diagonal cutting edge for flush cutting; with space for gripping

71 22 200 / 71 22 200 T*

opening spring and locking device are integrated in the handles also for comfortable work and protected transport

71 22 200 T*

Pliers with tether attachment point for mounting a fall protection

71 41 200

the recess in the blade allows easier cutting of thicker wires, e.g. for anchor bolts in false ceilings



71 21 200



71 22 200

Article No.	EAN 4003773-	↔ mm	Style	Pliers	Handles	Cutting capacities				g
						Ø mm	Ø mm	Ø mm	Ø mm	
71 21 200	066866	200	∠20°	black atramentized	plastic coated	6.0	5.2	4.0	3.6	320
71 22 200	066873	200	∠20°	black atramentized	with slim multi-component grips	6.0	5.2	4.0	3.6	375
71 22 200 T	080053	200			with multi-component grips and integrated tether attachment point	6.0	5.2	4.0	3.6	379
71 41 200	066897	200	∠20°	black atramentized	plastic coated	6.0	5.2	4.0	3.6	335

*Other tools with tethering can be found from page 266

KNIPEX CoBolt® XL

Compact Bolt Cutters

The compact bolt cutters from KNIPEX now also available with long handles for one and two-hand operation. Up to a 40-fold increase of manual force.

- ▶ For powerful cutting of larger cross-sections as well as very hard materials
- ▶ Two-hand operation for maximum cutting force
- > 60 % less effort required compared to conventional high-leverage diagonal cutters
- > 40-fold increase of manual force due to special joint design
- > With gripping surface below the joint for gripping and pulling wires from Ø 1.0 mm
- > Induction-hardened precision blades: cutting edge hardness approx. 64 HRC
- > Chrome vanadium heavy-duty steel, forged, multi stage oil-hardened

71 01 250

- > Straight cutting edges

71 31 250

- > Blades with recess for easier cutting of larger cross-sections thanks to better leverage close to the fulcrum



71 01 250



71 31 250



Two-hand operation for maximum cutting force

Article No.	EAN 4003773-	↔ mm	✚	Pliers	Handles	Cutting capacities			⚖ g
						● Ø mm	● Ø mm	● Ø mm	
71 01 250	079637	250	✚	black atramentized	plastic coated	5.6	4.0	3.8	465
71 31 250	079644	250	✚	black atramentized	plastic coated	6.0	4.3	4.2	475



Bolt Cutters

Cuts hard components up to 48 HRC

- > Cutting capacity up to 48 HRC hardness
- > Robust cutting edges are additionally induction-hardened, cutting edge hardness approx. 62 HRC
- > Forged-in stopper with comfortable shock-absorber
- > Good access due to very flat construction of head and joint area
- > Ergonomically angled handles to minimise effort
- > Sturdy non-slip two-colour dual component handle sleeves
- > Precise adjustment (12 positions) by eccentric bolt
- > High cutting performance with minimum effort due to optimum co-ordination of the cutting edge angle and transmission ratio
- > Bolted cutter head, replaceable
- > Joint: special tool steel, forged
- > Handles: steel tube, powder-coated
- > Blade: chrome vanadium heavy-duty steel, forged, multi stage oil-hardened



Forged-in stopper with damping inserts: cushions the cutting stroke comfortably



71 72 460 71 72 610 71 72 760 71 72 910



Article No.	EAN 4003773-	↔ mm	Head	Handles	Cutting capacities			Δ g
					HRC 19 Ø mm	HRC 40 Ø mm	HRC 48 Ø mm	
71 72 460	066750	460	grey atramentized	with multi-component grips	8.0	6.0	5.0	2100
71 72 610	066767	610			9.0	8.0	7.0	2550
71 72 760	066774	760			11.0	9.0	8.0	4250
71 72 910	066781	910			13.0	10.0	9.0	4950
71 79 460	066804	Spare cutter head for 71 72 460 complete with screws						
71 79 610	066811	Spare cutter head for 71 72 610 complete with screws						
71 79 760	066828	Spare cutter head for 71 72 760 complete with screws						
71 79 910	066835	Spare cutter head for 71 72 910 complete with screws						

Concrete Mesh Cutter

- > Cutting capacity up to 48 HRC hardness
- > Robust cutting edges are additionally induction-hardened, cutting edge hardness approx. 62 HRC
- > Forged-in stopper with comfortable shock-absorber
- > Good access due to very flat construction of head and joint area
- > Ergonomically angled handles to minimise effort
- > Sturdy non-slip two-colour dual component handle sleeves
- > Precise adjustment (12 positions) by eccentric bolt
- > High cutting performance with minimum effort due to optimum co-ordination of the cutting edge angle and transmission ratio
- > Bolted cutter head, replaceable
- > Joint: special tool steel, forged
- > Handles: steel tube, powder-coated
- > Blade: chrome vanadium heavy-duty steel, forged, multi stage oil-hardened



The special shape of the mesh cutter head, 71 82 950, enables it to cut structural steel that is lying down flat



71 82 950



Article No.	EAN 4003773- 066798	↔ mm 950	Head grey atramentized	Handles with multi-component grips	Cutting capacities			⚖ g 4110
					HRC 19 Ø mm 11.0	HRC 40 Ø mm 9.0	HRC 48 Ø mm 6.0	
71 82 950								
71 89 950	066842	Spare cutter head for 71 82 950 complete with screws						

Bolt End Cutting Nippers

high lever transmission

► Powerful, compact, comfortable

- > Better handling, geater capacity and lower handforce required compared to conventional bolt end cutting nippers
- > With cutting edges for soft, hard and piano wire
- > Particularly high cutting capacity with minimum effort due to optimum transmission ratio
- > Cutting edges additionally induction-hardened, cutting edge hardness approx. 64 HRC
- > Handles angled for better accessibility
- > Vanadium electric steel, forged, multi stage oil-hardened

61 02 200

- > With slim multi-component grips without collar for better handling and easier transport; with large contact surface on the handles for better allotment of pressure and more comfort at work



61 01 200



61 02 200



Extraordinary cutting performance: also for piano wire



Particularly efficient for fence construction



Almost flush cutting of bolts, nails etc.

Article No.	EAN 4003773-	↔ mm	Pliers	Head	Handles	Cutting capacities				⚖ g
						Ø mm	Ø mm	Ø mm	Ø mm	
61 01 200	033172	200	black atramentized	polished	plastic coated	1.0 - 6.0	4.0	3.5	3.0	435
61 02 200	067047	200	black atramentized	polished	with slim multi-component grips	1.0 - 6.0	4.0	3.5	3.0	435

High Leverage End Cutting Nippers

- > With cutting edges for soft, hard and piano wire
- > High cutting capacity with little effort due to optimum co-ordination of cutting edge angle and transmission ratio
- > Cutting edges additionally induction-hardened, cutting edge hardness approx. 64 HRC
- > Chrome vanadium heavy-duty steel, forged, multi stage oil-hardened
- > DIN ISO 5748



67 01 200



67 05 200

Article No.	EAN 4003773-	↔ mm	Pliers	Head	Handles	Cutting capacities				⚖ g
						Ø mm	Ø mm	Ø mm	Ø mm	
67 01 140	043690	140				4.0	3.1	2.0	1.5	152
67 01 160	040620	160	black atramentized	polished	plastic coated	4.5	3.4	2.5	2.0	237
67 01 200	040637	200				5.0	3.8	3.0	2.5	318
67 05 140	017929	140				4.0	3.1	2.0	1.5	176
67 05 160	017936	160	chrome plated	chrome plated	with multi-component grips	4.5	3.4	2.5	2.0	266
67 05 200	017943	200				5.0	3.8	3.0	2.5	361



End Cutting Nippers

► The head shape provides optimised movement when tightening steel mesh knots during reinforced concrete work

- > With cutting edges for soft and hard wire
- > Also suitable for twisting and cutting binding wire
- > Cutting edges additionally hardened; cutting edge hardness approx. 61 HRC
- > High-grade special tool steel, forged, multi stage oil-hardened
- > DIN ISO 5748



68 01 180



68 01 280

Article No.	EAN 4003773-	↔ mm		Pliers	Head	Handles	Cutting capacities			
							☉ Ø mm	☽ Ø mm	◐ Ø mm	⚖ g
68 01 160	013792	160					4.0	2.8	2.3	202
68 01 180	013808	180	🟢	black atramentized	polished	plastic coated	4.0	3.2	2.5	284
68 01 200	013815	200					4.0	3.5	2.8	319
68 01 280	077664	280	🟢	black atramentized	polished	plastic coated	4.5	4.0	3.2	465

End Cutting Nippers

for mechanics

- > With cutting edges for soft, hard and piano wire; also suitable for thin copper wires
- > Lap joint
- > Cutting edges additionally induction-hardened, cutting edge hardness approx. 64 HRC
- > Chrome vanadium heavy-duty steel, forged, multi stage oil-hardened
- > DIN ISO 5748

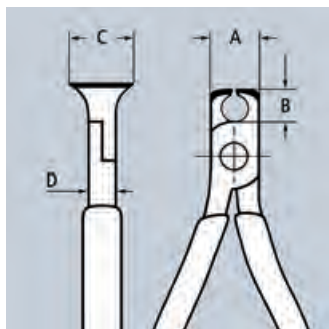

69 01 130



69 03 130

Article No.	EAN 4003773-	↔ mm		Pliers	Head	Handles	Cutting capacities				Dimensions				
							☉ Ø mm	☽ Ø mm	◐ Ø mm	● Ø mm	A Ø mm	B Ø mm	D Ø mm	C Ø mm	⚖ g
69 01 130	017974	130	🟢	black atramentized	polished	plastic coated	0.4 - 2.0	1.3	1.0	0.8	16.0	7.5	10.0	20.0	111
69 03 130	018001	130	🟢	chrome plated	chrome plated	plastic coated	0.4 - 2.0	1.3	1.0	0.8	16.0	7.5	10.0	20.0	111

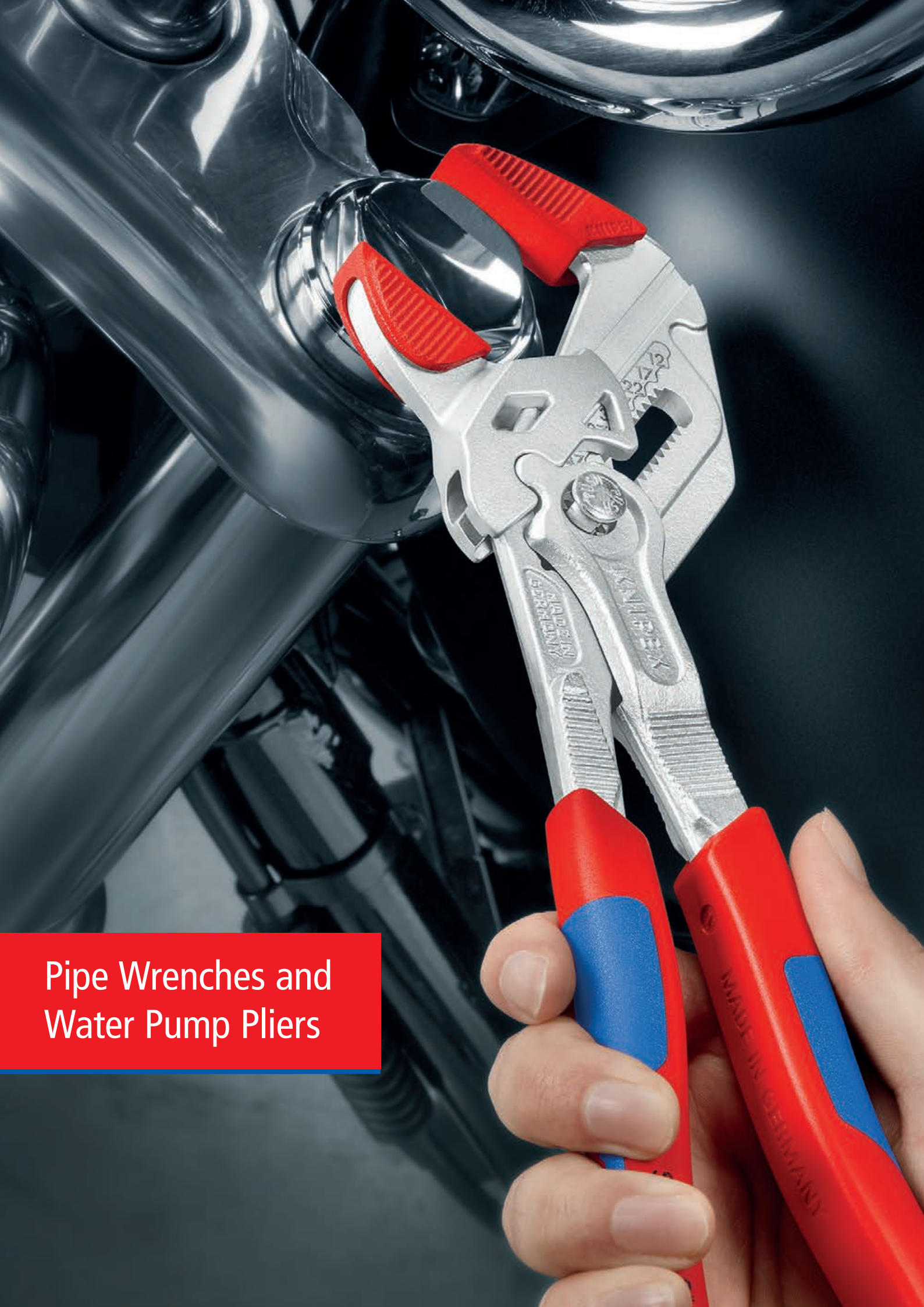

Pipe Wrenches and
Water Pump Pliers

Pliers Wrenches	104
Pliers Wrench XL	106
Set of Pliers Wrenches	106
Pliers Wrench protective jaws	107
Multiple Slip Joint Spanner	108
KNIPEX Smart Grip® – Water Pump Pliers	108
KNIPEX Cobra® XS – Hightech Water Pump Pliers	109
KNIPEX Cobra® – Hightech Water Pump Pliers	110
KNIPEX Cobra® XL / XXL – Hightech Water Pump Pliers	112
KNIPEX Cobra®-Set	113
KNIPEX Cobra® ...matic – Water Pump Pliers	113
KNIPEX Cobra® QuickSet – Hightech Water Pump Pliers	114
KNIPEX Cobra® VDE – Hightech Water Pump Pliers	115
KNIPEX Cobra® ES – Water Pump Pliers	115
KNIPEX Alligator® – Water Pump Pliers	116
KNIPEX Alligator® XL – Water Pump Pliers	118
Water Pump Pliers with groove joint	119
Mini Water Pump Pliers with groove joint	119
Pipe Wrenches 90°	120
Pipe Wrenches 45°	120
Pipe Wrenches S-type	121
Pipe Wrenches S-Type with fast adjustment	121
Siphon- and Connector Pliers	123

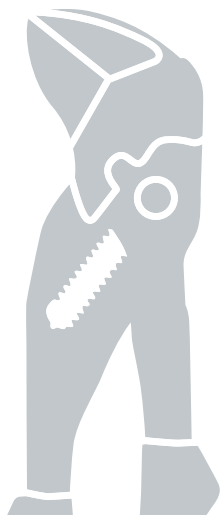

Pliers Wrenches

Pliers and a wrench in a single tool

- ▶ Replaces the need for sets of metric and imperial spanners
- ▶ Smooth jaws for damage free installation of plated fittings – working directly on chrome!
- > Adjustable tightening tool
- > Also excellent for gripping, holding, pressing and bending workpieces
- > Push the button for adjustment on the workpiece
- > Zero backlash jaw pressure prevents damage to edges of sensitive components
- > Parallel jaws give a more solid grip; its design allows flexible adjustment of all widths up to the specified maximum size
- > Reliable catching of the hinge bolt: no unintentional shifting
- > The ratchet type principle allows quick and easy tightening and release of all bolted connections
- > Lever transmission greater than 10 : 1 for strong gripping power
- > Fast adjustment by pushing a button directly on the workpiece
- > No unintentional shift of the gripping jaws and no slipping of the joint
- > Replaces the need for sets of metric and imperial spanners
- > Chrome vanadium electric steel, forged, oil-hardened

Length 150 mm

- > Ideal multi-purpose wrench in pocket size; indispensable companion in emergency tool kit

Length 180 mm

- > With narrow gripping jaws – for tightening situations that require a slim tool

86 01 180 / 86 01 250 / / 86 01 300 / 86 02 180 / 86 02 250 / 86 03 250 / 86 05 250 / 86 06 250

- > With scaling for presetting the width apart from the workpiece

86 43 250

- > 15° angled pliers handle provides space for counter screw connections or bolted fittings on surfaces

86 05 180 T / 86 05 250 T*

- > Pliers with tether attachment point for mounting a fall protection



86 01 250



86 02 250



86 03 125



86 01 180



86 02 180



86 01 300



86 03 150



86 03 180



86 03 180

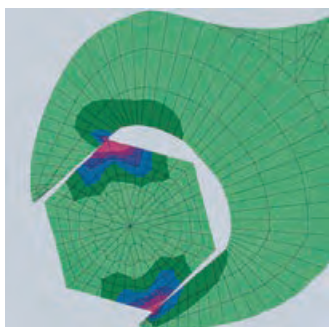

Conventional open end wrench: edge pressure causes surface damage

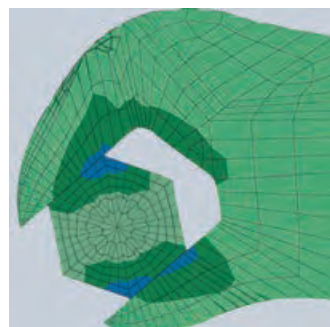

Pliers wrench: zero backlash contact pressure, no damage to edges

The smooth jaws grip all parallel surfaces in the capacity range with a high degree of pressure if necessary and open up almost unlimited application possibilities for the pliers wrench: e.g. for tightening locknuts, exerting pressure to activate the adhesive power of contact adhesives, edge breaking in tile work, snapping cable ties, utilisation as a small vice.

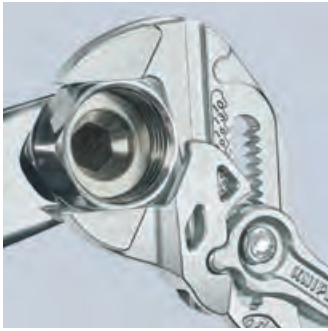

Working on plated fittings without damage of the surface



Replaces the need for sets of metric and imperial spanners



Ideal for bending operations



The mini pliers wrench for precision mechanics



Opening width lasered onto the pliers head (metric on the front and imperial on the back)



Fast adjustment at the touch of a button

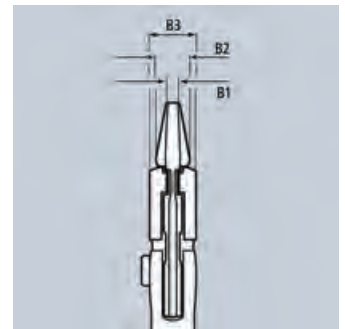

Article No.	EAN 4003773-	↔ mm		Pliers	Handles	⬡ Inch	⬡ mm	Adjustment positions	Dimensions			⚖ g
									B1 mm	B2 mm	B3 mm	
86 01 180	084273	180	▱	black atramentized	plastic coated	1 1/2	40	15	5.0	8.0	12.0	230
86 01 250	082385	250	▱	black atramentized	with non-slip plastic coating	2	52	19	8.0	8.0	14.0	465
86 01 300	084662	300	▱	black atramentized	with non-slip plastic coating	2 3/4	60	24	9.5	9.5	15.0	645
86 02 180	084280	180	▱	black atramentized	with multi-component grips	1 3/8	35	15	5.0	8.0	12.0	255
86 02 250	082392	250	▱	black atramentized	with multi-component grips	2	52	19	8.0	8.0	14.0	485
86 03 125	077497	125	▱	chrome plated	plastic coated	7/8	23	11	3.0	5.0	9.5	105
86 03 150	069676	150	▱	chrome plated	plastic coated	1	27	14	4.7	7.0	10.5	175
86 03 180	035466	180	▱	chrome plated	plastic coated	1 1/2	40	15	5.0	8.0	12.0	230
86 03 250	033837	250	▱	chrome plated	plastic coated	2	52	19	8.0	8.0	14.0	465
86 03 300	041429	300	▱	chrome plated	plastic coated	2 3/8	60	24	9.5	9.5	15.0	725
86 05 150	069928	150	▱	chrome plated	with multi-component grips	1	27	14	4.7	7.0	10.5	193
86 05 180	047162	180	▱	chrome plated	with multi-component grips	1 1/2	40	15	5.0	8.0	12.0	260
86 05 180 T	080121	180	▱	chrome plated	with multi-component grips, with integrated tether attachment point for a tool tether	1 1/2	40	13	5.0	8.0	12.0	280
86 05 250	047841	250	▱	chrome plated	with multi-component grips	2	52	19	8.0	8.0	14.0	490
86 05 250 T	080138	250	▱	chrome plated	with multi-component grips, with integrated tether attachment point for a tool tether	2	52	19	8.0	8.0	14.0	500
86 06 250	082408	250	▱ ⚡ 1000V	chrome plated	insulated with multi-component grips, VDE-tested	2	52	19	8.0	8.0	14.0	525
86 43 250	081296	250	▱ $\leq 15^\circ$	chrome plated	plastic coated	1 3/4	46	17	8.0	8.0	14.0	535

Pliers Wrench XL

Pliers and a wrench in a single tool

- ▶ The unique installation tool now also in 400 mm length
- ▶ For opening widths up to 85 mm / 3 3/8"

- > Also excellent for gripping, holding, pressing and bending workpieces
- > Optimised adjustment to the workpiece with hand-friendly position of grips
- > Reliable catching of the hinge bolt: no unintentional shifting
- > Lever transmission greater than 10 : 1 for strong gripping power
- > Adjustable tightening tool
- > Replaces diverse expensive, large open-end wrenches up to AF 85 mm or 3 3/8"
- > Parallel jaws give a more solid grip; its design allows flexible adjustment of all widths up to the specified maximum size
- > Smooth jaws, for damage free installation of quality union joints made from brass, red brass or stainless steel
- > Zero backlash jaw pressure prevents damage to edges of sensitive components
- > The ratchet type principle allows quick and easy tightening and release of all bolted connections
- > Push the button for adjustment on the workpiece
- > Chrome vanadium electric steel, forged, oil-hardened



86 03 400

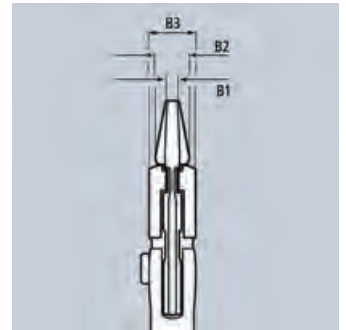

Article No.	EAN 4003773- mm	↔ mm	Pliers	Handles	Hexagon Inch	Hexagon mm	Adjustment positions	Dimensions			⚖ g
								B1 mm	B2 mm	B3 mm	
86 03 400	077312	400	chrome plated	plastic coated	3 3/8	85	25	12.5	16.0	20.0	1460

Set of Pliers Wrenches

5-piece

- > Tool roll made of hard-wearing polyester fabric
- > With hook-and-loop fastener
- > Equipped with pliers wrenches in five different lengths from 125 to 300 mm
- > Dimensions, open (L x H): 430 x 325 mm



00 19 55 S4

Article No.	EAN 4003773- mm	Quantity	⚖ g
00 19 55 S4	077817	1	2015
	86 03 125	1	
	86 03 150	1	
	86 03 180	1	
	86 03 250	1	
	86 03 300	1	

Pliers Wrench

with roughened jaws especially for opening plastic cable connectors

- > Pliers wrench with special laser shearing for a good hold: grip, compress or loosen the head of the cable tie, all without cutting it
- > Roughened jaws for a better grip
- > Also excellent for gripping, holding, pressing and bending workpieces
- > No unintentional shift of the gripping jaws and no slipping of the joint
- > Lever transmission greater than 10 : 1 for strong gripping power
- > Fast adjustment by pushing a button directly on the workpiece
- > Infinitely variable gripping of parallel surfaces up to the specified capacity by means of parallel jaws
- > Zero-backlash, full-surface contact
- > Chrome vanadium electric steel, forged, oil-hardened



86 05 150 S02

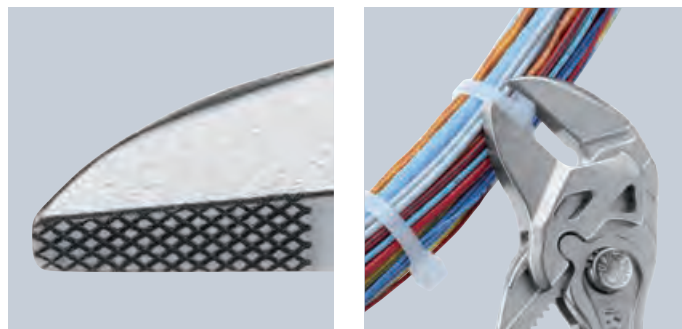

Article No.	EAN 4003773-	↔ mm		Pliers	Handles	⏏ Inch	⏏ mm	Adjustment positions	⚖ g
86 05 150 S02	071785	150	⊠	chrome plated	with multi-component grips	1	27	14	193

Protective jaws

for 86 XX 180 / 86 XX 250 / 86 XX 300

- > The perfect choice for designer fittings and other highly sensitive materials thanks to the soft, smooth gripping surfaces
- > Permits use on chrome if the jaws of the pliers wrench have been damaged due to improper or rough use
- > Easy to attach by hand and reliable fixing on the gripping jaws by means of an internal snap hook
- > Set consisting of 3 pairs of protective jaws made of plastic



86 09 250 V01



Article No.	EAN 4003773-	⚖ g
86 09 180 V01	085805	9
86 09 300 V01	085812	18
86 09 250 V01	084143	24

Multiple Slip Joint Spanner

- > For metric and imperial nuts and screws with widths across flats from 10 to 32 mm (3/8" up to 1 1/4"); self-locking from 17 mm: no slipping on the workpiece
- > Zero-backlash gripping of metric or imperial hexagonal headed screws, no rounding of bolt heads
- > Reliable and tight gripping of rounded, rusty, or thick coated bolts and screws
- > Ideal for work on vehicle brake systems
- > Quick tightening of bolted connections using ratchet action
- > Push the button for adjustment on the workpiece, also possible with one hand only
- > Fine adjustment for optimum adaptation to different sizes of workpieces and a comfortable handle width
- > Box-joint design for high stability due to double guide
- > Reliable catching of the hinge bolt: no unintentional shifting
- > Favourable lever action: optimum transmission of force
- > Pinch guard prevents operators' fingers being pinched
- > Replaces a set of wrenches, ideal for tightening locknuts
- > Chrome vanadium electric steel, forged, multi stage oil-hardened



87 41 250







Self-locking: no slip on workpieces; less effort required



In operation on rusted nut with rounded edges

The Raptor Pliers combines the convenience of the comfortable push-button adjustment on the workpiece and the function of an all-purpose tightening tool. Jaw gripping with zero backlash prevents slipping on the bolt head or rounding edges. Even rusty or thick coated bolted connections which have no surfaces capable of being gripped reliably by a conventional spanner can be managed by the exceptionally powerful closing gripping jaws of this spanner.



Article No.	EAN 4003773-	↔ mm		Pliers	Head	Handles	 Inch	 mm	Adjustment positions	 g
87 41 250	054566	250		grey atramentized	polished	with non-slip plastic coating	10 - 32	15	328	328

KNIPEX SmartGrip®

Water Pump Pliers with automatic adjustment

- > Ideal for frequent changeovers to workpieces of different sizes
- > Automatic adjustment per one-hand operation both for right-handed and left-handed use
- > Good access to the workpiece thanks to the slim dimensions of head and joint area and flush joint bolt
- > Self-locking on pipes and nuts: no slipping on the workpiece and low handforce required
- > Gripping surfaces with special hardened teeth, teeth hardness approx. 61 HRC: high wear resistance and stable gripping
- > Box-joint design for high stability due to double guide
- > Pinch guard prevents operators' fingers being pinched
- > Locking lever for space saving transport with reliable closed handles
- > Chrome vanadium electric steel, forged, multi stage oil-hardened
- > DIN ISO 8976









85 01 250

Adjustment to suit the workpiece is automatic with the KNIPEX SmartGrip®!

Place the outer jaw on the workpiece, squeeze the handles – turn!



Article No.	EAN 4003773-	↔ mm		Pliers	Head	Handles	 Ø Inch	 Ø mm	 mm	 g
85 01 250	061304	250		grey atramentized	polished	with non-slip plastic coating	1 1/4	32	36	370

KNIPEX Cobra® XS

- ▶ Optimum access in the narrowest spaces: an especially compact design with a very slim head
 - ▶ Single-handed fine adjustment by sliding for optimal fitting to various workpiece sizes
 - ▶ Long-lasting secure grip ensured by high wear resistance
- > Gripping capacity Ø 28 mm, width across flats up to 24 mm – at only 100 mm length
 - > Box joint: high quality and durability provided by dual guide
 - > Gripping surfaces with specially hardened teeth, hardness approx. 60 HRC
 - > Self-locking on pipes and nuts: no slipping on the workpiece and low handforce required
 - > Pinch guard prevents operators' fingers being pinched
 - > Fine adjustment with 11 adjustment positions
 - > DIN ISO 8976



87 00 100



Self-locking and durable – all part of genuine KNIPEX water pump pliers



Naked truth: The grips are not coated to keep them as slim as possible. To ensure good grip, they are texturised on the outside



Article No.	EAN	↔ mm		Pliers	Head	Handles	⊘ Inch	⊘ mm	⬡ mm	Adjustment positions	⚖ g
87 00 100	085836	100	(PATENTED)	grey atramentized	polished	embossed, rough surface	1	28	24	11	62

KNIPEX Cobra®

Hightech Water Pump Pliers

- > Push the button for adjustment on the workpiece
- > Fine adjustment for optimum adaptation to different sizes of workpieces and a comfortable handle width
- > Self-locking on pipes and nuts: no slipping on the workpiece and low handforce required
- > Gripping surfaces with special hardened teeth, teeth hardness approx. 61 HRC: high wear resistance and stable gripping
- > Box-joint design for high stability due to double guide
- > Reliable catching of the hinge bolt: no unintentional shifting
- > Pinch guard prevents operators' fingers being pinched
- > Chrome vanadium electric steel, forged, multi stage oil-hardened
- > DIN ISO 8976

87 02 250 / 87 02 250 T / 87 05 250

- > With slim multi-component grips without collar for better handling and easier transport

87 02 180 T / 87 02 250 T / 87 02 300 T*

- > Pliers with tether attachment point for mounting a fall protection

KNIPEX Cobra® – the Hightech Water Pump Pliers.

No more time-consuming presetting of the required opening size. Just position the upper jaw to the workpiece, push button and move close the lower jaw, ingeniously simple.



Fine adjustment by pushing a button: fast and comfortable



Fast and firm adjustment directly on the workpiece



87 01 125



87 01 250



87 02 180



87 02 180 T



87 03 250



87 05 250

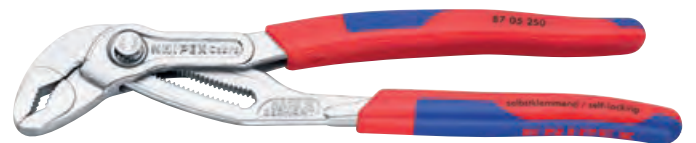

87 05 250



Teeth set against the direction of rotation have a self-locking effect and prevent slipping on the workpiece.

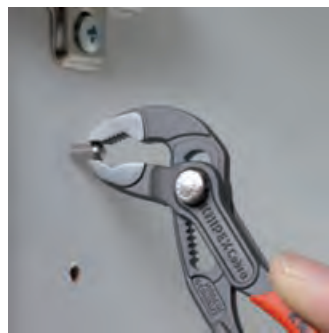
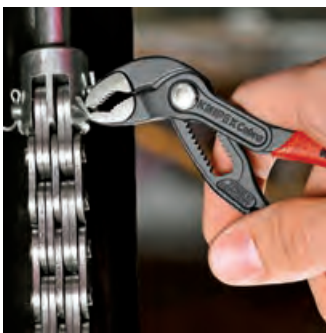

Article No.	EAN 4003773-	↔ mm		Pliers	Head	Handles	∅ Inch	∅ mm	mm	Adjustment positions	g
87 01 125	069935	125		grey atramentized	polished	with non-slip plastic coating	1	27	27	13	85
87 01 150	060116	150		grey atramentized	polished	with non-slip plastic coating	1 1/4	32	30	11	145
87 01 180	022015	180		grey atramentized	polished	with non-slip plastic coating	1 1/2	42	36	18	170
87 01 250	022022	250		grey atramentized	polished	with non-slip plastic coating	2	50	46	25	335
87 01 300	034087	300		grey atramentized	polished	with non-slip plastic coating	2 3/4	70	60	30	530
87 02 180	042396	180		grey atramentized	polished	with multi-component grips	1 1/2	42	36	18	196
87 02 180 T	080145	180		grey atramentized	polished	with multi-component grips, with integrated tether attachment point for a tool tether	1 1/2	42	36	18	200
87 02 250	040316	250		grey atramentized	polished	with slim multi-component grips	2	50	46	25	366
87 02 250 T	080152	250		grey atramentized	polished	with multi-component grips, with integrated tether attachment point for a tool tether	2	50	46	25	370
87 02 300	029144	300		grey atramentized	polished	with multi-component grips	2 3/4	70	60	30	580
87 02 300 T	080169	300		grey atramentized	polished	with multi-component grips, with integrated tether attachment point for a tool tether	2 3/4	70	60	30	600
87 03 125	073949	125		verchromt	verchromt	with non-slip plastic coating	1	25	27	13	85
87 03 180	005667	180		verchromt	verchromt	with non-slip plastic coating	1 1/2	42	36	18	175
87 03 250	043805	250		verchromt	verchromt	with non-slip plastic coating	2	50	46	25	335
87 03 300	041382	300		verchromt	verchromt	with non-slip plastic coating	2 3/4	70	60	30	530
87 05 250	005681	250		verchromt	verchromt	with slim multi-component grips	2	50	46	25	366
87 05 300	014126	300		grey atramentized	polished	with multi-component grips	2 3/4	70	60	30	580
87 09 125	074151	Assortment of spare parts for adjustment for 86 / 87-125									
87 09 150	074168	Assortment of spare parts for adjustment for 87 150									
87 09 180	034360	Range of spare parts adjustment for 87 180									

KNIPEX Cobra® XL / XXL

Water Pump Pliers

- > Greater gripping capacity but much lower weight than comparable pipe wrenches
- > Fast push-button adjustment directly on the workpiece, no unintentional slipping of the joint
- > Fine adjustment for optimum adaptation to different sizes of workpieces and a comfortable handle width
- > Self-locking on pipes and nuts: no slipping on the workpiece and low handforce required
- > Gripping surfaces with special hardened teeth, teeth hardness approx. 61 HRC: high wear resistance and stable gripping
- > Box-joint design for high stability due to double guide
- > Pinch guard prevents operators' fingers being pinched
- > Chrome vanadium electric steel, forged, multi stage oil-hardened
- > DIN ISO 8976



87 01 400

87 01 560

KNIPEX Cobra® XL
length 400 mm – weight 1195 g

gripping a union nut of a 2" pipe fitting
large gripping capacity of 95 mm,
would require a 3-inch pipe wrench



smaller dimensions and less weight than 1 1/2" pipe wrenches

2" pipe wrench
length 560 mm – weight 2670 g



gripping the 2" union nut exceeds the capacity of a 2" pipe wrench; no confident working conditions

Article No.	EAN 4003773-	↔ mm		Pliers	Head	Handles	∅ Inch	∅ mm	mm	Adjustment positions	⚖ g
87 01 400	005636	400		grey atramentized	polished	plastic coated	3 1/2	90	95	27	1195
87 01 560	044321	560		grey atramentized	polished	plastic coated	4 1/2	115	120	20	2780
87 09 400	034391	Range of spare parts adjustment for 87 400									
87 09 560	049845	Range of spare parts adjustment for 87 560									

KNIPEX Cobra® Set

5-piece

- > High-quality roll-up bag made from durable polyester fabric
- > With hook-and-loop fastener
- > Equipped with KNIPEX Cobra® high-tech water pump pliers in five different lengths from 125 to 300 mm
- > Dimensions, open (L x H): 430 x 325 mm



00 19 55 55

Article No.	EAN			Quantity	g
00 19 55 55	4003773-082613		Cobra® Set, 5-piece		1575
			87 01 125	1	KNIPEX Cobra®, Hightech Water Pump Pliers
			87 01 150	1	
			87 01 180	1	
			87 01 250	1	
			87 01 300	1	
00 19 55 55 LE	082620		Roll-up case for pliers wrenches, empty		260

KNIPEX Cobra®...matic

Water Pump Pliers

- > All features of the KNIPEX Cobra® 87 01 250
- > Automatic adjustment at the touch of a button directly on the workpiece
- > The sheltered positioned spring ensures that the pliers close automatically once the push-button is activated (one-hand operation!)
- > Chrome vanadium electric steel, forged, multi stage oil-hardened
- > DIN ISO 8976



87 11 250



Article No.	EAN	↔ mm		Pliers	Head	Handles	∅ Inch	∅ mm	∅ mm	Adjustment positions	g
87 11 250	035473	250		grey atramentized	polished	with non-slip plastic coating	2	50	46	25	335
87 19 250	022640			Spare spring for 87 11 250							

KNIPEX Cobra® QuickSet

Hightech Water Pump Pliers

- ▶ Fully open, push, grab!
- ▶ Additional fast adjustment on the workpiece by sliding the pliers handle
- > Combines the proven, reliable locking of the hinge bolt with an additional push function which makes it easier to work in very confined and inaccessible areas
- > The adjustment directly on the workpiece is possible by simply sliding the pliers handle
- > Reliable locking of the hinge bolt with the first workload. The gripping width of the pliers is then fixed and can only be adjusted by pressing the button
- > To re-activate the sliding function, the hinge bolt must be released by pressing the push button and the pliers must be completely opened again
- > Chrome vanadium electric steel, forged, multi stage oil-hardened
- > DIN ISO 8976



87 21 250



87 22 250

The KNIPEX Cobra® QuickSet combines all proven properties of the KNIPEX Cobra® with an additional push on function which makes it easier to work in very confined and inaccessible areas.

Adjustment directly on the workpiece is possible by simply sliding the pliers handle. The hinge bolt locks itself with the first workload. The gripping width of the pliers is then fixed and can only be adjusted by pressing the button. The hinge bolt must be released by pressing the button and the pliers must be completely opened once to activate the QuickSet function again.



Press the button – open pliers completely



Position jaw – simply slide and close pliers



Hinge bolt locks itself with the first workload



Article No.	EAN	↔ mm		Pliers	Head	Handles	∅ Inch	∅ mm	∅ mm	Adjustment positions	g
87 21 250	072775	250		grey atramentized	polished	with non-slip plastic coating	2	50	46	25	335
87 21 300	078524	300		grey atramentized	polished	with non-slip plastic coating	2 3/4	70	60	25	530
87 22 250	077794	250		grey atramentized	polished	with slim multi-component grips	2	50	46	25	366
87 29 01	079002	range of spare parts for 87 2x-250									
87 29 300	084570	range of spare parts for 87 21 300									

KNIPEX Cobra® VDE

Hightech Water Pump Pliers, insulated

- > Adjustment by shifting one jaw directly on to the workpiece: fast, reliable and comfortable handling
- > Fine adjustment: allows optimum adjustment to differently sized workpieces and comfortable handle position
- > Good access to the workpiece due to slim size of head and joint area
- > Self-locking on pipes and nuts: no slipping on the workpiece and low handforce required
- > Gripping surfaces with special hardened teeth, teeth hardness approx. 61 HRC: high wear resistance and stable gripping
- > Box-joint design for high stability due to double guide
- > Pinch guard prevents operators' fingers being pinched
- > Chrome vanadium electric steel, forged, multi stage oil-hardened
- > DIN ISO 8976, DIN EN 60900, IEC 60900



87 26 250



87 26 250 T

The adjustment action to adapt to the workpiece is easy and reliable with the KNIPEX Cobra® VDE: place the upper gripping jaw of the opened pliers on the workpiece, push pliers to close, done!

87 26 250 T*

- > Pliers with tether attachment point for mounting a fall protection

Article No.	EAN 4003773-	↔ mm		Pliers	Head	Handles	∅ Inch	∅ mm	∅ mm	Adjustment positions	⚖ g
87 26 250	071495	250		chrome plated	chrome plated	insulated with multi-component grips, VDE-tested	2	50	46	24	340
87 26 250 T	081517	250		chrome plated	chrome plated	insulated with multi-component grips, VDE-tested with integrated insulated tether attachment point for a tool tether	2	50	46	24	400
87 29 01	079002	range of spare parts for 87 2x-250									

KNIPEX Cobra® ES

Water Pump Pliers extra-slim

- > Ideal for service, maintenance and equipment repair, in automotive and general industry
- > Long, narrow jaws
- > Particularly good access to the workpiece due to very slim construction of head and joint area
- > Firm grip also on flat material due to three-point rest
- > Push the button for adjustment on the workpiece
- > Fine adjustment for optimum adaptation to different sizes of workpieces and a comfortable handle width
- > Self-locking on pipes and nuts: no slipping on the workpiece and low handforce required
- > Box-joint design for high stability due to double guide
- > Reliable catching of the hinge bolt: no unintentional shifting
- > Favourable lever action: optimum transmission of force
- > Pinch guard prevents operators' fingers being pinched
- > Chrome vanadium electric steel, forged, multi stage oil-hardened
- > DIN ISO 8976



Grips nuts up to 34 mm (1 5/8") across flats



Optimum access to the workpiece. Ideal for service, maintenance and equipment repair, in automotive and general industry



Very slim design in the complete head and joint area (compared to conventional water pump pliers)



87 51 250

Article No.	EAN 4003773-	↔ mm		Pliers	Head	Handles	∅ Inch	∅ mm	∅ mm	max. parallel opening width	max. gripping depth	Adjustment positions	⚖ g
87 51 250	061267	250		grey atramentized	polished	with non-slip plastic coating	1 1/4	32	34	37	42	19	328

*Other tools with tethering can be found from page 266

KNIPEX Alligator®

Water Pump Pliers

- ▶ Good access to the workpiece due to slim size of head and joint area
- ▶ More output and comfort compared to conventional water pump pliers of the same length: 9-notch adjustment positioning for 30 % more gripping capacity
- > Self-locking on pipes and nuts: no slipping on the workpiece and low handforce required
- > Gripping surfaces with special hardened teeth, teeth hardness approx. 61 HRC: high wear resistance and stable gripping
- > Box-joint design for high stability due to double guide
- > Robust construction, insensitive to dirt; particularly suitable for outdoor work
- > Pinch guard prevents operators' fingers being pinched
- > Chrome vanadium electric steel, forged, multi stage oil-hardened
- > DIN ISO 8976

88 02 250 / 88 02 250 T / 88 05 250

- > With slim multi-component grips without collar for better handling and easier transport

88 02 250 T / 88 02 300 T*

- > Pliers with tether attachment point for mounting a fall protection



88 01 180



88 02 250



88 02 250 T



88 02 300



88 02 300 T



88 03 250



88 05 250



88 05 300





Self-locking on pipes and nuts: no slipping on the workpiece; the complete actuating force can be used to turn the workpieces; not having to squeeze the pliers handles reduces the required effort

Conventional water pump pliers

KNIPEX Alligator® 250/300

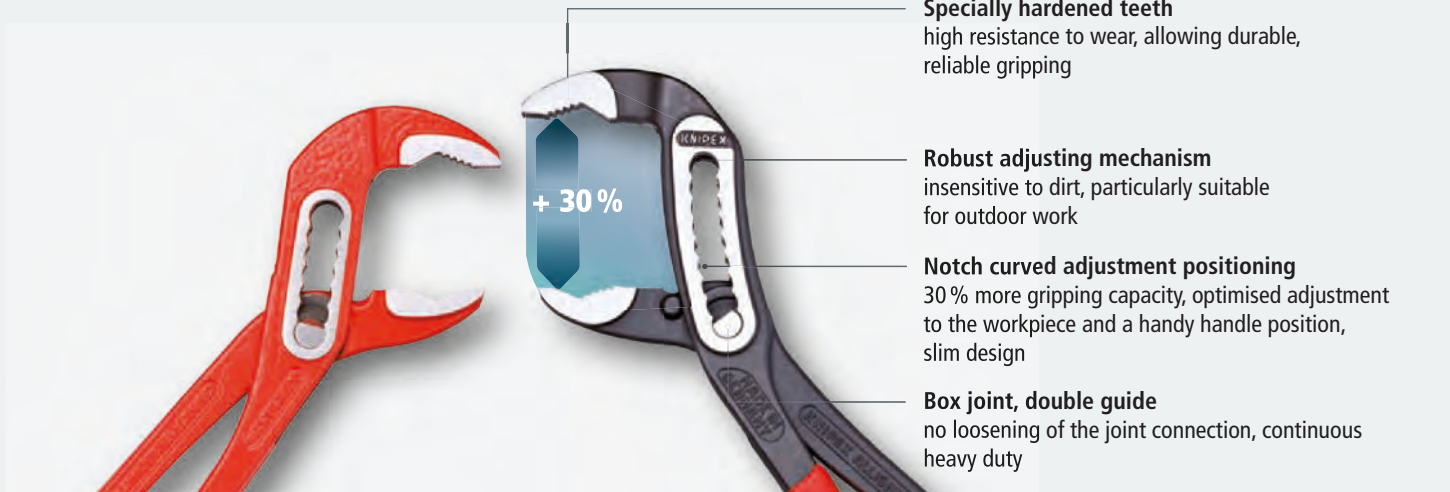

Specially hardened teeth
high resistance to wear, allowing durable, reliable gripping

Robust adjusting mechanism
insensitive to dirt, particularly suitable for outdoor work

Notch curved adjustment positioning
30% more gripping capacity, optimised adjustment to the workpiece and a handy handle position, slim design

Box joint, double guide
no loosening of the joint connection, continuous heavy duty

Article No.	EAN	↔ mm		Pliers	Head	Handles	∅ Inch	∅ mm	∅ mm	Adjustment positions	⚖ g
88 01 180	035480	180					1 1/2	42	36	9	180
88 01 250	022992	250	▨	black atramentized	polished	with non-slip plastic coating	2	50	46	9	331
88 01 300	034094	300					2 3/4	70	60	9	511
88 02 180	044222	180	▨	black atramentized	polished	with multi-component grips	1 1/2	42	36	9	210
88 02 300	029151	300					2 3/4	70	60	9	565
88 02 300 T	080183	300	▨	black atramentized	polished	with multi-component grips, with integrated tether attachment point for a tool tether	2 3/4	70	60	9	595
88 02 250	019282	250	▨	black atramentized	polished	with slim multi-component grips	2	50	46	9	347
88 02 250 T	080176	250	▨	black atramentized	polished	with slim multi-component grips, with integrated tether attachment point for a tool tether	2	50	46	9	370
88 03 180	042860	180					1 1/2	42	36	9	181
88 03 250	005742	250	▨	chrome plated	chrome plated	with non-slip plastic coating	2	50	46	9	319
88 03 300	019312	300					2 3/4	70	60	9	499
88 05 180	060130	180	▨	chrome plated	chrome plated	with multi-component grips	1 1/2	42	36	9	210
88 05 300	042389	300					2 3/4	70	60	9	560
88 05 250	035497	250	▨	chrome plated	chrome plated	with slim multi-component grips	2	50	46	9	344
88 06 250	039303	250	▨ ⚡ 1000 V	chrome plated	chrome plated	insulated with multi-component grips, VDE-tested	2	50	46	9	374
88 07 250	019343	250	▨ ⚡ 1000 V	chrome plated	chrome plated	with dipped insulation, VDE-tested	2	50	46	9	420
88 07 300	022350	300					2 3/4	70	60	9	661

KNIPEX Alligator® XL

Water Pump Pliers

- ▶ The classic model, now also in 400 mm length
- ▶ Robust construction, insensitive to dirt; particularly suitable for outdoor work

- > Good access to the workpiece due to slim size of head and joint area
- > Pinch guard prevents operators' fingers being pinched
- > Gripping surfaces with special hardened teeth, teeth hardness approx. 61 HRC: high wear resistance and stable gripping
- > Self-locking on pipes and nuts: no slipping on the workpiece and low handforce required
- > Box-joint design for high stability due to double guide
- > Robust adjustment mechanism, insensitive to dirt, easy to clean; particularly suitable for outdoor work
- > 11-notch adjustment positioning with a gripping capacity up to 3 1/2", optimised adjustment to the workpiece and user-friendly handle position
- > Chrome vanadium electric steel, forged, multi stage oil-hardened
- > DIN ISO 8976



88 01 400

The KNIPEX Alligator® XL offers the performance and comfort of a water pump pliers while being 50 % lighter in weight and having a greater gripping capacity (3 1/2") than comparable pipe wrenches. With their handy length of 400 mm, there is a place for KNIPEX Alligator® XL in every tool box.



Robust pliers for very hard applications

Gripping surfaces with special hardened teeth, teeth hardness approx. 61 HRC: low wear and stable gripping

Self-locking on pipes and nuts: no slipping on the workpiece and low handforce required

Box-joint design: high stability because of the double guide

Robust adjustment mechanism, insensitive to dirt, easy to clean; particularly suitable for outdoor work

11-notch adjustment for a gripping capacity up to 3 1/2", optimised adjustment to the workpiece and a comfortable handle position



Article No.	EAN	↔ mm		Pliers	Head	Handles	∅ Inch	∅ mm	∅ mm	Adjustment positions	g
88 01 400	075844	400		black atramentized	polished	with non-slip plastic coating	3 1/2	90.0	95.0	11	1190

Water Pump Pliers

with groove joint

- > Self-locking on pipes and nuts: no slipping on the workpiece and low handforce required
- > Non-slip joint
- > Jaw profile designed to fit screws and nuts
- > Joint design reduces strain of the centre bolt, hence no wear on pivot
- > Pinch guard prevents operators' fingers being pinched
- > Gripping surfaces with special hardened teeth, teeth hardness approx. 61 HRC for tool length 250 mm: high wear resistance and stable gripping
- > Chrome vanadium electric steel, forged, multi stage oil-hardened
- > DIN ISO 8976



Article No.	EAN 4003773-	↔ mm		Pliers	Head	Handles	∅ Inch	∅ mm	∅ mm	⚖ g
89 01 250	023067	250		black atramentized	polished	plastic coated	1 5/16	34	36	325
89 03 250	043829	250		chrome plated	chrome plated	plastic coated	1 5/16	34	36	325
89 05 250	043836	250		chrome plated	chrome plated	with multi-component grips	1 5/16	34	36	371

Mini Water Pump Pliers

with groove joint

- > Easy, convenient engagement in 4 different positions
- > Non-slip joint
- > Joint design reduces strain of the centre bolt, hence no wear on pivot
- > Chrome vanadium electric steel, forged, oil-hardened
- > DIN ISO 8976



Article No.	EAN 4003773-	↔ mm		Pliers	Head	Handles	∅ Inch	∅ mm	∅ mm	⚖ g
90 01 125	035503	125		black atramentized	polished	plastic coated	11/16	17	14	103
90 03 125	050490	125		chrome plated	chrome plated	plastic coated	11/16	17	14	105

Pipe Wrenches 90°

- > Swedish pattern
- > 90° angled jaws
- > Jaws with offset teeth in opposite direction
- > Teeth additionally induction-hardened
- > I-beam handle design
- > Captive adjusting nut
- > Red powder-coated, jaws bright ground
- > Chrome vanadium electric steel, forged, multi stage oil-hardened
- > DIN 5234



83 10 015



Article No.	EAN 4003773-	↔ mm		Pliers	⊘ Inch	⊘ mm	⊘ Inch	⚖ g
83 10 010	014188	310		red powder-coated	1 5/8	42	1	779
83 10 015	014195	420			2 3/8	60	1 1/2	1415
83 10 020	014201	560			2 3/4	70	2	2600
83 10 030	022329	650			4 3/8	110	3	3433
83 10 040	022336	750			5 1/8	130	4	4921

Pipe Wrenches 45°

- > Swedish pattern
- > 45° angled jaws
- > Jaws with offset teeth in opposite direction
- > Teeth additionally induction-hardened
- > I-beam handle design
- > Captive adjusting nut
- > Red powder-coated, jaws bright ground
- > Chrome vanadium electric steel, forged, multi stage oil-hardened
- > DIN 5234



83 20 015



Article No.	EAN 4003773-	↔ mm		Pliers	⊘ Inch	⊘ mm	⊘ Inch	⚖ g
83 20 010	014218	320		red powder-coated	1 5/8	42	1	817
83 20 015	014225	430			2 3/8	60	1 1/2	1408
83 20 020	014232	570			2 3/4	70	2	2596

Pipe Wrenches S-Type

- > Slim, S-type jaw
- > Jaws with offset teeth in opposite direction
- > Teeth additionally induction-hardened
- > Three-point contact on pipes, self-locking
- > I-beam handle design
- > Captive adjusting nut
- > Red powder-coated, jaws bright ground
- > Chrome vanadium electric steel, forged, multi stage oil-hardened
- > DIN 5234



83 30 015

Article No.	EAN 4003773-	↔ mm		Pliers	∅ Inch	∅ mm	∅ Inch	g
83 30 005	025221	245	▨	red powder-coated	1 1/2	35	1/2	472
83 30 010	014249	320			1 5/8	42	1	836
83 30 015	014256	420			2 3/8	60	1 1/2	1540
83 30 020	014263	540			2 3/4	70	2	2669
83 30 030	014164	680			4 3/4	120	3	4366

Pipe Wrenches S-Type

with fast adjustment

- > Pinch guard prevents operators' fingers being pinched
- > Time-saving, precise adjustment of the gripping width directly on the workpiece at the push of a button
- > Less effort required due to self-locking action
- > No unintentional shifting of the pliers handles
- > High wear resistance due to the additionally hardened teeth
- > Maximum load capability thanks to completely hardened handles
- > Chrome vanadium electric steel, forged, multi stage oil-hardened



83 60 010



83 61 010

Article No.	EAN 4003773-	↔ mm		Pliers	Handles	∅ Inch	∅ mm	∅ Inch	g
83 60 010	075424	330	▨	red powder-coated		1 5/8	42	1	955
83 60 015	075677	420				2 3/8	60	1 1/2	1470
83 60 020	078838	560				2 3/4	70	2	2420
83 61 010	077602	330	▨	grey powder-coated	plastic coated	1 5/8	42	1	955
83 61 015	077619	420				2 3/8	60	1 1/2	1470
83 61 020	078876	560				2 3/4	70	2	2480



Siphon and Connector Pliers

for traps, tube fittings and connectors

- ▶ Fine adjustment for ideal adjustment to diverse diameters
 - ▶ For siphons, oil filters, plastic pipes and connectors up to 80 mm diameter
 - ▶ Robust, heavy duty
- > Ideal for tightening and loosening siphon screw connections, plastic pipe fittings and round union nuts
 - > For connectors and couplings with screw connection, such as Cannon circular connectors
 - > For gentle loosening of hoses on nozzles and filter cartridges
 - > Optimum adhesion on dirt-, oil- and fatfree surfaces
 - > 25 adjustment positions, box-joint design
 - > Ergonomic handle geometry
 - > Chrome vanadium electric steel, forged, oil-hardened
 - > DIN ISO 8976

81 01 250 / 81 03 250

> With serrated gripping jaws; up to Ø 80 mm

81 11 250 / 81 13 250

> With exchangeable plastic jaws for sensitive surfaces; up to Ø 75 mm



81 01 250



81 03 250



81 11 250



81 13 250



Article No.	EAN	↔ mm		Pliers	Head	Handles	Working Capacity Ø mm	Adjustment positions	Δ g
81 01 250	078463	250		black atramentized	polished	with non-slip plastic coating	25 - 80	25	355
81 03 250	078487	250		chrome plated	polished	with non-slip plastic coating	25 - 80	25	355
81 11 250	078470	250		black atramentized	polished	with non-slip plastic coating	10 - 75	25	355
81 13 250	078494	250		chrome plated	chrome plated	with non-slip plastic coating	10 - 75	25	355
81 19 250	078500	2 pairs of plastic jaws for 81 11 250 / 81 13 250							

Special Pliers and Control Cabinet Keys



Ear Clamp Pliers	126
KNIPEX TwistCut® – Corrugated pipe cutters	127
KNIPEX TubiX® Pipe Cutter	128
Anvil Shears	129
KNIPEX PlastiCut® – Cutter for flexible hoses and plastic conduit pipes	129
Pipe cutters for multilayer and pneumatic hoses	130
Pipe cutters for plastic composite pipes	130
Cutter for ribbon cable	131
Mitre Shears for plastic and rubber sections	131
Vinyl Shears	132
Shears for KEVLAR® fibres	132
Combination Shears	133
Pipe Cutter for composite pipes and protective tubes	133
Pipe Cutter for composite and plastic pipes	134
Pipe Cutter for plastic conduit pipes	134
Punch Lock Riveters	135
Sheet Metal Nibbler	135
Notching Pliers	136
Cycle Pliers	136
Spring Hose Clamp Pliers	137
Hose Clamp Pliers for Click clamps	138
Revolving Punch Pliers	139
Tile Nibbling Pincer	139
Upholstery Pliers	140
Tile Breaking Pliers	140
Pliers for working on glass	141
Halogen Bulb Exchange Pliers	142
Magnetic LED Lamp	142
Material catcher	142
KNIPEX TwinKey® – Control Cabinet Keys	143
Control Cabinet Keys	143



Ear Clamp Pliers

Suitable for universal use, for 1-ear and 2-ear clamps

- > For the simple and reliable mounting of 1-ear and 2-ear clamps (Oetiker system or similar)
- > No damage to press points on the ear clamps
- > The slim head permits good accessibility in confined areas
- > Versatile use for clamps on CV boots, cooler and fuel lines, air pressure systems, compressors
- > Durable and strong
- > High-grade special tool steel, forged, oil-hardened

10 99 1220

- > Especially suitable for universal use thanks to the additional side jaw



10 98 1220



10 99 1220



Sealing the fluid hose on the connecting piece using the side press nib



Using the front press nib



Sealing the pneumatic hose on the quick action coupling



Article No.	EAN 4003773-	↔ mm	Pliers	Head	Handles	⚖ g
10 98 1220	080749	220	black atramentized	polished	plastic coated	363
10 99 1220	080756	220	black atramentized	polished	plastic coated	345

KNIPEX TwistCut®

Corrugated pipe cutters

- > For corrugated plastic pipes from Ø 13 - 32 mm and a ridge width of up to 2.7 mm
- > For cutting empty or ready-assembled corrugated pipes to length
- > Application in the electrical and construction trades and for plumbing work
- > Recessed blades prevent injuries
- > Exact, flush cut, without damaging the internal cables
- > Cut on the outside of fluting – no sharp raw edge inside the corrugated pipe
- > Fast and reliable work
- > Simple insertion of the corrugated pipe for reliable and simple cutting: no waste
- > In the case of thick-walled corrugated pipes, reapply after the circular cut just behind the cut, and break off the corrugated pipe
- > Slim and ergonomically shaped for work in poorly accessible areas
- > Double-sided guide for a precise cut
- > For corrugated pipes with Ø of 13 - 32 mm
- > Body made of stable polyamide compound plastic



90 22 01 SB



90 22 02 SB



Convenient handling due to fastener with locking device and opening by means of internal spring



Also for protective pipes on aluminium composite pipes in plumbing, up to a diameter of 32 mm



Clean cutting edge with no damage to internal cables as the cut is always at the top of the corrugation



Easy to use: press KNIPEX TwistCut® together, turn with slight pressure, done

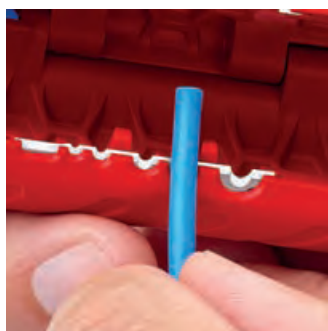

90 22 02 SB: Practical locator simplifies the insertion of single conductors for stripping



90 22 02 SB: Injection moulded length scale for consistent stripping to a uniform length, legible for left and right handed users

Article No.	EAN 4003773-	↔ mm		Cutting capacities Ø mm	Wire stripping value for conductors and strands Ø mm	⚖ g
90 22 01 SB	082286	100	⌘ (PAT. PEND.)	13 - 32		47
90 22 02 SB	082293	100	⌘ (PAT. PEND.)	13 - 32	0.2 - 4	47

KNIPEX TubiX® Pipe Cutter

With one hand only: cuts copper, brass or stainless steel quickly and easily

- ▶ QuickLock single-handed quick adjustment: slide on, cut – finished!
 - ▶ Easy one-handed pushing for quick adjustment to different tube sizes
 - ▶ Comfortable and easy working thanks to high-quality needle bearings in the cutting wheel and the guide rolls
- > Cuts pipes from Ø 6 - 35 mm (1/4" - 1 3/8") with wall thickness up to 2 mm
- > Cutting wheel made of high-grade ball-bearing steel
- > Practical quick replace system for the cutting wheel – with spare wheel stored under the feeding barrel
- > With precision-ground deburring tool, easy to remove
- > Light and durable metal enclosure of magnesium

← The overall length does not change during operation →



90 31 02

PAT. PEND.



The needle-bearing and spring-loaded cutting wheel made of high-quality ball bearing steel is easily exchangeable



The spring-loaded cutting wheel can be pushed and fixed on the diameter of the pipe with the single-handed quick adjustment



Speed in everyday operation: the QuickLock single-handed quick adjustment enables the cutting wheel to slide onto any pipe diameter with a single press of the thumb



High-quality needle bearings enable the cutting wheel and the four guide rollers to operate virtually without any friction during the cutting – cuts stainless steel pipes with particular ease

Four steps to success – how the KNIPEX TubiX® pipe cutter helps you in your work



1 Cutting now made easy: position the opened KNIPEX TubiX®...



2 Push the cutting wheel against the pipe with the QuickLock single hand quick adjustment: fastest adjustment to different pipe diameters



3 Tighten and cut with a swift twist and then readjust using the ergonomic blue feeding barrel...



4 and you're done! If necessary, have the edge smoothed out using the fold-out deburring tool – with surprisingly little effort

Article No.	EAN 4003773-	↔ mm	Ø mm	Ø Inch	⚖ g
90 31 02 SB	084686	260	6 - 35	1/4" - 1 3/8"	375
90 31 02 BK	084907	260	6 - 35	1/4" - 1 3/8"	375
90 39 02 V01	085874	Cutting wheel INOX Cu for KNIPEX TubiX® 90 31 02			8
90 39 02 V02	085881	Deburring tool for KNIPEX TubiX® 90 31 02			7

Anvil Shears

- > Drawing cut against firm surface for cutting soft materials without damage, e.g. rubber profiles, PVC, leather, wood, hoses etc.
- > Cuts flat material with a max. width of 40 mm and height of 7.5 mm
- > Cutting capacity for round material up to \varnothing 25 mm
- > Strong, replaceable blade
- > With opening spring and locking device
- > Tool body: tool steel, rolled, oil-hardened



94 55 200



Article No.	EAN 4003773-	↔ mm		Tool	Handles	Blade length mm	⚖ g
94 55 200	080763	200	MM	chrome plated	with plastic grips	40	290
94 59 200 01	080916	Spare blade for 94 55 200					

KNIPEX PlastiCut®

Cutter for flexible hoses and plastic conduit pipes

- > For cutting thin walled plastic pipes (conduit plastic pipes) and flexible hoses, also with fabric reinforcement, of plastic and rubber up to 25.0 mm / 1" exterior dia.
- > Not suitable for cutting cables
- > With opening spring and locking device
- > Blades: special tool steel, oil-hardened, interchangeable
- > Tool body: plastic, fibreglass-reinforced



90 20 185



With replaceable blade

Article No.	EAN 4003773-	↔ mm		Cutting capacities Ø mm	⚖ g
90 20 185	067122	185	MM	25	172
90 29 185	067139	Spare blade for 90 20 185			

Pipe cutters for multilayer and pneumatic hoses

- ▶ Ideal for all liquid, multilayer and pneumatic hoses/pipes commonly available on the market in the wide application range from Ø 4 - 20 mm
- ▶ With universal support for right-angled positioning
- ▶ Easy on the hands even in continuous use thanks to low force required and automatic opening thanks to the spring mechanism

- > Exchangeable blade
- > With opening spring and locking device
- > Ergonomically designed glass-fibre reinforced plastic handles
- > Not suitable for cutting cables
- > Blade made of high-strength special grade steel, oil-hardened and tempered

Article No.	EAN 4003773-	↔ mm	Cutting capacities Ø mm	⚖ g
90 10 185	084846	185	4 - 20	175
90 29 01	031932	Spare blade for 90 25 20 / 90 10 185 / 90 25 185		



90 10 185



Pipe cutters for plastic composite pipes

- ▶ For cutting composite pipes from Ø 12 - 25 mm
- ▶ Clean, smooth and burr-free cut surfaces
- ▶ Easily exchangeable blades

- > With opening spring and locking device
- > Ergonomically designed glass-fibre reinforced plastic handles
- > Not suitable for cutting cables
- > Blade made of high-strength special grade steel, oil-hardened and tempered

Article No.	EAN 4003773-	↔ mm	Cutting capacities Ø mm	⚖ g
90 25 185	084839	185	12 - 25	175
90 29 01	031932	Spare blade for 90 25 20 / 90 10 185 / 90 25 185		



90 25 185



The high-strength, sharp blade cuts composite and plastic pipes smoothly and free of burr

Cutter

for ribbon cable

- > For crush-free cutting of ribbon cable up to 56 mm width
- > Exchangeable cutting base with try square for rectangular cuts
- > With opening spring and locking device
- > Blade: standard trapezoidal blade, replaceable
- > Tool body: tool steel, rolled, oil-hardened



94 15 215

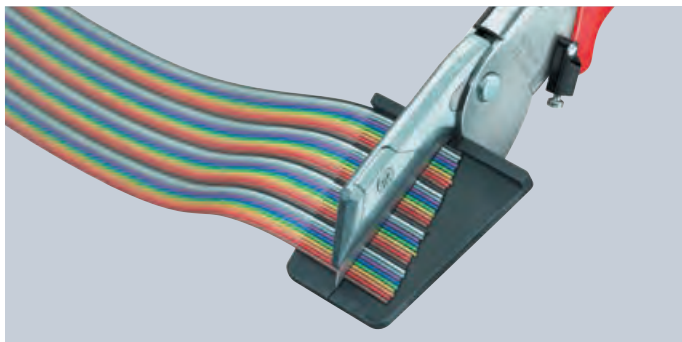

Article No.	EAN 4003773-	↔ mm		Tool	Handles	Blade length mm	⚖ g
94 15 215	046011	215		chrome plated	with plastic grips	56	346
94 19 02	052333	Blade support for 94 15 215					
94 19 215	046219	Set with 10 spare blades for 94 15 215 / 94 35 215					

Mitre Shears

for plastic and rubber sections

- > For crush-free cutting of plastic, rubber and soft timber sections; also for ribbon cable
- > Exchangeable cutting base with try square for 45°-cuts and markings for 60°, 75°, and 90°-cuts
- > With opening spring and locking device
- > Blade: standard trapezoidal blade, replaceable
- > Tool body: special tool steel, rolled, oil-hardened



94 35 215



Article No.	EAN 4003773-	↔ mm		Tool	Handles	Blade length mm	⚖ g
94 35 215	046028	215		chrome plated	with plastic grips	56	397
94 19 215	046219	Set with 10 spare blades for 94 15 215 / 94 35 215					

Vinyl Shears

also for cable ducts

- > For cutting and shortening cable ducts, also for plastic material
- > Special lever transmission
- > Very effective blade geometry
- > Blade: special tool steel, oil-hardened
- > Tool body: high-grade chrome vanadium electric steel, oil-hardened



95 02 21



Blade length 110 mm for cutting wide cable ducts

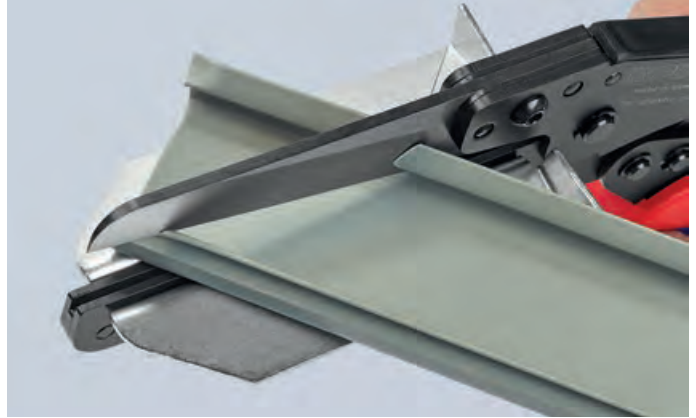

Article No.	EAN 4003773-	↔ mm		Tool	Handles	Cutting capacities mm	Blade length mm	⚖ g
95 02 21	052128	275	MM (PATENTED)	burnished	with multi-component grips	max. 4	110	665

Shears

for KEVLAR® fibres

- > Only for cutting fibres of KEVLAR® in optical fibre cables, not recommended for other materials
- > Precisely ground blades with serration prevent the fibres from slipping and guarantee a clean cut
- > Riveted precision joint, for low-friction movement and smooth and even cutting of the thin KEVLAR® fibres
- > Hard-chrome plated, ground surface
- > Shears body: chrome vanadium electric steel, oil-hardened
- > User-friendly handles: plastic, impact-proof



95 03 160 SB



KEVLAR® is a registered trademark of E. I. du Pont de Nemours and Company

Article No.	EAN 4003773-	↔ mm		Shears	Handles	⚖ g
95 03 160 SB	043362	160		chrome plated	plastic coated	85

Combination Shears

- > For cutting cardboard, plastics, aluminium, brass and copper foils
- > Not suitable for steel wire or iron sheets
- > Precision-ground, hardened blades
- > With opening spring and locking device
- > Pinch guard prevents operators' fingers being pinched
- > Adjustable bolted joint
- > Shears body: surgical steel, stainless, vacuum-hardened
- > Handles: plastic, impact-proof

95 05 185

- > Angled shape – for easy execution of long cuttings; ergonomically shaped plastic handles



95 05 140



95 05 185



95 05 190

Article No.	EAN 4003773-	↔ mm		Head	Handles	△ g
95 05 140	019589	140	MM	polished	plastic coated	67
95 05 185	060277	185	∠40° MM	polished	plastic coated	115
95 05 190	019602	190	MM	polished	plastic coated	116

Pipe Cutter

for composite pipes and protective tubes

- > For cutting composite pipes with diameters from 12.0 to 25.0 mm and for cutting flexible protective tubes with a diameter of 18.0 - 35.0 mm without damaging a potential pipe inside
- > A calibration arbor can be fitted, for example for Geberit composite pipes with 11.5 and 15.0 mm dia.
- > Blades: special tool steel, oil-hardened, interchangeable
- > Tool body: high-grade chrome vanadium electric steel, oil-hardened



90 25 20



Clean cut of protective tubes 18 - 35 mm diameter

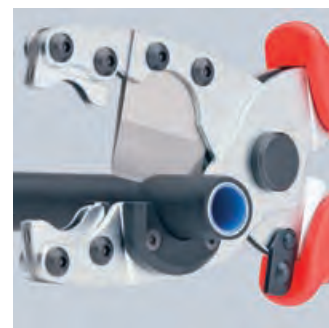

Composite pipes of 12 - 25 mm dia. are cut cleanly and without deformation

Article No.	EAN 4003773-	↔ mm	Tool	Handles	Cutting capacities composite pipes Ø mm	Cutting capacities protective tubes Ø mm	Blade length mm	△ g
90 25 20	046004	210	MM (PATENTED)	galvanized with multi-component grips	12 - 25	18 - 35	25	332

90 29 01 031932 Spare blade for 90 25 20 / 90 10 185 / 90 25 185

90 29 02 031949 1 pair of spare blades for 90 25 20 (protective pipes)

90 29 15 031956 Calibration arbor for 90 25 20 (Geberit pipes)

Pipe Cutter

for composite and plastic pipes

- > For cutting thick walled plastic and composite pipes with diameters
- > Cuts pipes using the ratchet principle in several strokes
- > Self-adapting pipe support positions pipes of various diameters correctly for a rectangular cut
- > Blades: special tool steel, oil-hardened, interchangeable
- > Tool body: high-grade chrome vanadium electric steel, oil-hardened



90 25 40



Clean cut of thick walled plastic and composite pipes



Not suitable for thin-walled plastic pipes. Please use article number 90 20 185 or 94 10 185 for these



Article No.	EAN 4003773-	↔ mm		Tool	Handles	Cutting capacities Ø mm	Cutting edge length mm	⚖ g
90 25 40	045182	210	MM (PATENTED)	galvanized	with multi-component grips	26 - 40	40	500
90 29 40	045199	Spare blade for 90 25 40						

Pipe Cutter

for plastic conduit pipes

(electrical installation work)

- > For clean cutting of thin-walled plastic pipes (e.g. plastic conduit pipes) with Ø 6.0 - 35.0 mm
- > Not suitable for cutting cables
- > Blade is replaceable and can be retracted from any position
- > Low force requirement due to special blade geometry and optimum transmission
- > Minimum operator fatigue due to ergonomic handle design and incremental ratchet blade feed
- > Blade: special tool steel, oil-hardened
- > Housing: die-cast aluminium, red lacquered



94 10 185



Article No.	EAN 4003773-	↔ mm		Body	Cutting capacities Ø mm	Cutting edge length mm	⚖ g
94 10 185	047025	185	MM	die-cast aluminium body, red lacquered	6 - 35	35	583
94 19 185	047032	Spare blade for 94 10 185					
94 19 02	052333	Blade support for 94 15 215					

Punch Lock Riveters

- > To join metal section sheets used in dry walling for dividing walls and drop ceilings, without needing screws or rivets
- > For U- and C-shaped sections with max 1.2 mm metal (2 x 0.6 mm)
- > Minimum handforce required due to optimum lever transmission
- > Pliers body: special tool steel, rolled, oil-hardened

90 42 250

- > For one-hand operation

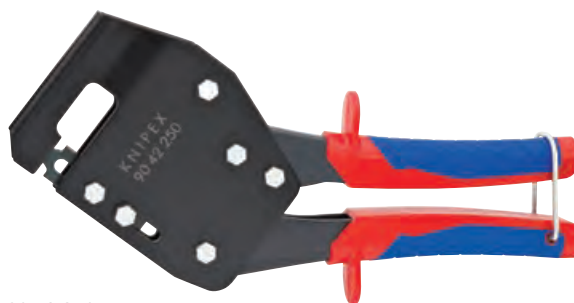

90 42 250



The punching tool is squeezed through the metal section sheets



Setting the pliers for connection of two metal section sheets



90 42 340

Article No.	EAN 4003773-	↔ mm		Pliers	Handles	Capacity	⚖ g
90 42 250	047865	250	MM	burnished	with multi-component grips	max. 1.2 (2 x 0.6)	676
90 42 340	071884	340		burnished	with multi-component grips	max. 1.2 (2 x 0.6)	901
90 49 340	028079	Spare punch for 90 42 340					
90 49 340 M	028499	Spare die for 90 42 340					

Sheet Metal Nibbler

- > For cutting iron, copper or aluminium sheet metal up to max. 1.2 mm thickness, plastic up to max. 2.0 mm thickness
- > Materials are cut without deformation
- > Clean cut edges - no trimming activities needed
- > With chip breaker
- > Easy handling
- > Cutting width: 2.7 mm
- > Blades: special tool steel, oil-hardened, interchangeable
- > Tool body: special tool steel, rolled, oil-hardened

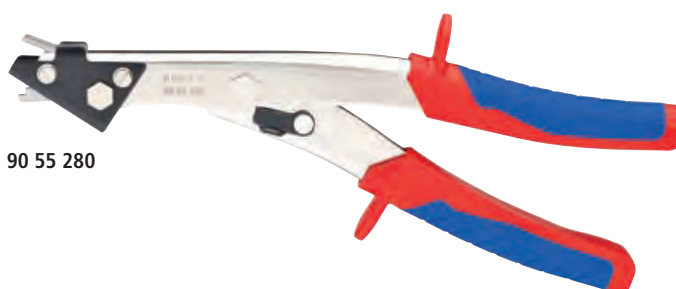

90 55 280

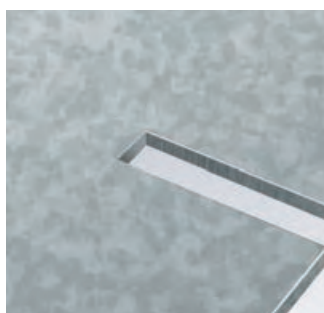

Notching and chip breaking in a single pass



Notching without chip breaking

Article No.	EAN 4003773-	↔ mm		Tool	Handles	⚖ g
90 55 280	026730	280	MM	nickel plated	with multi-component grips	461
90 59 280	027355	Spare blade for 90 55 280				

Notching Pliers

- > Special pliers for notching recesses into plastic ledges and plastic casings for electric and sanitary installation
- > Notches can be enlarged by initial and final cut
- > Clean cut edges – no trimming activities needed
- > Easy handling
- > With opening spring, opening limiter and locking lever
- > Pliers body: special tool steel, rolled, oil-hardened





90 61 16



90 61 20



The KNIPLEX Notching Pliers produces the most common notches in plastic ledges and cable ducts in a simple, fast and clean way. No time-consuming sawing out or nibbling and no additional work required.

Article No.	EAN 4003773-	↔ mm		Pliers	Handles	Capacity	⚖ g
90 61 16	051947	250		burnished	with plastic grips	16 x 32 mm	403
90 61 20	051954	250				20 x 29 mm	414

Cycle Pliers

- > For very narrow screw connections
- > Special tool steel, forged, oil-hardened

84 11 200



- > Straight head



84 11 200



84 21 200

Article No.	EAN 4003773-	↔ mm		Pliers	Head	Handles	Recess Ø mm	Head thickness mm	⚖ g
84 11 200	052265	200		black atramentized	polished	plastic coated	10	3.5	180
84 21 200	051930	200	 $\leq 20^\circ$	black atramentized	polished	plastic coated	10	3.5	182

Spring Hose Clamp Pliers

- > Rotating, universal grip inserts for reliably gripping the clamps in all positions
- > Jaw inserts can also be rotated under load
- > Extremely good leverage which allows clamps to be opened easily without great effort
- > Slim head design; narrow head width, rotating grip inserts make this an ideal tool, especially in confined areas
- > Additional function: detach hoses gently using the serrated jaw
- > Chrome vanadium electric steel, forged, oil-hardened

85 51 250 AF

- > The locking device enables simple and secure work on clamps under tension without effort



85 51 180 A



85 51 250 A



85 51 250 AF



A single pair of pliers for various sizes of clamps and spring band clamps. Rotating jaw inserts enable them to adapt to any position while still guaranteeing that clamps are securely positioned in the pliers.

APPLICATION AREAS CARS/TRUCKS Air suction, cooling, charge air, water return, thermostat, fuel, heating

The proven features of the Cobra® also apply to the KNIPEX Spring Hose Clamp Pliers

- > Less effort required due to extremely good transmission ratio
- > First class guard to prevent fingers being pinched
- > Reliable gripping with hand-friendly handle position
- > Fine adjustment ensures a precise fit to suit the most diverse clamp sizes
- > Opens at the touch of a button
- > Box-joint design: high stability due to the double guidance

Article No.	EAN 4003773-	↔ mm	Pliers	Handles	Capacity	Adjustment positions	⚖ g
85 51 180 A	081159	180	grey afromentized	with non-slip plastic coating	max. 50 mm	15	190
85 51 250 A	077329	250	grey afromentized	with non-slip plastic coating	max. 70 mm	25	345
85 51 250 AF	078623	250	grey afromentized	with non-slip plastic coating	max. 70 mm	19	350
85 59 250 A	077336	Spare parts assortment grip inserts, for 85 51 250 A / 85 51 250 AF					

Hose Clamp Pliers

for Click clamps

► To open and close Click clamps

- > Rotating jaw inserts for the safe actuation of clamps in any position
- > Good leverage which allows clamps to be opened and closed again comfortably and easily without a great deal of effort
- > For easy working on fuel hoses, vacuum pipes and suction nozzles and many other applications
- > Additional function: detach hoses gently using the serrated jaw
- > Slim head design; narrow head width, rotating grip inserts make this an ideal tool, especially in confined areas
- > Chrome vanadium electric steel, forged, oil-hardened



85 51 180 C



85 51 250 C



Serrated gripping jaws for easy loosening of tight hoses

The proven advantages of the Cobra® also apply to this KNIPEX Hose Clamp Pliers

- > Guard prevents operators' fingers being pinched
- > Reliable gripping with hand-friendly handle position
- > Box-joint design for high stability due to double guide



Article No.	EAN 4003773-	↔ mm	Pliers	Handles	⚖ g
85 51 180 C	081166	180	grey atramentized	with non-slip plastic coating	170
85 51 250 C	078517	250			345
85 59 250 C	078999	Spare parts assortment grip inserts, for 85 51 180 C / 85 51 250 C			

Revolving Punch Pliers

- > To punch holes into leather, textiles and plastic material
- > With six interchangeable punches: 2.0 / 2.5 / 3.0 / 3.5 / 4.0 / 5.0 mm dia.
- > With opening spring and locking device
- > Powder-coated for reliable protection against rust
- > Pliers body and punches: special tool steel, oil-hardened



90 70 220



Interchangeable punches

Article No.	EAN 4003773-	↔ mm		Pliers	⚖ g
90 70 220	019411	220	MM	red powder-coated	251

Tile Nibbling Pincer

Parrot Beak Pincer

- > Enlarges holes in tiles and forms tile edges
- > Special tool steel, forged, oil-hardened



91 00 200



Article No.	EAN 4003773-	↔ mm	Pliers	Head	⚖ g
91 00 200	013754	200	black atramentized	polished	158

Upholstery Pliers

- > For the professional fixing of seat covers on profiled seats to the seat frame with all popular upholstery clips
- > Securely insert upholstery clips, guide and hold: the special groove fixes the upholstery clips in the correct position
- > Easy positioning of the upholstery clips: a closing spring holds the pliers closed, the clip can be securely positioned and pressed
- > User-friendly operation thanks to multi-component grips
- > Upholstery clips can be easily pressed together due to a good transmission ratio of the pliers
- > Durable and strong
- > Special tool steel, forged, oil-hardened



91 92 180



Article No.	EAN	↔ mm	Pliers	Handles	⚖ g
91 92 180	4003773-080725	185	mirror polished	with multi-component grips	195

Tile Breaking Pliers

Work without cutting-off machine, particularly for fine strips. For less mess, dust, noise and effort.

- ▶ For the precise cutting (breaking) of tiles and porcelain stoneware after scoring with a tile cutter
- ▶ Ideal for long and thick tiles
- > Ideal protection of tiles against damage: replaceable positioning jaw made from soft, stable plastic
- > Great crushing force thanks to 10-fold increase of manual force
- > Easily adjusted to the required tile thickness at the press of a button
- > Chrome vanadium electric steel, forged, oil-hardened

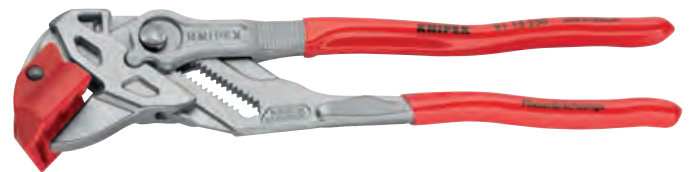

91 13 250



Plastic positioning jaw: tilting for a clean break line and optimum protection of the tiles against damage

Article No.	EAN	↔ mm	Pliers	Handles	⚖ g
91 13 250	4003773-079538	250	chrome plated	plastic coated	560
91 19 250 01	079545	Spare jaw for 91 13 250			

Glass Breaking Pincer

- > For breaking glass to a scored line
- > Special tool steel, forged, oil-hardened



91 31 180

Article No.	EAN 4003773-	↔ mm		Pliers	Head	Handles	Jaw width mm	⚖ g
91 31 180	069744	180		black atramentized	polished	plastic coated	24	245

Glass Nibbling Pincers

- > For breaking off narrow strips of glass to a scored line
- > For finishing off glass edges to required profile
- > Special tool steel, forged, oil-hardened

91 71 160

- > Narrow version, with opening spring



91 51 160



91 71 160

Article No.	EAN 4003773-	↔ mm		Pliers	Head	Handles	Jaw width mm	⚖ g
91 51 160	014355	160		black atramentized	polished	plastic coated	9.5	148
91 71 160	019565	160		black atramentized	polished	plastic coated	4.0	141

Flat Nose Grozing Pliers

- > With soft gripping jaws
- > For trimming glass edges, e. g. when making leaded glass windows
- > Special tool steel, forged



91 61 160

Article No.	EAN 4003773-	↔ mm		Pliers	Head	Handles	Jaw width mm	⚖ g
91 61 160	019527	160		black atramentized	polished	plastic coated	9.5	141

Halogen Bulb Exchange Pliers

- > For the installation of wedge base bulbs
- > Gripping surfaces plastic coated
- > Chrome vanadium electric steel, forged, oil-hardened

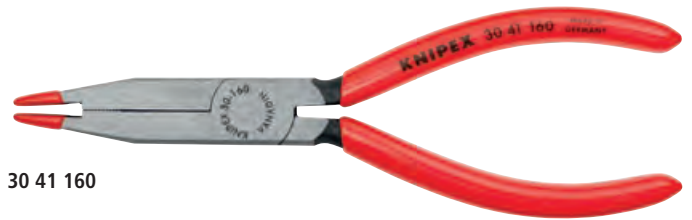

30 41 160



Article No.	EAN 4003773-	↔ mm	Pliers	Head	Handles	⚖ g
30 41 160	048480	160	black atramentized	polished	plastic coated	120

Magnetic LED Lamp

- > For illuminating dark working areas
- > Attachment to tool by means of strong magnets
- > Very compact dimensions
- > Approx. 24 hours of lighting, with 2 replaceable button cells (CR1220)
- > Snap-hook fastening
- > Impact-resistant plastic housing



00 11 V50



Article No.	EAN 4003773-	⚖ g
00 11 V50	075387	8

Material catcher

for 79 02 / 22 125 ESD

- > Material catcher for Electronics Diagonal Cutters: reliably prevents cut material from falling down
- > For particular safety, e.g. in the aerospace industry, in order to avoid FOD (Foreign Object Damage)



00 11 V79

Also suitable for the following pliers:



Easy attachment: the material catcher is easily attached and fastens securely to the pliers head



Remove the head of the cable tie using the Electronics Diagonal Cutter...



...the detached workpiece remains safely in the material catcher



79 02 125



79 02 125 ESD



79 22 125



79 22 125 ESD

Article No.	EAN 4003773-	⚖ g
00 11 V79	083443	20

KNIPEX TwinKey®

for all standard cabinets and shut-off systems

- ▶ 10 profiles. 2 crosses. 1 key.
- ▶ All common locking systems
- > Multifunctional key for the actuation of locking systems from the areas of facilities engineering (heating and sanitation, air conditioning, electro technology), gas and water supply and shut-off-systems
- > 8-arm version: two 4-way spider keys connected in a space-saving way using magnets
- > Reversible bit: 1,0 x 7 mm slot and PH2 cross slot
- > Key and reversible bit joined by stable stainless steel wire
- > Weight-optimised zinc die-cast design



00 11 01

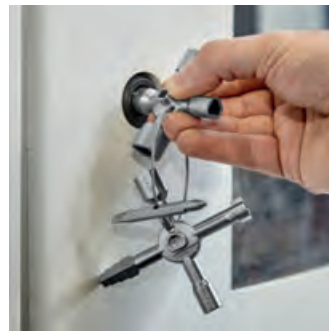
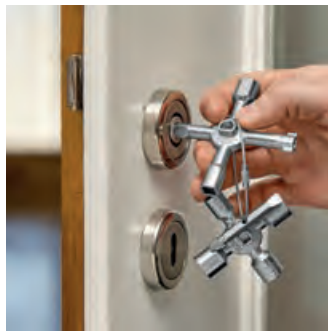

Article No.	EAN 4003773-	↔ mm	⊞ Ø mm	⊞ Ø mm	⊞ Ø mm	⊞ Ø mm	⊞ Ø mm	⚖ g
00 11 01	074670	92	5 / 6 - 7 / 8 - 9 / 10 - 11	7 - 8 / 9 - 10 / 11 - 12	3 - 5	6	6 - 9	135

Control Cabinet Keys

for all standard cabinets and shut-off systems

- > For control cabinets and shut-off systems in the supply of gas, water and electricity
- > For technical installations in buildings, e.g. air conditioning and ventilation systems, shut-off valves, mains switchboards, etc.
- > With bit insert: slot 1.0 x 7 mm and cross recess PH2
- > With adapter for 1/4" bits chained to key
- > Additional bit adapter for 1/4" bits inside one profile
- > Zinc die-casted

00 11 02

- > Short version, total length 44 mm

00 11 03

- > Long execution, total length 76 mm



00 11 03

Article No.	EAN 4003773-	↔ mm	⊞ Ø mm	⊞ Ø mm	⊞ Ø mm	⚖ g
00 11 02	048947	44	6 / 8	9	3 - 5	65
00 11 03	041658	76	5 / 6 / 8	9	3 - 5	88

Profi-Key

for all standard shut-off systems

- > Key for heating, air conditioning, sanitary and building technology, e.g. for door and window handles or for radiator-bleeding
- > With bit insert: slot 1.0 x 7 mm and cross recess PH2
- > With adapter for 1/4" bits chained to key
- > Additional bit adapter for 1/4" bits inside one profile
- > Total length: 90 mm
- > Zinc die-casted



00 11 04

Article No.	EAN 4003773-	↔ mm	⊖ Ø mm	⊖ Ø mm	⊖ Ø mm	⚖ g
00 11 04	048954	90	5 / 7 / 8	9 - 10	6 / 7 / 8 / 9	86

Universal Key

for all standard cabinets and shut-off systems

- > For locking systems in electrical engineering, the supply of gas and water, air conditioning and ventilation systems, industry, technical installations in buildings, etc.
- > 9 different die-cast zinc key-profiles in 1 tool
- > With detachable chain and snap hook
- > Total length: 90 mm
- > Zinc die-casted



00 11 06

Article No.	EAN 4003773-	↔ mm	⊖ Ø mm	⊖ Ø mm	⊖ Ø mm	⊖ Ø mm	⚖ g
00 11 06	071334	90	5 / 6 / 7 - 8 / 9 - 10	7 / 8 - 9 / 10 - 11	3 - 5	6	220

Universal Key "Construction"

for all standard cabinets and shut-off systems

- > For locking systems in electrical engineering, the supply of gas and water, air conditioning and ventilation systems, industry, technical installations in buildings, etc.
- > 9 different die-cast zinc key-profiles in 1 tool
- > With detachable chain and snap hook
- > Construction version with plug-in, magnetically held support: catch for locks with profile cylinder hole and male square in steps
- > With bit adapter for 1/4" bits with magnet
- > Total length: 157 / 95 mm
- > Zinc die-casted



00 11 06 V01

Article No.	EAN 4003773-	↔ mm	⊖ Ø mm	⊖ Ø mm	⊖ Ø mm	⊖ Ø mm	⚖ g
00 11 06 V01	075394	90	5 / 6 / 7 - 8 / 9 - 10	7 / 8 - 9 / 10 - 11	3 - 5	6	255





Control Cabinet Key "DoubleJoint"

- > For locking systems in electrical engineering, the supply of gas and water, air conditioning and ventilation systems, industry, technical installations in buildings, etc.
- > With bit adapter for 1/4" bits with magnet
- > Four different zinc die-cast key profiles in a single key
- > Total length: 97 mm
- > Plastic body, varnished

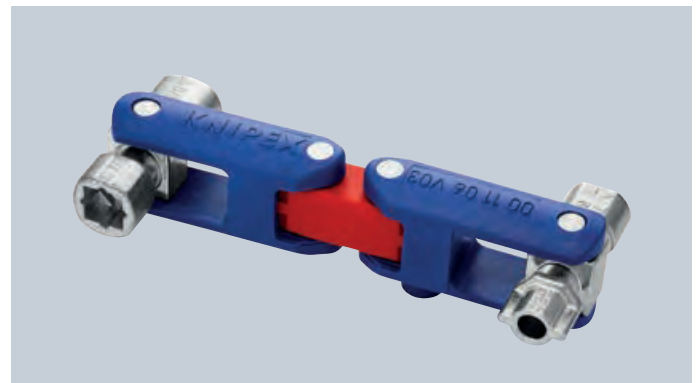
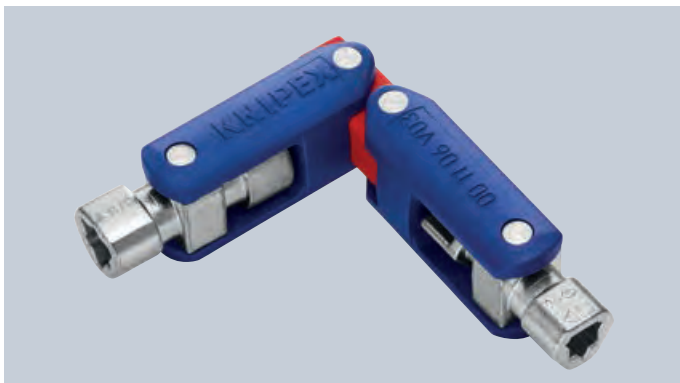

00 11 06 V03



Article No.	EAN 4003773-	↔ mm	 Ø mm	 Ø mm	 Ø mm	 g
00 11 06 V03	083085	62	5 - 8	5 / 7 - 9	3 - 5	107

Pen-Style Control Cabinet Key

for all standard cabinets and shut-off systems

- > Easy to carry pen-style control cabinet key with fastening clip
- > Four different key profiles can be utilised by swivelling the key holder
- > For control cabinets and shut-off systems in the supply of gas, water and electricity
- > For technical installations in buildings, e.g. air conditioning and ventilation systems, shut-off valves, mains switchboards, etc.
- > Universal 1/4" bit adapter for standard bits (permanent magnet for retaining)
- > Additional bit adapter for 1/4" bits inside one key profile
- > With 2 reversible bits: cross recess PH / slot 7.0 x 1.2 mm and TX20 / TX25
- > Tool body: plastic, fibreglass-reinforced
- > Key profiles: zinc die-casted



00 11 07



Article No.	EAN 4003773-	↔ mm	 Ø mm	 Ø mm	 Ø mm	 g
00 11 07	063018	145	5 / 6 / 8	9	3 - 5	95

Cable and Wire Rope Shears



KNIPEX StepCut	149
Cable Shears	150
Cable Shears with twin cutting edge	151
Wire Rope Cutters	152
Electricians Shears	153
ACSR Cable Cutter	155
Cable Cutters (ratchet action)	156
Bowden Cable Cutter	160
Wire Rope and ACSR-Cable Cutters	161

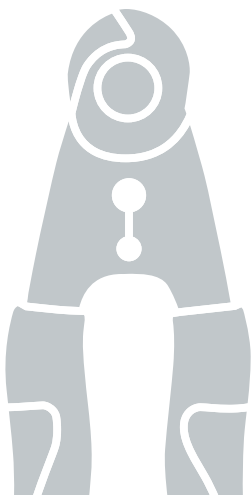

KNIPEX StepCut

Additionally hardened blades, precision-ground:
lighter, cleaner cut without crushing



KNIPEX StepCut

Cable cutting made easy: innovative step cutting separates wires one by one to save energy

- ▶ Small, light, strong: comfortable cutting without crushing and just 160 mm in size
 - ▶ Noticeably less effort: the gradations cut wires one after the other; cutting is up to 40 % easier than with standard cable shears of the same length!
 - ▶ Ergonomic handle design: optimal cutting feel even for larger cable diameters
- > Cuts multi-core stranded copper and aluminium cables up to Ø 15 mm (50 mm²)
 - > Cuts solid copper and aluminium cables up to 5 x 4 mm²
 - > Cuts without crushing
 - > Bolted joint: precise, effortless, durable
 - > Pinch guard fitted for safe work
 - > Not suitable for steel wire and hard drawn copper conductors
 - > Long lifetime: high-grade special tool steel, forged, oil-hardened, cutting additionally induction-hardened



95 11 160



95 12 160

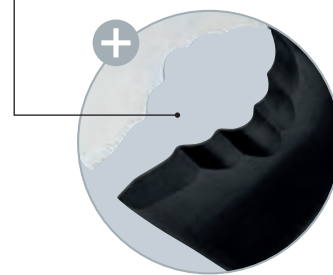

95 16 160



Article No.	EAN 4003773-	↔ mm	Tool	Handles	Cutting capacities			△ g
					⊕ Ø mm	⊕ mm ²	AWG	
95 11 160	085904	165	burnished	plastic coated	15.0	50	1 / 0	180
95 11 160 SB	085911	165	burnished	plastic coated	15.0	50	1 / 0	205
95 12 160	085928	165	burnished	with multi-component grips	15.0	50	1 / 0	220
95 12 160 SB	085935	165	burnished	with multi-component grips	15.0	50	1 / 0	245
95 16 160	085966	165	⚡ 1000V	insulated with multi-component grips, VDE-tested	15.0	50	1 / 0	225
95 16 160 SB	085898	165	⚡ 1000V	insulated with multi-component grips, VDE-tested	15.0	50	1 / 0	250

Cable Shears

- > For cutting copper and aluminium single conductors as well as multiple stranded cables
- > Clean and smooth cut without crushing and deformation
- > Not suitable for steel wire and hard drawn copper conductors
- > Precision-ground, hardened blades
- > Easy cutting with one-hand operation
- > With guard
- > Adjustable bolted joint, self-retaining screw
- > High-grade special tool steel, forged, oil-hardened

Style 2

- > Internal opening spring, protected and captive

Style 4

- > Multifunctional tool for working on NYM cable from 3 x 1.5 mm² to 5 x 2.5 mm² (cutting and stripping); universal stripping area for both solid conductor cross-sections; reliable alignment of the cable in the stripping area due to V-shaped blade geometry

95 12 165 T / 95 16 165 T*

- > Pliers with tether attachment point for mounting a fall protection



Cut performed with a Cable Shear: easy, clean cut without any deformation of the cable



95 26 165: Catch locks shears to the opening spring inside



95 41 165: with stripping function



95 11 165



95 12 165



95 12 165 T



95 16 165



95 21 165



95 22 165

Article No.	EAN 4003773-	↔ mm		Style	Tool	Handles	Cutting capacities			⚖ g
							Ø mm	mm ²	AWG	
95 11 165	040323	165		1	burnished	plastic coated	15	50	1 / 0	215
95 12 165	029182	165		1	burnished	with multi-component grips	15	50	1 / 0	250
95 12 165 T	080190	165		1	burnished	with multi-component grips and integrated tether attachment point	15	50	1 / 0	255
95 16 165	039648	165	⚡ 1000V	1	chrome plated	insulated with multi-component grips, VDE-tested	15	50	1 / 0	262
95 16 165 T	081524	165	⚡ 1000V	1	chrome plated	insulated with multi-component grips with integrated insulated tether attachment point, VDE tested	15	50	1 / 0	260
95 21 165	069805	165	⚡	2	burnished	plastic coated	15	50	1 / 0	215
95 22 165	069812	165	⚡	2	burnished	with multi-component grips	15	50	1 / 0	254
95 26 165	069980	165	⚡ 1000V	2	chrome plated	insulated with multi-component grips, VDE-tested	15	50	1 / 0	275
95 41 165	078609	165	⚡	4	burnished	plastic coated	12	35	1 / 0	220

Cable Shears

with twin cutting edge

- > For cutting copper and aluminium cables
- > Not suitable for steel wire and hard drawn copper conductors
- > Precision-ground, hardened blades
- > Clean and smooth cut without crushing and deformation
- > By dividing the cutting actions into initial cut (insulating sheath in the front cutting area) and final cut (conductor in the back cutting area), cables up to Ø 20 mm can be cut in one-hand operation
- > Low handforce required due to favourable lever ratio and special blade geometry
- > Pinch guard prevents operators' fingers being pinched
- > Adjustable bolted joint, self-retaining screw
- > High-grade special tool steel, forged, oil-hardened



Initial cut: using the front cutting edge to cut the insulating sheath on larger cable diameters leaves an ergonomic handle opening width.



Final cut: after cutting the sheath in the front profile the conductors in the rear part are cut. Initial cut in the front profile, final cut in the rear profile - to keep it as easy as possible.



95 11 200



95 12 200



95 16 200



95 17 200

The twin cutting edge allows a comfortable handle position in all cutting situations within the specified cutting capacity.

Article No.	EAN 4003773-	↔ mm		Tool	Handles	Cutting capacities			⚖ g
						⊕ Ø mm	⊕ mm ²	AWG	
95 11 200	043928	200	(PATENTED)	burnished	plastic coated	20	70	2 / 0	283
95 12 200	047834	200	(PATENTED)	burnished	with multi-component grips	20	70	2 / 0	324
95 16 200	026761	200	⚡ 1000V ⚡ (PATENTED)	chrome plated	insulated with multi-component grips, VDE-tested	20	70	2 / 0	340
95 17 200	026952	200	⚡ 1000V ⚡ (PATENTED)	chrome plated	with dipped insulation, VDE-tested	20	70	2 / 0	360

Wire Rope Cutters

also for high-strength wire rope

- > Compact, light and powerful
- > Up to 30% less physical effort compared to wire rope cutters of the same length
- > Double-mounted box joint design for high level of stability
- > Cutting edges additionally induction-hardened, cutting edge hardness approx. 64 HRC
- > Convenient work thanks to opening spring
- > Secured by locking device during transport
- > Ball bearing steel

95 62 160

- > For wire rope with \varnothing 4.00 / 1960 Nmm²

95 62 160 TC

- > Specially optimised for precise cutting of tyre cord, wire ropes up to \varnothing 2 mm and cables up to \varnothing 2 mm; Ergonomic efficiency thanks to lightweight design and practical opening restriction



95 62 160



95 62 160 TC



Double-bearing joint



For cutting high-strength wire ropes (1960 N/mm²) with a diameter of up to 4 mm



Compact at 160 mm but nevertheless more powerful than many larger wire rope cutters



Article No.	EAN	↔ mm	Head	Handles	Cutting capacities		⚖ g	
					⊕ Ø mm	⊗ mm ²		
95 62 160	082354	160	MM	burnished	with multi-component grips	6.0	4.0	175
95 62 160 TC	082422	160	MM	burnished	with multi-component grips	2.0	2.0	175

Cable Shears

handles extrusion plastic-coated

- > Not suitable for steel wire and hard drawn copper conductors
- > Precision-ground, hardened blades
- > No crushing, slight deformation of the cable only
- > Pinch guard prevents operators' fingers being pinched
- > Adjustable bolted joint
- > Shears body: surgical steel, stainless, vacuum-hardened
- > Handles: plastic, impact-proof

95 05 165

- > Cuts cables up to 10 mm dia. / 24 mm²; with opening spring and locking device; blades made of stainless steel; oil-hardened and tempered

95 06 230

- > For copper single conductors up to 16 mm², multiple stranded wires up to 50 mm², fine stranded up to 70 mm² and aluminium conductors multiple stranded wires up to 70 mm²; easy cutting with one-hand operation due to high transmission ratio; stainless – special grade – steel, oil-hardened and tempered



95 05 165



95 06 230

Article No.	EAN 4003773-	↔ mm	Head	Handles	Cutting capacities			⚖ g
					⊘ mm	mm ²	AWG	
95 05 165	019596	165	polished	plastic coated	10	24	3	111
95 06 230	006305	230	⚡ 1000V	plastic insulated, VDE-tested	16	50	1 / 0	274

Electricians' Shears

- ▶ Precisely ground blades with fine serration for a clean, non-slip cut
- ▶ Cutting edge with integrated cable cutter
- ▶ With plastic belt pouch

- > Universal shears for electricians
- > Handles with multi-component grips, fibreglass-reinforced
- > Cutting edges made from stainless steel, hardness of cutting edges 56 HRC



95 05 10 SB



95 05 155 SB



No slipping thanks to micro-serration



Integrated cable cutter



95 05 10 SB: Fast, easy crimping



Safely stored and ready to hand at all times

Article No.	EAN 4003773-	↔ mm	⚖ g
95 05 10 SB	082125	160	135
95 05 155 SB	077725	155	170

Cable Shears

for two-handed use, short construction

- ▶ Short design, length only 500 mm
- ▶ Low weight, high leverage
- > For cutting copper and aluminium single conductors as well as multiple stranded cables
- > Not suitable for steel wire and wire ropes
- > Precision-ground, hardened blades
- > Clean and smooth cut without crushing and deformation
- > Low handforce required due to favourable lever ratio and special blade geometry
- > Pinch guard prevents operators' fingers being pinched
- > Adjustable bolted joint
- > Cutter head: vanadium electric steel, forged, oil-hardened
- > Handles: aluminium tube, high-strength



Large cutting capacity: max. 27 mm dia. / 150 mm²



95 12 500



95 17 500

Article No.	EAN 4003773-	↔ mm	Head	Handles	Cutting capacities			
					Ø mm	mm ²	AWG	⚖ g
95 12 500	069966	500	burnished	with multi-component grips	27	150	5 / 0	1090
95 17 500	026785	500	polished	with dipped insulation, VDE-tested	27	150	5 / 0	1477

Cable Shears

for two-hand operation

- > For cutting copper and aluminium single conductors as well as multiple stranded cables
- > Not suitable for steel wire and wire ropes
- > Precision-ground, hardened blades
- > Clean and smooth cut without crushing and deformation
- > Favourable lever ratio due to toggle lever
- > Pinch guard prevents operators' fingers being pinched
- > Adjustable bolted joint
- > Bolted cutter head, replaceable
- > Handles: steel tube
- > Cutter head: high-grade chrome vanadium electric steel, forged, oil-hardened



95 21 600



95 27 600

Article No.	EAN 4003773-	↔ mm	Head	Handles	Cutting capacities			
					Ø mm	mm ²	AWG	⚖ g
95 21 600	025252	600	polished	with plastic grips	27	150	5 / 0	1862
95 27 600	021797	600	polished	with dipped insulation, VDE-tested	27	150	5 / 0	2262
95 29 600	021803	Spare cutter head for 95 21 600 / 95 27 600						

ACSR Cable Cutter

(ratchet action)

for cables with a steel core

- ▶ Handy. Compact. Sturdy.
- ▶ Extremely robust design.

- > Cuts through aluminium conductor cable with steel core up to a diameter of 32 mm in one or two-handed operation
- > Cutters with precision cut and induction-hardened cutting edge
- > Two-stage ratchet drive for easy cutting
- > Less physical effort due to very high transmission ratio
- > Fixed handle with support area for putting down the pliers when cutting
- > Locking mechanism for transporting with safely closed handles
- > Special high grade tool steel, multi stage oil-hardened



95 32 340 SR



Enormous power with a weight of just 1300 g



The strong "flange" on the handle can be used as a practical support surface when cutting larger diameters

Article No.	EAN 4003773-	↔ mm		Handles	Ø mm	Ø inch	MCM	⚖ g
95 32 340 SR	081241	340	MM	with multi-component grips	32	1	477	1310
95 39 340 01	081340	Pivot cutter repair kit for 95 32 340 SR						



Cable Cutters

(ratchet action)

- > For cutting copper and aluminium single conductors as well as multiple stranded cables
- > Not suitable for steel wire and wire ropes
- > Precision-ground, hardened blades
- > Clean and smooth cut without crushing and deformation
- > One-hand operation using ratchet principle
- > Little handforce required due to very high transmission ratio
- > Two-stage ratchet drive for easy cutting
- > Simple handling as a result of low weight and compact design – can be used even in confined areas
- > Pinch guard prevents operators' fingers being pinched
- > High-grade special tool steel, forged, oil-hardened

95 31 280 / 95 36 280

- > Suitable for aluminium sector cable up to 4 x 150 mm²

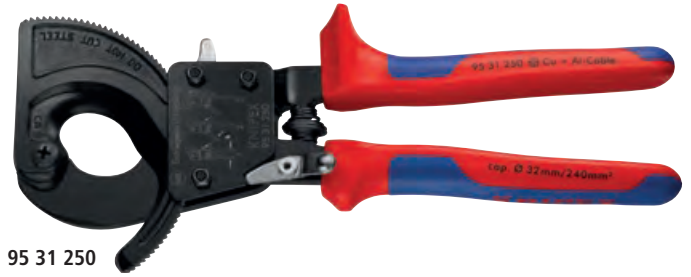

95 31 250



95 31 280



Ratchet principle and two-stage ratchet drive for easier cutting



95 31 280: Large cutting capacity: maximum 52 mm dia. / 380 mm²

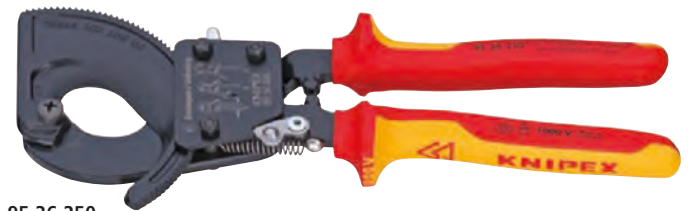

95 36 250



95 36 280



95 31 250/280: fixed handle with support area as an aid to position the cutters on a flat surface

Article No.	EAN 4003773-	↔ mm	MM	Tool	Handles	Cutting capacities			⚖ g
						⊕ Ø mm	⊕ mm ²	MCM	
95 31 250	043935	250	MM	black lacquered	with multi-component grips	32	240	500	676
95 31 280	043942	280	MM	black lacquered	with multi-component grips	52	380	750	860
95 36 250	026884	250	⚡ 1000 V ⚡ MCM	black lacquered	insulated with multi-component grips, VDE-tested	32	240	500	652
95 36 280	026891	280	⚡ 1000 V ⚡ MCM	black lacquered	insulated with multi-component grips, VDE-tested	52	380	750	835
95 39 04	039167	Feed pawl 95 3 250/280							
95 39 250	022244	Movable spare blade for 95 31 250 / 95 36 250							
95 39 08	039204	Barrel spring for 95 31 250/280							
95 39 280	025283	Movable spare blade for 95 31 280 / 95 36 280							
95 39 08 S	039211	Tension spring set for lateral mounting 95 36 25/28							

Cable Cutters

(ratchet principle, 3-stage)

- ▶ Sturdy. Easy to use. Stable.
 - ▶ Innovative ratchet-drive.
 - ▶ For cable up to 60 mm diameter.
- > Fixed handle with support area for putting down the pliers when cutting
 - > Easy handling due to low weight (825 g) and compact construction (320 mm length) – also usable in confined areas
 - > Cutting through copper and aluminium cables with diameters of up to 60 mm in one-hand and two-hand operation
 - > Hardened cutting edges, precisely ground, cut smoothly and neatly without crushing
 - > For cutting copper and aluminium single conductors as well as multiple stranded cables (not suitable for steel wire and wire ropes)
 - > Innovative three-stage ratchet-drive with high leverage for easy cutting in one-hand and two-hand operation
 - > High-grade special tool steel, forged, oil-hardened



95 32 320



95 36 320

The innovative three gear drive permits three operating modes

- > Fast working with full lift of handles and one-handed operation when cutting through insulation material
- > Powerfully sliding the sickle knife forward when cutting through the stranded conductor with two hand through use of the central lifting area (handling opening of between 1/3 and 2/3)
- > Powerfully pushing the sickle knife forward with one hand to cut through the stranded conductor through use of the first third of the handle lift with one or two hands

First manual ratchet-action cable cutter for one-hand and two-hand operation for cutting copper and aluminium cables with diameters of up to 60 mm!



Article No.	EAN 4003773-	↔ mm		Tool	Head	Handles	Cutting capacities			
							Ø mm	mm ²	MCM	Δg
95 32 320	075172	320	⚡	black atramentized	polished	with multi-component grips	60	600	1200	825
95 36 320	075189	320	⚡ 1000V ⚡	black atramentized	polished	insulated with multi-component grips, VDE-tested	60	600	1200	830
95 39 320 01	075714	Pivot cutter repair kit for 95 32 320 and 95 36 320								
95 39 320 02	075721	Fixed cutter repair kit for 95 32 320 and 95 36 320								

Cable Cutters

(ratchet action)

for steel wire armoured cables (SWA cable)

- ▶ Cuts through steel wire armoured cables with a diameter of up to 45 mm / 380 mm² (e.g. 4 x 95 mm²) using one or two-handed operation
- ▶ Sturdy. Easy to use. Stable.
- > Simple handling due to low weight (800 g) and compact design (315 mm length) – can also be used in confined areas
- > Precision-ground blades and induction-hardened cutting edges cut smoothly and neatly without crushing
- > Innovative high leverage three-stage ratchet-drive
- > Support area for putting down the pliers when cutting
- > Not suitable for cutting ACSR cable and wire rope!
- > Cutter head: special high-grade tool steel, forged, oil-hardened



95 32 315 A



95 36 315 A



Precision-milled and induction-hardened cutting edge

Article No.	EAN 4003773-	↔ mm	Tool	Handles	Cutting capacities			⚖ g	
					Ø mm	mm ²	MCM		
95 32 315 A	078562	315	MM	black lacquered	with multi-component grips	45	380	750	800
95 36 315 A	078579	315	⚠ 1000 V ⚡ MM	black lacquered	insulated with multi-component grips, VDE-tested	45	380	750	800
95 39 315 A01	078586	Pivot cutter repair kit for 95 32 315 A and 95 36 315 A							

Cable Shears

(ratchet action)

with telescopic handles

- ▶ Cable shears with adjustable telescopic handles allowing angular positioning
- > For cable diameters up to 38 mm, handles can be positioned at an angle to set the optimum handle width, which makes the shear also suitable for work in confined areas
- > Comfortable work thanks to ratchet action and low weight
- > Heavy duty telescopic handles made of oval aluminium tubing; extendable up to 770 mm for maximum leverage on large cable diameters; retractable down to 570 mm for minimum space requirements during transport
- > Replaceable cutting head
- > Extensive cutting range up to max. Ø 38 mm or max. 280 mm² (e.g. 4 x 70 mm² NYY) in copper and aluminium cables
- > Easier, neater cut due to optimised cutting edge geometry
- > Adjustable bolted joint
- > Handles: high-strength oval aluminium tubing
- > Cutting head: special quality high-grade tool steel, oil-hardened



95 32 038



Handles adjustable in length and angular position for easier work: set the handle length to the optimum lever for powerful cutting; put the handles at an angle for a comfortable gripping position

Article No.	EAN 4003773-	↔ mm	Head	Handles	Cutting capacities			⚖ g
					Ø mm	mm ²	MCM	
95 32 038	071556	570	burnished	with multi-component grips	38	280	550	1980
95 39 038	073260	Spare cutter head for 95 32 038						

Cable Cutters

(ratchet action)

with telescopic handles

- > For copper and aluminium single conductors as well as multiple stranded cables – also with hard rubber or plastic sheath
- > Not suitable for steel wire and wire ropes
- > Also suitable for cables with iron sheath reinforcement
- > Little hand force required for cutting due to optimum transmission ratio
- > High cutting capacity due to two-hand operation and ratchet action
- > The blade can be opened in any cutting position
- > Handle length with multiple position adjustment from 400 - 610 mm (short transport length, individual adaptation to working conditions)
- > Blade: special-quality high-grade tool steel, oil-hardened
- > Handles: high-strength oval aluminium tubing

95 32 100

- > Tool length: 650 - 860 mm; weight only 4980 g

95 32 060

- > Tool in length: 630 to 830 mm; weight only approx. 3820 g



95 32 060



Article No.	EAN 4003773-	↔ mm	Head	Handles	Cutting capacities			⚖ g
					Ø mm	mm ²	MCM	
95 32 060	071563	630	burnished	with multi-component grips	60	740	1400	3820
95 32 100	071570	680			100	960	1900	4980
95 39 720	025290	Movable spare blade for 95 31 720 / 95 32 060						
95 39 870	025306	Movable spare blade for 95 31 870 / 95 32 100						

Wire Rope Cutters

forged

Double function: neat cutting, precise crimping

- > With two crimping dies for end caps on Bowden cable sheaths and end ferrules for traction cables
- > Comfortable work thanks to handy, slim design and internal opening spring
- > Bolted joint for precise blade guidance, re-adjustable
- > High leverage for reduced effort
- > Cutting edge hardness approx. 64 HRC
- > Chrome vanadium heavy-duty steel, forged, multi stage oil-hardened

95 62 190 T*

- > Pliers with tether attachment point for mounting a fall protection



95 61 190



95 62 190



95 62 190 T

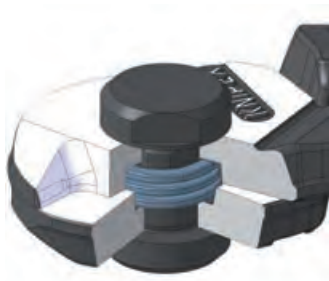

Internal opening spring



Crimping of the end caps on the Bowden cable sheath

Cuts all wire ropes without splaying, including those that are extremely strong

Article No.	EAN 4003773-	↔ mm		Head	Handles	Cutting capacities				⚖ g
						⊕ Ø mm	⊗ Ø mm	◐ Ø mm	● Ø mm	
95 61 190	040651	190	⌵	polished	plastic coated	7.0	5.0	4.0	2.5	310
95 62 190	071976	190	⌵	burnished	with multi-component grips	7.0	5.0	4.0	2.5	314
95 62 190 T	080206	190	⌵	burnished	with multi-component grips and integrated tether attachment point	7.0	5.0	4.0	2.5	345

Bowden Cable Cutter

- > For Bowden cables and soft wire rope up to 3.0 mm dia. (also V2A)
- > Smooth and clean cutting due to special shape of the cutting edges
- > Sickle shape cutting edges surround the material and prevent the wire rope fanning out
- > Little handforce required due to very high transmission ratio
- > With opening spring and locking device
- > Chrome vanadium heavy-duty steel, forged, multi stage oil-hardened



95 61 150



Article No.	EAN 4003773-	↔ mm		Shears	Head	Handles	Cutting capacities		⚖ g
							⊗ Ø mm		
95 61 150	065197	150	⌵	black atramentized	polished	plastic coated	3.0		205

Wire Rope and ACSR-Cable Cutters

Handles: aluminium, high-strength

- > For wire ropes and steel rods, copper and aluminium cables
- > Suitable for cutting overhead cables with strain relief wire (ACSR-cables)
- > Angular cutting blades allow cutting of single rope wire
- > Optimum transmission ratio for high cutting performance
- > Bolted cutter head, replaceable
- > Low weight
- > Handles: aluminium, high-strength
- > Cutter head: high-grade special tool steel, multi stage oil-hardened

95 81 600

- > With reinforced cutter head for higher performance, also cuts piano wire



95 71 445



95 71 600



95 77 600



95 81 600

Article No.	EAN 4003773-	↔ mm		Head	Handles	Cutting capacities				AWG	⚖ g
						mm ²	Ø mm	Ø mm	Ø mm		
95 71 445	014522	445		polished	plastic coated	95	10,0	7,0		3 / 0	1083
95 71 600	014539	600		polished	plastic coated	150	14,0	9,0		5 / 0	1716
95 77 600	025313	600	⚡ 1000V ⚠	polished	dipped insulation	150	14,0	9,0		5 / 0	2359
95 81 600	025344	600		polished	plastic coated	150	16,0	10,0	4,5	5 / 0	2256
95 79 445	025320	Spare cutter head for 95 71 445									
95 79 600	025337	Spare cutter head for 95 71 600 / 95 77 600									
95 89 600	025351	Spare cutter head for 95 81 600									

Crimping Pliers and Crimp Assortments

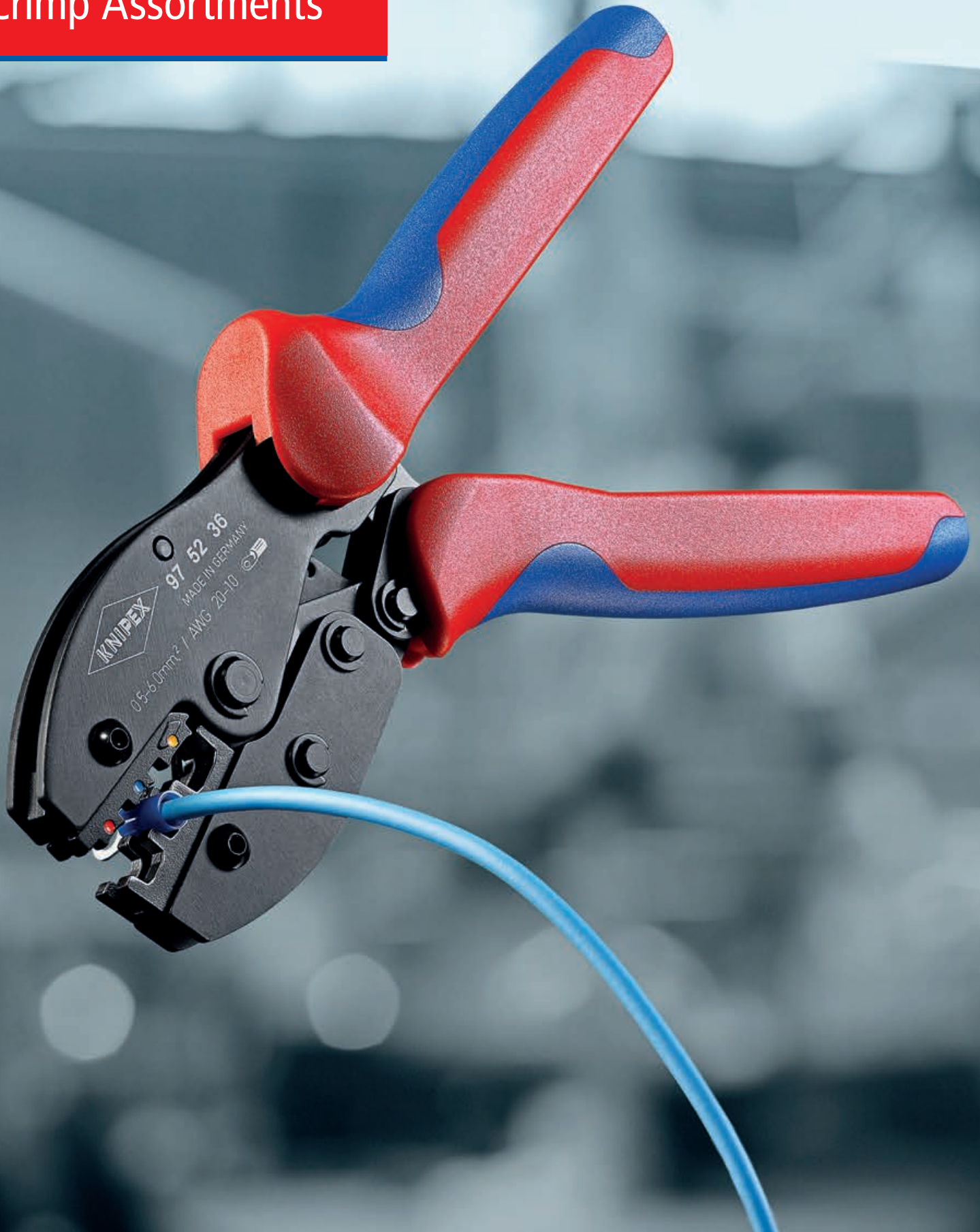

Crimping Pliers	164
Insertion tool	165
KNIPEX MultiCrimp® – Crimping Pliers with changer magazine	166
Crimp System Pliers	168
KNIPEX eCrimp – Electromechanical Crimp System Pliers	169
Crimping Dies	170
Locators	171
Tool Case for Photovoltaics	172
Set of Mounting Tools for solar cable connectors MC4 (Multi-Contact)	173
Compression Tool	173
Crimping Pliers for Scotchlok™ connectors	173
Crimping Pliers for Western plugs	174
Crimping Pliers short design	174
Crimping Pliers also for two-hand operation	175
KNIPEX PreciForce® – Crimping Pliers	176
Four-Mandrel Crimping Pliers for turned contacts	178
Self-Adjusting Crimping Pliers for wire ferrules with lateral access	180
KNIPEX Twistor16® – Self-Adjusting Crimping Pliers for wire ferrules	181
Self-Adjusting Crimping Pliers for wire ferrules with front loading	182
Crimping Pliers for micro plugs	183
Crimping Pliers for wire ferrules	183
Crimp Assortments	186
Assortment Boxes	192
F-compression connector	193



Crimping Pliers

- > For cutting cables, stripping wire and crimping insulated and non-insulated terminals, connectors and plug type connectors
- > With threaded holes for cutting copper and brass screws threaded M 2.6 / M 3 / M 3.5 / M 4 and M 5
- > Bolted joint for higher stability and even movement
- > Special steel, high-strength



97 21 215



97 21 215 B



97 21 215 C



97 22 240

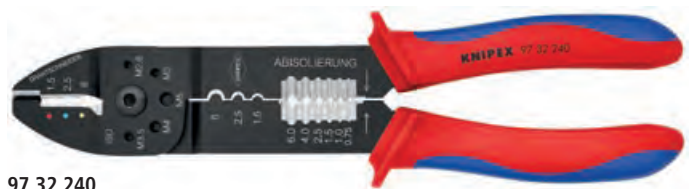

97 32 240

Article No.	EAN	↔ mm			Pliers	Handles	Applications	Capacity mm ²	AWG	△ g
97 21 215	019688	230			black lacquered	with multi-component grips	insulated terminals + cable connectors	0.5 - 6	20 - 10	290
97 21 215 B	019695	230			black lacquered	with multi-component grips	non-insulated open plug-type connectors (plug width 6.3 mm)	0.5 - 2.5	20 - 13	290
97 21 215 C	019701	230			black lacquered	with multi-component grips	non-insulated terminals + cable connectors	0.5 - 6	20 - 10	290
97 22 240	070726	240			black lacquered	with multi-component grips	insulated terminals + cable connectors/ non-insulated open plug-type connectors (plug width 6.3 mm)	0.5 - 6	20 - 10	270
							non-insulated open plug-type connectors (plug width 6.3 mm)	0.5 - 2.5	20 - 13	
97 32 240	079491	240			black lacquered	with multi-component grips	insulated terminals + cable connectors/ non-insulated terminals + cable connectors	0.5 - 6	20 - 10	300
							non-insulated terminals + cable connectors	0.5 - 6	20 - 10	

Insertion tool

for LSA-Plus and identical construction design

- > Tool for putting on boards, sockets and fields
- > Pushing down and cutting in one operation
- > For UTP and STP cables, conductor 0.4 - 0.8 mm dia.
- > With integrated pulling hook and release blade
- > Housing: plastic, impact-proof



97 40 10



With integrated pulling hook



Inserts and cuts cables in one operation

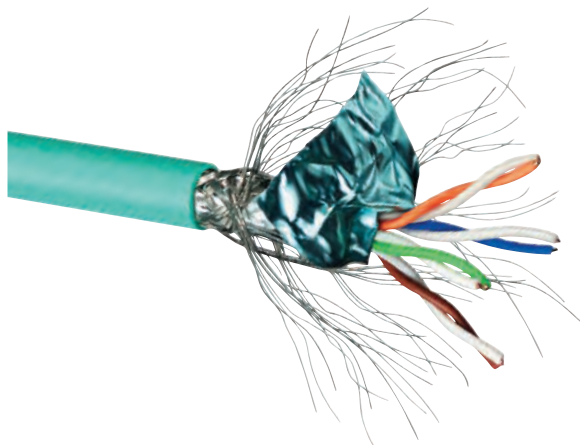

Article No.	EAN 4003773-	↔ mm	Head	Applications	Capacity Ø mm	⚖ g
97 40 10	044895	175	burnished	UTP- and STP-cables, LSA-Plus and identical	0.4 - 0.8	100



KNIPEX MultiCrimp®

Crimping Pliers with changer magazine

- > Just one tool for the most common crimping applications
- > Crimping dies changed quickly and easily without any additional tool
- > Sorted and protected storage of the interchangeable dies in a round magazine
- > Comfortable, powerful crimping pliers in professional quality
- > Same reliable crimping results as with fixed crimping dies
- > Consistently high crimping quality thanks to precision dies and forced locking mechanism (unlockable)
- > Chrome vanadium electric steel in special quality, oil-hardened
- > Round magazine: plastic, fibreglass-reinforced

97 33 01

- > Crimping pliers with round magazine and three interchangeable crimping dies for non-insulated open plug type connectors (4.8 + 6.3 mm width) from 0.5 - 6.0 mm²; for insulated terminals, plug connectors and butt connectors from 0.5 - 6.0 mm² and for insulated and non-insulated wire end sleeves from 0.25 - 6.0 mm²

97 33 02

- > Crimping pliers with round magazine and five interchangeable dies for non-insulated open plug type connectors (plug width 4.8 + 6.3 mm) from 0.5 - 6 mm²; for insulated terminals, plug connectors and butt connectors from 0.5 - 6 mm²; for insulated and non-insulated end sleeves (ferrules) from 0.25 - 6 mm²; for insulated and non-insulated wire end sleeves with 10 / 16 / 25 mm² and for non-insulated crimp terminals, tube and compression cable lugs in accordance with DIN 46234 and DIN 46235 and non-insulated crimp, butt and press connectors in accordance with DIN 46341 and DIN 46267



97 33 01



97 33 02

Compact, inexpensive and light-weight crimping pliers for fitting and repairs. The electrician needs only one tool now instead of five as before.



Changing position: service lever opens out for parallel jaw positioning



Changing the crimping dies: unlock the magazine position, take out the set of dies which the pliers have been pushed on



Fold in the service lever and press the pliers – ready for use again



Magazine for crimping dies can be carried on a belt



Clearly visible marking on the crimping dies with pictograms

Article No.	EAN 4003773-	↔ mm			Applications	Capacity mm ²	AWG	⚖ g
97 33 01	066927	250			non-insulated open plug type connectors (plug width 4.8 + 6.3 mm)	0.5 - 6	20 - 10	770
					insulated terminals, plug connectors + butt connectors	0.5 - 6	20 - 10	
					Wire ferrules	0.25 - 6	23 - 10	
97 33 02	066934	250			non-insulated open plug type connectors (plug width 4.8 + 6.3 mm)	0.5 - 6	20 - 10	870
					insulated terminals, plug connectors + butt connectors	0.5 - 6	20 - 10	
					Wire ferrules	0.5 - 6 10 / 16 / 25	23 - 10 7 / 5 / 3	
					non-insulated crimp terminals, tube and compression cable lugs in accordance with DIN 46234 and DIN 46235 and non-insulated crimp, butt and press connectors in accordance with DIN 46341 and DIN 46267	0.5 - 10	20 - 7	

97 39 05	070078	Crimping dies for non-insulated open plug type connectors (plug width 4.8 + 6.3 mm)						
97 39 09	077763	Crimping dies for insulated and non-insulated wire ferrules						
97 39 13 A	077770	Crimping dies for non-insulated crimp terminals, tube and compression cable lugs in accordance with DIN 46234 and DIN 46235 and non-insulated crimp, butt and press connectors in accordance with DIN 46341 and DIN 46267						
97 39 06	070085	Crimping dies for insulated terminals, plug connectors and butt connectors						
97 39 08	070092	Crimping dies for insulated and non-insulated wire ferrules						
97 39 13	070108	Crimping dies for non-insulated crimp terminals, tube and compression cable lugs in accordance with DIN 46234 and DIN 46235 and non-insulated crimp, butt and press connectors in accordance with DIN 46341 and DIN 46267						
97 39 90	070061	Changer magazine empty						

Crimp System Pliers

for exchangeable crimping dies

- > Just one tool for almost 1000 crimping applications
- > Almost parallel crimping motion
- > Consistently high crimping quality thanks to precision dies and forced locking mechanism (unlockable)
- > Crimping pressure has been set precisely (calibrated) in the factory, re-adjustable
- > Optimum transmission of force due to lever action for fatigue-reduced operation
- > Ergonomically designed handles
- > Different locators for precise positioning of the connectors
- > Crimping dies for applications not covered in the range offered here, may be available on request
- > Chrome vanadium electric steel in special quality, oil-hardened

97 43 05

- > With attached crimping dies for non-insulated open plug-type connectors (4.8 and 6.3 mm connector width)

97 43 06

- > With attached crimping dies for insulated terminals and plug connectors

97 43 200

- > Comes in a plastic case; foam insert with recesses for crimping dies and locators; with service tool (Allen key), screws and nuts; without crimping dies

97 43 200 A

- > Pliers without crimping dies, without case



97 43 200



97 43 200 A



97 43 05



97 43 06

With the possibility of crimping almost all currently available crimping connections with just one tool and state-of-the-art crimping pliers technology, the crimp system pliers solves almost all tasks in mobile and stationary crimping technology and is an excellent tool for professionals to use for standard crimping.



97 43 200 with crimping dies 97 49 06 for insulated terminals, plug connectors and butt connectors



97 43 200 with crimping dies 97 49 09 for wire ferrules



97 43 400 with crimping dies 97 49 24 and locator 97 49 93 for D-Sub plugs

Article No.	EAN	↔ mm		Pliers	Handles	Applications	Capacity mm ²	AWG	Δ g
97 43 200	030812	200		MM	burnished with multi-component grips	see crimping dies table			988
97 43 200 A	071587	200		MM	burnished with multi-component grips	see crimping dies table			574
97 43 05	031031	200		MM	burnished with multi-component grips	Crimp System Pliers for non-insulated open plug-type connectors (4.8 and 6.3 mm connector width)	0.5 - 6	20 - 10	618
97 43 06	031048	200		MM	burnished with multi-component grips	Crimp System Pliers for insulated terminals and plug connectors	0.5 - 6	20 - 10	610

KNIPEX eCrimp

Electromechanical Crimp System Pliers for exchangeable crimping dies

- > Strong electromechanical drive, no hydraulic components, no leakages
- > Possible use of over 40 KNIPEX crimping dies and locators as well as more than 1000 special crimping dies from the proven Crimp System Pliers (97 43 200)
- > Ergonomically optimised, user-friendly working height during workshop operation
- > LED working light for targeted illumination of the crimping area
- > Low noise level
- > Long servicing intervals (up to 25,000 crimping actions)! The KNIPEX eCrimp is designed to only require servicing after 25,000 crimping actions. This means the intervals between servicing the electromechanical crimping pliers is 2.5 : 1 in relation to conventionally actuated crimping pliers. The pliers are therefore available for crimping use for considerably longer. They do not need to be sent away frequently for servicing. High availability without downtimes while being serviced.
- > Powerful li-ion rechargeable battery (12 V; 1.5 Ah; 18 Wh); charge time approx. 30 min; no memory effect
- > Tether attachment point to prevent falling during field work
- > Max. pressing force of the jaws approx. 11 kN
- > Approx. 170 operating cycles for plug-in connectors with 10 mm² nominal size with a single battery charge

97 43 E

- > With euro plug

97 43 E AUS

- > With plug adapter for AS/NSZ 3112 (AUS+NZ)

97 43 E UK

- > With plug adapter for BS 5733 (GB)

97 43 E US

- > With plug NEMA 1-15P (USA / Canada / Mexico)



97 43 E

The KNIPEX eCrimp is the first electromechanically actuated model of crimping pliers in the world. The possible use of over 40 KNIPEX crimping dies and locators as well as more than 1,000 special crimping dies from the proven Crimp System Pliers (97 43 200). Its universal application range makes it an essential tool in the workshop and for rough field work.



Article No.	EAN	Mains voltage/frequency	Connector socket	g
97 43 E	4003773-076858	230 V / 50 Hz	CEE 7/16	1960
97 43 E UK	076865	230 V / 50 Hz	BS 5733	1960
97 43 E AUS	076872	230 V / 50 Hz	AS/NSZ 3112	1960
97 43 E US	077008	120 V / 60 Hz	NEMA 1-15P	1960

Crimping Dies

for KNIPEX Crimp System Pliers

Art. No.: 97 43 XX

> Up to 250 different die profiles available; special profiles on request

Article No.	EAN 4003773-		Applications	Capacity mm ²	AWG	Capacity SW mm	Sleeves Ø mm
97 49 04	030850		non-insulated open plug type connectors (plug width 2.8 + 4.8 mm)	0.1 - 2.5	27 - 13		
97 49 05	030867		non-insulated open plug type connectors (plug width 4.8 + 6.3 mm)	0.5 - 6	20 - 10		
97 49 06	030836		insulated terminals, plug connectors + butt connectors	0.5 - 6	20 - 10		
97 49 07	077749		heat shrinkable sleeve connectors	0.5 - 6	20 - 10		
97 49 08	030874		insulated and non-insulated wire ferrules	0.25 - 6	23 - 10		
97 49 09	030881		insulated and non-insulated wire ferrules	10 / 16 / 25	7 / 5 / 3		
97 49 10	076896		non-insulated tubular cable lugs and crimp terminals in accordance with DIN 46237 and non-insulated butt and crimp connectors in accordance with DIN 46341	0.25 - 0.75 / 1 - 1.5 / 2.5	13 / 15 - 17 / 19 - 20		
97 49 11	076902		non-insulated crimp terminals, tube and compression cable lugs in accordance with DIN 46234 and DIN 46235 and non-insulated crimp, butt and press connectors in accordance with DIN 46341 and DIN 46267	4 / 6 / 10	11 / 10 / 7		
97 49 14	077756		for non-insulated crimp terminals, tube and compression cable lugs in accordance with DIN 46234 and DIN 46235 and non-insulated crimp, butt and press connectors in accordance with DIN 46341 and DIN 46267	0.5 - 10	20 - 7		
97 49 15	043164		for plug connectors and angled spade connectors according to DIN 46346 Form A (1.5 - 2.5 mm ²) for non-insulated, open lug connectors (straight version) according to DIN 46247 (2.5 - 6 mm ²)	1.25 - 2.5 / 3 - 6			
97 49 16	040675		insulated terminals + cable connectors	10 - 16	7 / 5		
97 49 18	063186		Twin wire ferrules for two flexible conductors	6 / 10 / 16			
97 49 19	030898		insulated and non-insulated wire ferrules	35 - 50	2 / 0		
97 49 20	045069		F-connectors for TV and satellite connections			7.0 / 8.4 / 8.1	7.7 / 9.5 / 9.5
97 49 23	052135		non-insulated terminals + cable connectors	16 / 25	5 / 3		
97 49 24	030911		D Sub; HD 20; HDE plug	0.03 - 0.56	32 - 20		
97 49 25	079798		for crimping connectors from the Micro-Fit™ series from Molex LLC		30 - 26 / 24 - 22 / 20		
97 49 26	079804		for crimping connectors in the Mini-Fit® series from Molex LLC		24 - 20 / 18 / 16		
97 49 27	079811		MQS connectors	0.25 / 0.35 / 0.5	24 / 22 / 20		
97 49 28	083757		connectors of the AMP Superseal 1.5 series from Tyco Electronics	0.35 - 0.5 / 0.75 / 1 / 1.5	32 - 20		
97 49 30	030904		non-insulated crimp connectors in accordance with DIN 46267	1.5 - 4 / 6 / 10	15 - 7 / 10 / 7		
97 49 35	034315		spark plug connectors and distributors	1	17		
97 49 40	030959		Coax connectors RG 58, 59, 62, 71, 223			5.4 / 6.48 / 1.72	6.4 / 7.6 / 2.1

Article No.	EAN 4003773-		Applications	Capacity mm ²	AWG	Capacity SW mm	Sleeves Ø mm
97 49 44	041443		PCB plug connector, type Phoenix-Contact module connector MCC-MT	0.14 / 1.5			
97 49 50	030966		Coax connectors/ car phone RG 58, 74, 188, 316			3.25 / 4.52 / 5.4 / 1.72 / 1.07 / 0.72	3.9 / 5.4 / 6.4 / 2.1 / 1.3 / 0.95
97 49 54	041450		TE Timer Contact System / Junior Power Timer / Receptacle Contacts (length 18.8 mm)	0.5 - 2.5			
97 49 59	073734		solar cable connectors Helios H4 (Amphenol)	2.5 / 4 / 6	13 - 10		
97 49 60	030928		turned contacts (HTS + Harting)	0.14 - 4	26 - 11		
97 49 61	045137		turned contacts	1.5 / 2.5 / 4 / 6	10 / 11 / 13 / 15		
97 49 62	063179		solar cable connectors (Huber + Suhner)	2.5 / 4	13 / 11		
97 49 63	066675		solar cable connectors (Huber + Suhner)	4 / 6	11 / 10		
97 49 64	044055		ABS connectors in motor vehicles	1 / 6	17 - 10		
97 49 65	066682		solar cable connectors MC3 (Multi-Contact)	2.5 - 6	13 / 10		
97 49 66	066699		solar cable connectors MC4 (Multi-Contact)	2.5 - 6	13 / 10		
97 49 66 4	072096		solar cable connectors MC4 (Multi-Contact) cutting – stripping – crimping	4	11		
97 49 66 6	072102		solar cable connectors MC4 (Multi-Contact) cutting – stripping – crimping	6	10		
97 49 67	066705		solar cable connectors (Hirschmann)	2.5 - 6	13 - 10		
97 49 68	066712		solar cable connectors (Tyco)	1.5 - 6	15 - 10		
97 49 69 1	072119		solar cable connectors gesis® solar PST 40 (Wieland)	0.14 - 4	26 - 11		
97 49 69 2	072126		solar cable connectors gesis® solar PST 40 (Wieland)	4 - 10	11 - 7		
97 49 70	030942		solar cable connectors MC4 (Multi-Contact)	4 - 10			
97 49 71	075066		solar cable connectors MC4 (Multi-Contact)	4 - 10	11 - 7		
97 49 72	076957		solar cable connectors MC3 (Multi-Contact)	4 / 6 / 10	7 / 10 / 11		
97 49 74	044062		unshielded Molex plugs				
97 49 76	047513		shielded Stewart plugs				
97 49 81	042778		fibre optic connectors, e.g. Harting			3.0 / 4.95 / 6.5	3.5 / 6.0 / 7.5
97 49 82	042785		fibre optic connectors, e.g. Telegärtner			3.25 / 3.65 / 4.52	3.6 / 4.0 / 5.4
97 49 83	044079		fibre optic connectors, e.g. FSMA-;ST-; SC- + STSC-/K-connectors			3.65 / 4.2 / 5.0	4.3 / 5.4 / 6.0
97 49 84	042792		fibre optic connectors, e.g. Huber/Suhner			3.8 / 4.3 / 4.95	4.5 / 5.2 / 6.0
97 49 87	043331		fibre optic connectors, e.g. FSMA-;ST- and MIC-connectors			8.7	9.5
97 49 94	030997	Locator for 97 49 04					
97 49 95	031000	Locator for 97 49 05					
97 49 93	047926	Locator for 97 49 24 (DSubplugs)					
97 49 28 1	083764	Wire Feed Stopper for 97 49 28					
97 49 59 1	073741	Locator for 97 49 59 (solar cable connectors Helios H4)					
97 49 90	031017	Locator for 97 49 60 (HTS+Harting)					
97 49 65 1	066729	Locator for 97 49 65 (solar cable connectors MC3)					
97 49 66 1	066736	Locator for 97 49 66 (solar cable connectors MC4)					
97 49 68 1	066743	Locator for 97 49 68 (solar cable connectors Solarlok)					
97 49 69 11	072133	Locator for 97 49 69 1 and 97 49 69 2					
97 49 71 1	075073	Locator for 97 49 71 (solar cable connectors MC4)					

Tool Case for Photovoltaics

- > With tools for photovoltaics
- > Without crimping dies – please order separately (see ref. 97 49...) for individual assortment
- > With service tools (hexagonal key) for the change of crimping dies
- > Shock-resistant plastic case
- > Foam insert with recesses for tools, crimping dies and locators
- > Dimensions, exterior (W x H x D):
345 x 80 x 280 mm



97 91 01

Article No.	EAN 4003773-				Quantity	⚖ g
97 91 01	070351			Tool Case for Photovoltaics		1964
	062998	⚡ PATENTED	12 12 11	Precision Insulation Stripper with adapted blades	1	
	039648	⚡ 1000 V ⚡ ⚡ ⚡	95 16 165	Cable Shears	1	
	030812	⚡	97 43 200	Crimp System Pliers for exchangeable crimping dies	1	

Set of Mounting Tools

for solar cable connectors MC4 (Multi-Contact)

- > Set of two mounting tools
- > To loosen and tighten cable glands of MC4 solar plugs
- > To open the locking of MC4 housings (even in case of mounted lock clip)
- > Tool: plastic, fibreglass-reinforced



97 49 66 2

Article No.	EAN 4003773-	↔ mm	⚖ g
97 49 66 2	074106	115	18
97 49 66 1	066736	Locator for 97 49 66 (solar cable connectors MC4)	
97 49 66 4	072096	Crimping dies	
97 49 66 6	072102	Crimping dies	

Compression Tool

for coax connectors

- ▶ For crimping F, BNC and RCA connectors
- ▶ Robust design

- > Suitable for RG 59 / 6 / 11 cable
- > Rotatable head for different cable sizes
- > Rotatable insert for various types of connector
- > Adjusting screw for various connector lengths
- > Applicable among others for compression connectors Kathrein EMK 12; Cablecon F-56 CX3 5.1; Astro FKS 06



97 40 20 SB



Article No.	EAN 4003773-	↔ mm	Applications	⚖ g
97 40 20 SB	077626	175	for F, BNC and RCA connectors	430

Crimping Pliers for Scotchlok™ connectors

with side cutter

- > For crimping plastic-insulated telecommunication or signal cables using the U-contact principle in single Scotchlok™ connectors
- > No stripping necessary, U-shaped elements establish the connection
- > Cutting edges additionally induction-hardened, cutting edge hardness approx. 59 - 62 HRC
- > With opening spring
- > Vanadium electric steel; forged, oil-hardened



97 50 01

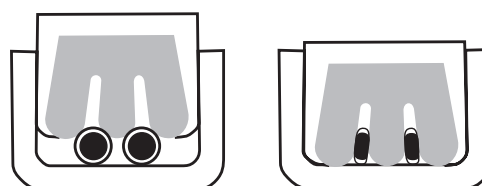

Article No.	EAN 4003773-	↔ mm	Head	Handles	Applications	Capacity Ø mm	⚖ g
97 50 01	028239	155	 M	polished plastic coated	Scotchlok™ single connector	0.4 - 1.1	135

Crimping Pliers for Western plugs

- > Professional tool for cutting and stripping unshielded ribbon telephone cables
- > For crimping 6- and 8-pole Western plugs type RJ 11/12 (9.65 mm width) and type RJ 45 (11.68 mm width)
- > Precise crimping process thanks to parallel crimping
- > Repetitive, high crimping quality due to integral lock (self-releasing mechanism)
- > With length cutter and stripping knife for ribbon cables 6 and 12 mm length
- > With additional stripping device for round cables
- > Optimum transmission of force due to lever action for fatigue-reduced operation
- > For Western plug type RJ 10 (7.65 mm wide), RJ 11/12 (9.65 mm wide) and RJ 45 (11.68 mm wide)
- > Head burnished, two-colour dual component handles
- > Chrome vanadium electric steel in special quality, oil-hardened



97 51 10



97 51 12



Article No.	EAN 4003773-	↔ mm		Handles	Capacity	⚖ g	
97 51 10	043171	190		with multi-component grips	RJ 11/12 (6-poles) 9.65 mm RJ 45 (8-poles) 11.68 mm	340	
97 51 12	043188	200		with multi-component grips	RJ 10 (4-poles) 7.65 mm RJ 11/12 (6-poles) 9.65 mm RJ 45 (8-poles) 11.68 mm	533	
97 59 06	029700	4 spare blades for 97 51 10					
97 59 12	069997	3 spare blades for 97 51 12					

Crimping Pliers

short design

- > Consistently high crimping quality thanks to precision dies and forced locking mechanism (unlockable)
- > Crimping pressure has been set precisely (calibrated) in the factory, re-adjustable
- > Optimum transmission of force thanks to toggle lever for fatigue-reduced operation
- > Good handling due to 20° angled head, low weight and short design
- > Optimum transmission of force due to lever action for fatigue-reduced operation
- > Chrome vanadium electric steel in special quality, oil-hardened

97 52 14

- > Available as accessory: locator for non-insulated open plug-type connectors



97 52 14



97 52 20



Article No.	EAN 4003773-	↔ mm		Handles	Applications	Capacity mm ²	AWG	⚖ g
97 52 14	026808	195		with multi-component grips	non-insulated open plug type connectors (plug width 2.8 + 4.8 mm)	0.1 - 1.5	27 - 16	387
97 52 20	026853	195		with multi-component grips	Coax-, BNC- and TNC-connectors RG 58/59/62/71/223			380
97 59 14	026976	Locator for 97 52 14						

Crimping Pliers

also for two-hand operation

- > For solder-free electrical connections
- > The ingenious lever transmission reduces the handforce up to 30 % compared with regular crimping pliers
- > Consistently high crimping quality thanks to precision dies and forced locking mechanism (unlockable)
- > Crimping pressure has been set precisely (calibrated) in the factory, re-adjustable
- > Two-hand operation for easy crimping of large conductor diameters
- > Easy handling as a result of well balanced centre of gravity, angled head and ergonomically shaped handles
- > Chrome vanadium electric steel in special quality, oil-hardened



First step: move the handle with two fingers only until both jaws touch the connector to be crimped

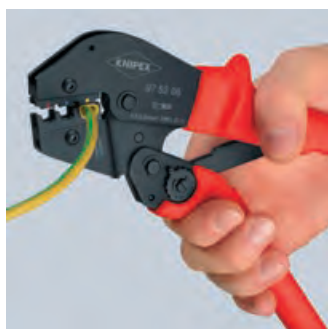

Second step: now use the whole hand for further crimping procedure



Third step: when greater hand force is required, such as e.g. when crimping insulated connectors 6.0 mm², two-hand operation is possible by the longer handles



97 52 04



97 52 05



97 52 06



97 52 08



97 52 09



97 52 10



97 52 13



97 52 19

Article No.	EAN 4003773-	↔ mm			Applications	Capacity mm ²	AWG	Δ g
97 52 04	025450	250			non-insulated open plug type connectors (plug width 2.8 + 4.8 mm)	0,1 - 2,5	27 - 13	562
97 52 05	025467	250			non-insulated open plug type connectors (plug width 2.8 + 4.8 mm)	0,5 - 6	20 - 10	572
97 52 06	025474	250			insulated terminals, plug connectors and butt connectors	0,5 - 6	20 - 10	565
97 52 08	025481	250			insulated and non-insulated end sleeves (ferrules)	0,25 - 6	23 - 10	565
97 52 09	025498	250			insulated and non-insulated end sleeves (ferrules)	10 / 16 / 25	7 / 5 / 3	571
97 52 10	023678	250			Coax-, BNC- and TNC-connectors			577
97 52 13	048084	250			non-insulated crimp terminals, tube and compression cable lugs in accordance with DIN 46234 and DIN 46235 and non-insulated crimp, butt and press connectors in accordance with DIN 46341 and DIN 46267	0,5 - 10	20 - 7	558
97 52 19	052142	250			insulated and non-insulated end sleeves (ferrules)	35 - 50	2 / 0	567
97 52 23	052159	250			non-insulated terminals + cable connectors	16 / 25	5 / 3	565
97 52 18	026839	250			Twin end sleeves (ferrules) 2 x 6 / 2 x 10 / 2 x 16 mm ²		2 x 10 / 2 x 7 / 2 x 5	571
97 49 94	030997	Locator for 97 49 04 / 97 52 04 / 97 52 34						
97 49 95	031000	Locator for 97 49 05 / 97 52 05 / 97 52 35						

KNIPEX PreciForce®

Crimping Pliers

- > Consistently high crimping quality thanks to precision dies and forced locking mechanism (unlockable)
- > Crimping pressure has been set precisely (calibrated) in the factory, re-adjustable
- > Optimum transmission of force thanks to toggle lever for fatigue-reduced operation
- > Good handling thanks to favourable handle position, low weight, compact design and ergonomically shaped handles
- > Chrome vanadium electric steel in special quality, oil-hardened

For daily crimping applications, the specialist likes crimping pliers that work precisely and reliably. In addition, they should be light, comfortable to use, robust and reasonably priced: KNIPEX PreciForce®.



97 52 30



97 52 33



97 52 34



97 52 35



97 52 36



97 52 37



97 52 38



97 52 50



97 52 36



97 52 37



Article No.	EAN 4003773-	↔ mm			Applications	Capacity mm ²	AWG	Δ g
97 52 30	051855	220			compression joints according to DIN 46267	1,5 - 4 / 6 / 10	15 - 7	477
97 52 33	051862	220			non-insulated crimp terminals, tube and compression cable lugs in accordance with DIN 46234 and DIN 46235 and non-insulated crimp, butt and press connectors in accordance with DIN 46341 and DIN 46267	0,5 - 10	20 - 7	478
97 52 34	051879	220			non-insulated open plug type connectors (plug width 2.8 + 4.8 mm)	0,1 - 2,5	27 - 13	483
97 52 35	051886	220			non-insulated open plug type connectors (plug width 4.8 + 6.3 mm)	0,5 - 6	20 - 10	494
97 52 36	051893	220			insulated terminals + cable connectors	0,5 - 6	20 - 10	487
97 52 37	063193	220			heat shrinkable sleeve connectors	0,5 - 6	20 - 10	478
97 52 38	051909	220			insulated and non-insulated end sleeves (ferrules)	0,25 - 6	23 - 10	493
97 52 50	051916	220			COAX-, BNC- and TNC-connectors for RG 58; 174; 188; 316			498
97 49 94	030997	Locator for 97 49 04 / 97 52 04 / 97 52 34						
97 49 95	031000	Locator for 97 49 05 / 97 52 05 / 97 52 35						



Four-Mandrel Crimping Pliers for turned contacts

- > For crimping turned contacts
- > Four-mandrel crimping for top-quality crimping connections
- > Mandrel gauge to check the basic setting
- > Repetitive, high crimping quality due to integral lock (self-releasing mechanism)
- > Optimum transmission of force due to highly effective lever action for fatigue-reduced operation
- > High operation comfort thanks to handy shape
- > Chrome vanadium electric steel in special quality, oil-hardened

97 52 63

- > Fine adjustment of pressure depending on the conductor's diameter by means of adjusting wheel. Pliers in a plastic case with foam insert and standard locator for precise positioning of the contacts

97 52 63 DG

- > Crimping capacity can be adjusted in increments of 0.01 mm; With digital display of the preset crimping capacities and possibility of re-calibration via RESET function with electronic wear monitoring; Adjustment in mm, inches or comparable selection positions according to MIL; Pliers in a plastic case with foam insert and standard locator for precise positioning of the contacts

97 52 64

- > Pressure adjustment depending on the conductor's diameter by means of adjusting wheel in 4 different positions; Locator for positioning the contacts

97 52 65

- > Fine adjustment of pressure depending on the conductor's diameter by means of adjusting wheel; Locator for positioning the contacts; With table for calculating the settings; Pliers in a plastic case with foam insert

97 52 65 A

- > Fine adjustment of pressure depending on the conductor's diameter by means of adjusting wheel; With table for calculating the settings; Pliers in a plastic case with foam insert

97 52 65 DG

- > Crimping capacity can be adjusted in increments of 0.01 mm; With digital display of the preset crimping capacities and possibility of re-calibration via RESET function with electronic wear monitoring; Adjustment in mm, inches or comparable selection positions according to MIL; With table for calculating the settings; Pliers in a plastic case with foam insert and standard locator for precise positioning of the contacts

97 52 65 DG A

- > Crimping capacity can be adjusted in increments of 0.01 mm; With digital display of the preset crimping capacities and possibility of re-calibration via RESET function with electronic wear monitoring; Adjustment in mm, inches or comparable selection positions according to MIL; With table for calculating the settings; Pliers in a plastic case with foam insert; Without locator

97 59 65 2

- > Locator for holding turned contacts for crimping; Precisely adjustable to the length (20 - 45 mm) and diameter (1 - 8 mm) of the crimping connector; Locator that is universally adjustable (in length and diameter) for the repeatable exact alignment of turned contacts in crimping pliers; can be set to all commercially available turned contacts in the four-mandrel crimping pliers' capacity range



97 52 63



97 52 63 DG



97 52 64



97 52 65



97 52 65 A



97 52 65 DG



97 52 65 DG A



97 59 65 2
Universal Locator

Turned contacts are used for particularly demanding plug-type connections, e.g. in medical industry and aeronautics. Extremely reliable crimping connections can be achieved only with pliers that work with absolute precision and maintain the required crimping depth in the 1/100 mm range.

















Standard locator



Multi-functional digital display, adjustment in mm, inch or comparable selection positions according to MIL



Article No.	EAN 4003773-	↔ mm			Pliers	Handles	Applications	Capacity mm ²	AWG	⚖ g
97 52 63	050148	180			chrome plated	with multi-component grips	turned contacts	0.08 - 2.5	28 - 13	388
97 52 63 DG	063209	195			chrome plated	with multi-component grips	turned contacts	0.08 - 2.5	28 - 13	388
97 52 64	044093	180			chrome plated	with multi-component grips	turned contacts	0.08 - 2.5	28 - 13	424
97 52 65	045236	230			chrome plated	with multi-component grips	turned contacts (Harting; Ilme; Phoenix; Amphenol; Walther; HTS; Contact; Weidmüller)	0.14 - 6	25 - 10	676
97 52 65 A	071594	250			chrome plated	with multi-component grips	turned contacts (Harting; Ilme; Phoenix; Amphenol; Walther; HTS; Contact; Weidmüller)	0.14 - 6	25 - 10	604
97 52 65 DG	063216	250			chrome plated	with multi-component grips	turned contacts (Harting; Ilme; Phoenix; Amphenol; Walther; HTS; Contact; Weidmüller)	0.14 - 6	25 - 10	633
97 52 65 DG A	071990	250			chrome plated	with multi-component grips	turned contacts (Harting; Ilme; Phoenix; Amphenol; Walther; HTS; Contact; Weidmüller)	0.14 - 6	25 - 10	633
97 59 14	026976	Locator for 97 52 14								
97 59 65 2	071600	Universal Locator for 97 52 65 / 97 52 65 A / 97 52 65 DG / 97 52 65 DG A								

Self-Adjusting Crimping Pliers for wire ferrules

with lateral access

► Narrow handle width and improved ergonomics

- > For crimping wire ferrules according to DIN 46228 parts 1 + 4
- > Self-adjustment to the size of wire ferrules required
- > Repetitive, high crimping quality due to integral lock (self-releasing mechanism)
- > Tools have been set precisely (calibrated) in the factory
- > Optimum transmission of force thanks to toggle lever for fatigue-reduced operation
- > Handy shape and low weight provide high operation comfort
- > Chrome vanadium electric steel in special quality, oil-hardened



Crimping capacity can be switched over simply from 10 mm² to 16 mm².

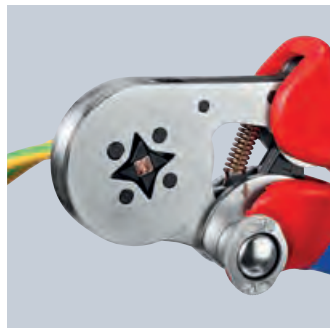

The small crimping pliers for wire end sleeves with two major advantages for the user:

- > Automatic adjustment to the end sleeves used: This makes work easier for the professional and offers reliable and fast crimping
- > Expanded range of applications



97 53 04



97 53 14



97 55 04



97 55 14

Article No.	EAN	↔ mm			Pliers	Handles	Applications	Capacity mm ²	AWG	⚖ g
97 53 04	028017	180		(PAT. PEND.)	burnished	with multi-component grips	Wire ferrules	0.08 - 10 / 16	28 - 5	459
97 53 14	041474	180		(PAT. PEND.)	burnished	with multi-component grips	Wire ferrules	0.08 - 10	28 - 7	445
97 55 04	084853	180		(PAT. PEND.)	chrome plated	with multi-component grips	Wire ferrules	0.08 - 10 / 16	28 - 5	459
97 55 14	084860	180		(PAT. PEND.)	chrome plated	with multi-component grips	Wire ferrules	0.08 - 10	28 - 7	445
97 59 30	053965	Extension spring for 97 53 4/5/8/9/14 thin								
97 59 31	053972	Extension spring for 97 53 4/5/8/9/14 thick								

KNIPEX Twistor16®

Self-Adjusting Crimping Pliers for wire ferrules with rotatable die head

- > Self-adjusting crimping pliers for wire ferrules with rotatable crimp head
- > Crimp head can be freely rotated 360°, with 8 locking positions
- > Square crimp profile, high capacity range from 0.14 to 16 mm²
- > Wire ferrules can be crimped from almost any working position
- > Crimping pliers adjust automatically to different cross-sections
- > Crimp opening accessible from both sides, extra-long wire ferrules can be fed in
- > Crimping of Twin wire ferrules up to 2 x 6 mm² possible
- > Repetitive, high crimping quality due to integral lock (self-releasing mechanism)
- > Light and handy tool, manual force reinforced by toggle lever mechanism
- > Chrome vanadium electric steel in special quality, oil-hardened



97 53 18

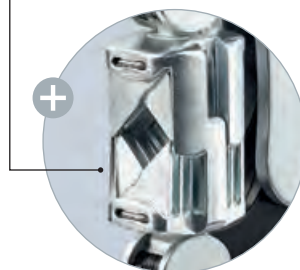

Crimp head can be freely rotated 360°



Crimp head can be rotated 360° for optimal accessibility, even in confined spaces



97 90 13

All-round care-free solution: KNIPEX Twistor16® with accessories in the practical TANOS MINI-systainer®



Twin wire ferrules up to 2 x 6 mm² can be crimped without adjustment



Uniquely flexible: connectors can be inserted in the rotatable crimp head from almost any position



Article No.	EAN	↔ mm			Pliers	Handles	Applications	Capacity mm ²	AWG	⚖ g
97 53 18	082729	240			chrome plated	with multi-component grips	Wire ferrules	0.14 - 16	26 - 5	478

Self-Adjusting Crimping Pliers for wire ferrules

with front loading

- > For crimping wire ferrules according to DIN 46228 parts 1 + 4
- > Self-adjusting adaptation to the desired wire ferrule size: no wrong crimps caused by using the wrong die
- > Frontal insertion of the wire ferrules into the pliers
- > Repetitive, high crimping quality due to integral lock (self-releasing mechanism)
- > Crimping pressure has been set precisely (calibrated) in the factory, re-adjustable
- > Optimum transmission of force thanks to toggle lever for fatigue-reduced operation
- > Handy shape and low weight provide high operation comfort
- > Chrome vanadium electric steel in special quality, oil-hardened

97 53 08

- > Compression from 0.08 - 10.0 mm² in one profile; wire end sleeves up to 2.5 mm² can also be loaded parallelly from the side; suitable in particular for all twin wire end sleeves up to 2 x 4 mm² or 2 x AWG 10

97 53 09

- > Compression from 0.08 - 10.0 and 16.0 mm² in one profile; with selector lever for setting the crimping area either to 0.08 - 10 mm² or 16 mm²; suitable in particular for all twin wire end sleeves up to 2 x 6 mm² or 2 x AWG 8



97 53 08



97 53 09



97 53 08: lateral loading of wire ferrules up to 2.5 mm² parallelly from the side e.g. in confined areas

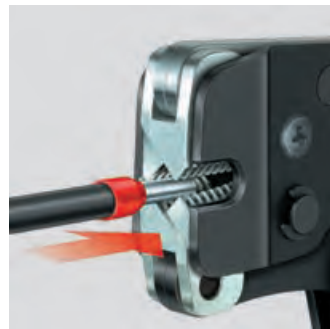

Front loading of wire ferrules e.g. in switchboards



Square-Crimp

The crimping pliers for end sleeves (ferrules) with three great advantages for the user:

- > Automatic self-adjustment to the wire end sleeve used: this allows the specialist to work with less strain and enables secure, reliable and quick crimping.
- > Range of applications also for large cross-sections: square crimping 0.08 to 10 + 16 mm²
- > Front loading: very helpful under difficult working conditions in confined areas.

Article No.	EAN	↔ mm			Pliers	Handles	Applications	Capacity mm ²	AWG	Δ g
97 53 08	040187	190			burnished	with multi-component grips	Wire ferrules	0.8 - 10	28 - 7	477
97 53 09	044550	190			burnished	with multi-component grips	Wire ferrules	0.08 - 10 / 16	28 - 5	486
97 59 30	053965	Extension spring for 97 53 4 / 5 / 8 / 9 / 14 thin								
97 59 31	053972	Extension spring for 97 53 4 / 5 / 8 / 9 / 14 thick								

Crimping Pliers for micro plugs

parallel crimping

- > Parallel crimping performance to satisfy the particularly high standards of small connectors
- > Consistently high crimping quality thanks to precision dies and forced locking mechanism (unlockable)
- > Crimping pressure has been set precisely (calibrated) in the factory, re-adjustable
- > Optimum transmission of force thanks to toggle lever for fatigue-reduced operation
- > Crimping pliers for other mini plugs such as HD 22, Modu IV, Micro Timer, MQS ... on request
- > Chrome vanadium electric steel in special quality, oil-hardened



97 54 24



97 54 25

97 54 26



97 54 27

Article No.	EAN 4003773-	↔ mm			Pliers	Handles	Applications	Capacity mm²	AWG	Δ g
97 54 24	060215	190			burnished	with multi-component grips	D Sub; HD 20; HDE plug	0.03 - 0.56	32 - 20	305
97 54 25	079859	190			burnished	with multi-component grips	for crimping connectors from the Micro-Fit™ series from Molex LLC		30 - 26 / 24 - 22 / 20	305
97 54 26	079866	190			burnished	with multi-component grips	for crimping connectors in the Mini-Fit® series from Molex LLC		16 / 18 / 20 - 24	305
97 54 27	079873	190			burnished	with multi-component grips	MQS connectors	0.25 / 0.35 / 0.5		305

Crimping Pliers for wire ferrules

with trapezoid crimp

- > For crimping wire ferrules according to DIN 46228 parts 1 + 4 in the range from 0.25 up to 2.5 mm²
- > Crimping in marked trapezoidal dies for reliable connections between the sleeve and the conductor
- > Vanadium electric steel; forged, oil-hardened



97 61 145 A



97 68 145 A

Article No.	EAN 4003773-	↔ mm			Head	Handles	Capacity mm²	AWG	Δ g
97 61 145 A	035558	145			polished	plastic coated	0.25 - 2.5	23 - 13	140
97 61 145 F	043980	145			polished	plastic coated	0.25 - 2.5	23 - 13	140
97 62 145 A	060154	145			polished	with multi-component grips	0.25 - 2.5	23 - 13	170
97 68 145 A	071754	145			polished	insulated with multi-component grips, VDE-tested	0.25 - 2.5	23 - 13	175

Crimping Pliers for wire ferrules

with mandrel crimp

- ▶ Light and slim design
- ▶ Also as VDE version
- ▶ Easy crimping due to optimised transmission ratio

- > For crimping wire ferrules according to DIN 46228 parts 1 + 4 from 0.25 to 16 mm²
- > Crimping in marked half-round dies for reliable connections between the sleeve and the conductor
- > 9 particularly deep dies with conical side faces
- > Special tool steel, forged, oil-hardened



97 71 180



97 72 180









97 78 180



97 78 180 T



Article No.	EAN 4003773-	↔ mm		Head	Handles	Applications	Capacity mm ²	AWG	⚖ g
97 71 180	040668	180		polished	plastic coated	Wire ferrules	0.25 - 16	23 - 5	205
97 72 180	060185	180		polished	with multi-component grips	Wire ferrules	0.25 - 16	23 - 5	242
97 78 180	072003	180	 	polished	insulated with multi-component grips, VDE-tested	Wire ferrules	0.25 - 16	23 - 5	254
97 78 180 T	081531	180	 	polished	insulated with multi-component grips, with integrated insulated tether attachment point, VDE tested	Wire ferrules	0.25 - 16	23 - 5	260

Crimping Pliers for wire ferrules

with front loading

- > For crimping wire ferrules according to DIN 46228 parts 1 + 4 in the range 0.5 to 6 mm²
- > Ideal for work in confined areas, e.g. in narrow and deep switch boxes
- > Special tool steel, forged, oil-hardened



97 81 180



Article No.	EAN	↔ mm			Head	Handles	Applications	Capacity mm ²	AWG	△ g
97 81 180	4003773-019794	180		<input checked="" type="checkbox"/>	polished	plastic coated	Wire ferrules	0.5 - 6	20 - 10	209



Crimp Assortments

for non-insulated wire ferrules

- > In a TANOS MINI-systainer® (solid plastic box)
- > T-Loc fastener for one-handed operation: open or close the systainer® with one turn and connect to a second systainer®
- > Opening when connected: fast and simple access to content without disconnecting
- > Two stackable plastic inserts with 6 trays each for connectors
- > With an assortment of wire ferrules with/without collar

97 90 05

- > With Crimping Pliers for end sleeves 97 71 180; Wire end sleeves without collar

97 90 17

- > With crimping pliers for wire ferrules 97 53 09 and self-adjusting insulation stripper 12 42 195

97 90 23

- > With Crimping Pliers PreciForce® for wire end sleeves 97 52 38

97 90 24

- > With Self-Adapting Universal Insulation Stripper Multistrip 10, 12 42 195; With Self-Adjusting Crimping Pliers for wire end sleeves 97 53 08

97 90 06

- > With Crimping Pliers for end sleeves 97 71 180; Wire end sleeves with collar

97 90 09

- > With Self-Adjusting Crimping Pliers for wire end sleeves 97 53 04

97 90 10

- > With Self-Adjusting Insulation Stripper 12 40 200; With Self-Adjusting Crimping Pliers for wire end sleeves 97 53 04

97 90 12

- > With Self-Adjusting Insulation Stripper 12 40 200; With Self-Adjusting Crimping Pliers for wire end sleeves 97 53 08

97 90 13

- > With KNIPEX Twistor16® 97 53 18 crimping pliers for wire ferrules

97 90 14

- > With crimping pliers for wire ferrules KNIPEX Twistor16® 97 53 18 and automatic insulation stripper KNIPEX PreciStrip16 12 52 195

97 90 15

- > With crimping pliers for wire ferrules 97 53 09 and automatic insulation stripper KNIPEX PreciStrip16 12 52 195

97 90 16

- > With crimping pliers for wire ferrules 97 53 09 and self-adjusting insulation stripper 12 40 200



97 90 05



97 90 10



97 90 13



97 90 23



Several boxes can be connected with each other

Article No.	EAN 4003773-		Pliers	200 x mm ²	150 x mm ²	100 x mm ²	75 x mm ²	50 x mm ²	40 x mm ²	± g
97 90 05	025535		97 71 180	0,5 / 0,75 / 1 / 1,5 / 2,5	4 / 6			10 / 16		930
97 90 06	025542		97 71 180	0,5 / 0,75 / 1 / 1,5	2,5		6	10	16	1000
97 90 09	028574		97 53 04	0,5 / 0,75 / 1 / 1,5 / 2,5		4 / 6		10		1420
97 90 10	046202		12 40 200 97 53 04	0,5 / 0,75 / 1 / 1,5 / 2,5		4 / 6		10		1353
97 90 12	048916		12 40 200 97 53 08	0,5 / 0,75 / 1 / 1,5 / 2,5		4 / 6		10		1427
97 90 13	083474		97 53 18	0,5 / 0,75 / 1 / 1,5	2,5		6	10	16	1270
97 90 14	084884		97 53 18 12 52 195	0,5 / 0,75 / 1 / 1,5	2,5		6	10	16	1450
97 90 15	084877		97 53 09 12 52 195			1,5 / 2,5		6	4	1450
97 90 16	086024		12 40 200 97 53 09	0,5 / 0,75 / 1 / 1,5 / 2,5		4 / 6		10		1450
97 90 17	086031		97 53 09	0,5 / 0,75 / 1 / 1,5 / 2,5		4 / 6		10		1450
97 90 23	062158		97 52 38	0,5 / 0,75 / 1 / 1,5 / 2,5		4 / 6				1226
97 90 24	062394		97 53 08	0,5 / 0,75 / 1 / 1,5 / 2,5		4 / 6		10		1348
97 90 00 LE	054009	TANOS MINI-systainer® empty								900

Crimp Assortments

for cable connectors

- > In a TANOS MINI-systainer® (solid plastic box)
- > T-Loc fastener for one-handed operation: open or close the systainer® with one turn and connect to a second systainer®
- > Opening when connected: fast and simple access to content without disconnecting
- > Two stackable plastic inserts with 6 trays each for connectors
- > With an assortment of standard cable connectors

97 90 21

- > With Crimping Pliers KNIPEX PreciForce® 97 52 36 (for insulated terminals and plug connectors)

97 90 22

- > With Self-Adapting Universal Insulation Stripper KNIPEX Multi-strip 10, 12 42 195; with Crimping Pliers KNIPEX PreciForce® 97 52 36 (for insulated terminals and plug connectors)

97 90 25

- > With crimping pliers 97 22 240

97 90 26

- > With crimping pliers 97 32 240



97 90 21



97 90 22



97 90 25



97 90 26

Article No.	EAN	Image	Pliers	Cable Connectors			g
				Quantity	Cable mm ²		
97 90 21	062134		97 52 36	Blade Terminal Sockets, 6.3 x 0.8 mm	25	0,5 - 1	1416
					25	1,5 - 2,5	
					25	0,5 - 1	
				Round Sockets, Ø 4 mm	25	0,5 - 1	
				Cable Connectors, eye type, Ø 4 mm	25	4 - 6	
					25	4 - 6	
				Cable Connectors, eye type, Ø 5 mm	25	1,5 - 2,5	
					25	1,5 - 2,5	
				Cable Connectors, eye type, Ø 6 mm	25	1,5 - 2,5	
				Butt Connectors, insulated, red	25	0,5 - 1	
				Butt Connectors, insulated, blue	25	4 - 6	
				Round Pin Plugs, Ø 4 mm	25	1,5 - 2,5	
97 90 22	062141		97 52 36 12 42 195	Blade Terminal Sockets, 6.3 x 0.8 mm	25	0,5 - 1	1527
					25	1,5 - 2,5	
				Cable Connectors, eye type, Ø 4 mm	25	0,5 - 1	
				Cable Connectors, eye type, Ø 5 mm	25	0,5 - 1	
				Cable Connectors, eye type, Ø 6 mm	25	1,5 - 2,5	
				Cable Connectors, eye type, Ø 8 mm	25	1,5 - 2,5	
				Cable Connectors, eye type, Ø 4 mm	25	1,5 - 2,5	
				Cable Connectors, eye type, Ø 5 mm	25	4 - 6	
				Cable Connectors, eye type, Ø 6 mm	25	4 - 6	
				Butt Connectors, insulated, red	25	0,5 - 1	
				Butt Connectors, insulated, blue	25	1,5 - 2,5	
				Butt Connectors, insulated, yellow	25	4 - 6	
97 90 25	076971		97 22 240	Blade Terminal Sockets, 6.3 x 0.8 mm	25	0,5 - 1,5	1150
					25	1 - 2,5	
				Cable Connectors, eye type, Ø 4 mm	25	0,5 - 1	
				Cable Connectors, eye type, Ø 5 mm	25	1,5 - 2,5	
				Cable Connectors, eye type, Ø 4 mm	25	4 - 6	
				Cable Connectors, eye type, Ø 5 mm	25	0,5 - 1	
				Cable Connectors, eye type, Ø 6 mm	25	1,5 - 2,5	
					25	0,5 - 1	
				Cable Connectors, eye type, Ø 8 mm	25	1,5 - 2,5	
				Butt Connectors, insulated, red	25	0,5 - 1	
				Butt Connectors, insulated, blue	25	1,5 - 2,5	
				Butt Connectors, insulated, yellow	25	4 - 6	
97 90 26	079521		97 32 240	Non-insulated Blade Terminal Sockets 6.3 x 0.8 mm	25	1,5 - 2,5	1420
					25	4 - 6	
				Blade Terminal Sockets 6.3 x 0.8 mm	25	0,5 - 1	
					25	0,5 - 1	
				Blade Terminal Plugs 6.3 x 0.8 mm	25	1,5 - 2,5	
					25	4 - 6	
				Cable Connectors, eye type Ø 4 mm	25	4 - 6	
					25	0,5 - 1	
				Butt Connectors, insulated, red	25	1,5 - 2,5	
				Butt Connectors, insulated, blue	25	0,5 - 1	
				Butt Connectors, insulated, yellow	25	0,5 - 1	
				97 90 00 LE	054009	TANOS MINI-systainer® empty	

Blade Terminal Sockets

insulated

Article No.	EAN 4003773-		Width x Thickness mm ²	Cable mm ²	AWG	Colour	
97 99 001	075882	Blade Terminal Sockets insulated	2.8 x 0.5	0.5 - 1	20 - 17	Red	100
97 99 010	075899	Blade Terminal Sockets insulated	4.8 x 0.8	0.5 - 1	20 - 17		100
97 99 020	075912	Blade Terminal Sockets insulated	6.3 x 0.8	0.5 - 1	20 - 17		100
97 99 011	075905	Blade Terminal Sockets insulated	4.8 x 0.8	1.5 - 2.5	15 - 13	Blue	100
97 99 021	075929	Blade Terminal Sockets insulated	6.3 x 0.8	1.5 - 2.5	15 - 13		100
97 99 030	075943	Blade Terminal Sockets insulated	7.7 x 0.8	1.5 - 2.5	15 - 13		100
97 99 022	075936	Blade Terminal Sockets insulated	6.3 x 0.8	4 - 6	11 - 10	Yellow	100



97 99 022

Plug Connectors

non-insulated

Article No.	EAN 4003773-		Width x Thickness mm ²	Cable mm ²	AWG		
97 99 050	075950	Plug connector non-insulated	2.8 x 0.8	0.5 - 1	20 - 17		100
97 99 060	075967	Plug connector non-insulated	4.8 x 0.8	1.5 - 2.5	16 - 14		100
97 99 070	075974	Plug connector non-insulated	6.3 x 0.8	0.5 - 1.5	20 - 15		100
97 99 071	075981	Plug connector non-insulated	6.3 x 0.8	1 - 2.5	17 - 14		100



97 99 050

Flat Pin Accessory Distributors

insulated

Article No.	EAN 4003773-		Width x Thickness mm ²	Cable mm ²	AWG	Colour	
97 99 090	075998	Flat Pin Accessory Distributors insulated	6.3 x 0.8	0.5 - 1	20 - 17	Red	100
97 99 091	076001	Flat Pin Accessory Distributors insulated	6.3 x 0.8	1.5 - 2.5	15 - 13	Blue	100
97 99 092	076018	Flat Pin Accessory Distributors insulated	6.3 x 0.8	4 - 6	11 - 10	Yellow	100



97 99 091

Blade Terminal Plugs

insulated

Article No.	EAN 4003773-		Width x Thickness mm ²	Cable mm ²	AWG	Colour	
97 99 110	076025	Blade Terminal Plug insulated	6.3 x 0.8	0.5 - 1	20 - 17	Red	100
97 99 111	076032	Blade Terminal Plug insulated	6.3 x 0.8	1.5 - 2.5	15 - 13	Blue	100
97 99 112	076049	Blade Terminal Plug insulated	6.3 x 0.8	4 - 6	11 - 10	Yellow	100



97 99 111

Round Sockets

insulated

Article No.	EAN 4003773-		Plug Ø mm	Cable mm ²	AWG	Colour	
97 99 130	076056	Round Sockets insulated	4.0	0.5 - 1	20 - 17	Red	100
97 99 131	076063	Round Sockets insulated	5.0	1.5 - 2.5	15 - 13	Blue	100



97 99 131

Round Pin Plugs

insulated

Article No.	EAN 4003773-		Plug Ø mm	Cable mm ²	AWG	Colour	
97 99 150	076070	Round Pin Plug insulated	4.0	0.5 - 1	20 - 17	Red	100
97 99 151	076087	Round Pin Plug insulated	5.0	1.5 - 2.5	15 - 13	Blue	100



97 99 151

Cable Connectors, eye type

insulated

> DIN 46237

Article No.	EAN 4003773-		Screws Ø mm	Cable mm ²	AWG	Colour	
97 99 170	076094	Cable Connectors, eye type insulated	3.0	0.5 - 1	20 - 17	Red	200
97 99 171	076100	Cable Connectors, eye type insulated	4.0	0.5 - 1	20 - 17		200
97 99 172	076117	Cable Connectors, eye type insulated	5.0	0.5 - 1	20 - 17		200
97 99 173	076124	Cable Connectors, eye type insulated	4.0	1.5 - 2.5	15 - 13	Blue	100
97 99 174	076131	Cable Connectors, eye type insulated	5.0	1.5 - 2.5	15 - 13		100
97 99 175	076148	Cable Connectors, eye type insulated	6.0	1.5 - 2.5	15 - 13		100
97 99 176	076155	Cable Connectors, eye type insulated	8.0	1.5 - 2.5	15 - 13		100
97 99 177	076162	Cable Connectors, eye type insulated	5.0	4 - 6	11 - 10	Yellow	100
97 99 178	076179	Cable Connectors, eye type insulated	6.0	4 - 6	11 - 10		100
97 99 179	076186	Cable Connectors, eye type insulated	8.0	4 - 6	11 - 10		100
97 99 180	076193	Cable Connectors, eye type insulated	10.0	4 - 6	11 - 10		100



97 99 170

Non-insulated Solderless Terminals

> DIN 46234

Article No.	EAN 4003773-		Screws Ø mm	Cable mm ²	AWG	
97 99 210	076209	Non-insulated Solderless Terminals	3.0	0.5 - 1	20 - 17	200
97 99 211	076216	Non-insulated Solderless Terminals	4.0	0.5 - 1	20 - 17	200
97 99 212	076223	Non-insulated Solderless Terminals	5.0	0.5 - 1	20 - 17	200
97 99 213	076230	Non-insulated Solderless Terminals	4.0	1.5 - 2.5	15 - 13	100
97 99 214	076247	Non-insulated Solderless Terminals	5.0	1.5 - 2.5	15 - 13	100
97 99 215	076254	Non-insulated Solderless Terminals	6.0	1.5 - 2.5	15 - 13	100
97 99 216	076261	Non-insulated Solderless Terminals	8.0	1.5 - 2.5	15 - 13	100
97 99 217	076278	Non-insulated Solderless Terminals	5.0	4 - 6	11 - 10	100
97 99 218	076285	Non-insulated Solderless Terminals	6.0	4 - 6	11 - 10	100
97 99 219	076292	Non-insulated Solderless Terminals	8.0	4 - 6	11 - 10	100
97 99 220	076308	Non-insulated Solderless Terminals	10.0	4 - 6	11 - 10	100



97 99 210

Heat Shrinkable Butt Connectors

Article No.	EAN 4003773-		Cable mm ²	AWG	Colour	
97 99 250	076315	Heat Shrinkable Butt Connectors	0.75 - 1	20 - 18	Red	100
97 99 251	076322	Heat Shrinkable Butt Connectors	1.5 - 2.5	15 - 13	Blue	100
97 99 252	076339	Heat Shrinkable Butt Connectors	4 - 6	11 - 10	Yellow	100



97 99 252

Butt Connectors, insulated

Article No.	EAN 4003773-		Cable mm ²	AWG	Colour	
97 99 270	076346	Butt Connectors, insulated	0.75 - 1	20 - 18	Red	100
97 99 271	076353	Butt Connectors, insulated	1.5 - 2.5	15 - 13	Blue	100
97 99 272	076360	Butt Connectors, insulated	4 - 6	11 - 10	Yellow	100



97 99 272

Butt Connectors, non-insulated

> DIN 46341-B

Article No.	EAN 4003773-		Cable mm ²	AWG	
97 99 290	076377	Butt Connectors, non-insulated	0.75 - 1	20 - 18	200
97 99 291	076384	Butt Connectors, non-insulated	1.5 - 2.5	15 - 13	200
97 99 292	076391	Butt Connectors, non-insulated	4 - 6	11 - 10	100
97 99 293	076407	Butt Connectors, non-insulated	10	7	100



97 99 290

Wire ferrules with plastic collar

Article No.	EAN 4003773		↔ mm	Cable mm ²	AWG	Colour	
97 99 330	076414	Wire ferrules with plastic collar	14.0	0.5	20	white	200
97 99 331	076421	Wire ferrules with plastic collar	14.0	0.75	18	grey	200
97 99 335	076469	Wire ferrules with plastic collar	17.0	4	11	grey	200
97 99 332	076438	Wire ferrules with plastic collar	14.0	1	17	Red	200
97 99 333	076445	Wire ferrules with plastic collar	14.0	1.5	15	black	200
97 99 334	076452	Wire ferrules with plastic collar	14.0	2.5	13	Blue	200
97 99 336	076476	Wire ferrules with plastic collar	20.0	6	10	Yellow	100
97 99 337	076483	Wire ferrules with plastic collar	22.0	10	7	Red	100
97 99 338	076490	Wire ferrules with plastic collar	24.0	16	5	Blue	100
97 99 339	076506	Wire ferrules with plastic collar	30.0	25	3	Yellow	50
97 99 350	076513	Wire ferrules with plastic collar	16.0	0.5	20	white	200
97 99 351	076520	Wire ferrules with plastic collar	16.0	0.75	18	grey	200
97 99 352	076537	Wire ferrules with plastic collar	16.0	1	17	Red	200
97 99 353	076544	Wire ferrules with plastic collar	16.0	1.5	15	black	200
97 99 354	076551	Wire ferrules with plastic collar	16.0	2.5	13	Blue	200
97 99 355	076568	Wire ferrules with plastic collar	20.0	4	11	grey	200
97 99 356	076575	Wire ferrules with plastic collar	26.0	6	10	Yellow	100
97 99 357	076582	Wire ferrules with plastic collar	28.0	10	7	Red	100
97 99 358	076599	Wire ferrules with plastic collar	28.0	16	5	Blue	100
97 99 359	076605	Wire ferrules with plastic collar	32.0	25	3	Yellow	50



97 99 353



97 99 336

Twin wire ferrules

with plastic collar

Article No.	EAN 4003773		↔ mm	Cable mm ²	AWG	Colour	
97 99 370	076612	Twin wire ferrules with plastic collar	15.0	2 x 0.5	2 x 20	white	200
97 99 371	076629	Twin wire ferrules with plastic collar	16.0	2 x 0.75	2 x 18	grey	200
97 99 372	076636	Twin wire ferrules with plastic collar	15.0	2 x 1	2 x 17	Red	200
97 99 373	076643	Twin wire ferrules with plastic collar	18.0	2 x 1.5	2 x 15	black	200
97 99 374	076650	Twin wire ferrules with plastic collar	18.0	2 x 2.5	2 x 13	Blue	100
97 99 375	076667	Twin wire ferrules with plastic collar	23.0	2 x 4	2 x 11	grey	100
97 99 376	076674	Twin wire ferrules with plastic collar	26.0	2 x 6	2 x 10	Yellow	50
97 99 377	076681	Twin wire ferrules with plastic collar	24.0	2 x 10	2 x 7	Red	50
97 99 378	076698	Twin wire ferrules with plastic collar	29.0	2 x 16	2 x 5	Blue	25



97 99 374

Non-insulated wire ferrules

> DIN 46228-1

Article No.	EAN 4003773		↔ mm	Cable mm ²	AWG	
97 99 390	076704	Non-insulated wire ferrules	6.0	0.5	20	200
97 99 391	076711	Non-insulated wire ferrules	6.0	0.75	18	200
97 99 392	076728	Non-insulated wire ferrules	6.0	1	17	200
97 99 393	076735	Non-insulated wire ferrules	7.0	1.5	15	200
97 99 394	076742	Non-insulated wire ferrules	7.0	2.5	13	200
97 99 395	076759	Non-insulated wire ferrules	9.0	4	11	200
97 99 396	076766	Non-insulated wire ferrules	12.0	6	10	100
97 99 397	076773	Non-insulated wire ferrules	12.0	10	7	100
97 99 398	076780	Non-insulated wire ferrules	12.0	16	5	100
97 99 399	076797	Non-insulated wire ferrules	12.0	25	3	50



97 99 390

Assortment Boxes

► Practical dispenser box, stackable and reclosable

- > Handy, transparent dispenser box
- > Rotating lid with opening to remove individual wire ferrules
- > Format: Ø 90 mm, height 44 mm



Article No.	EAN 4003773-	Quantity	Cable mm ²	AWG	Length of crimp area	↔ mm	Colour	Size	⚖ g
With insulated wire ferrules, with insulated wire ferrules by DIN colour code									
97 99 905	082446								70
		30	0.25	24	6.0	10.0		Ø 90 x 44	
		30	0.34	22	6.0	10.0		Ø 90 x 44	
		30	0.5	20	8.0	14.0	white	Ø 90 x 44	
		30	0.75	18	8.0	14.0	grey	Ø 90 x 44	
		30	1	17	8.0	14.0	red	Ø 90 x 44	
97 99 906	082453								95
		50	0.5	20	8.0	14.0	white	Ø 90 x 44	
		100	0.75	18	8.0	14.0	grey	Ø 90 x 44	
		100	1	17	8.0	14.0	red	Ø 90 x 44	
		100	1.5	15	8.0	14.0	black	Ø 90 x 44	
		50	2.5	13	8.0	14.0	blue	Ø 90 x 44	
97 99 907	082460								90
		50	4	11	10.0	17.0	grey	Ø 90 x 44	
		20	6	10	12.0	20.0	yellow	Ø 90 x 44	
		20	10	7	12.0	22.0	red	Ø 90 x 44	
		10	16	5	12.0	24.0	blue	Ø 90 x 44	
With Twin wire ferrules, with insulated wire ferrules by DIN colour code									
97 99 908	082477								95
		50	2 x 0.75	2 x 18	8.0	16.0	grey	Ø 90 x 44	
		50	2 x 1	2 x 17	8.0	15.0	red	Ø 90 x 44	
		50	2 x 1.5	2 x 15	10.0	18.0	black	Ø 90 x 44	
		50	2 x 2.5	2 x 13	9.0	18.0	blue	Ø 90 x 44	
97 99 909	082484								85
		20	4	2 x 11	12.0	23.0	grey	Ø 90 x 44	
		10	2 x 6	2 x 10	12.0	24.0	yellow	Ø 90 x 44	
		10	2 x 10	2 x 7	12.0	24.0	red	Ø 90 x 44	
		5	2 x 16	2 x 5	16.0	29.0	blue	Ø 90 x 44	
With non-insulated wire ferrules, rotating lid with opening to remove individual wire ferrules									
97 99 910	082491								145
		500	0.5	20		6.0		Ø 90 x 44	
		500	0.75	18		6.0		Ø 90 x 44	
		400	1	17		6.0		Ø 90 x 44	
		300	1.5	15		7.0		Ø 90 x 44	
		200	2.5	13		7.0		Ø 90 x 44	
97 99 911	082507								140
		150	4	11		9.0		Ø 90 x 44	
		75	6	10		12.0		Ø 90 x 44	
		75	10	7		12.0		Ø 90 x 44	
		50	16	5		12.0		Ø 90 x 44	

F-compression connector

- > Suitable for coax cable with outer diameter of 7 mm and dielectric from 4.7 mm diameter (all standard coax cable with Ø 1.1 mm inner conductor)
- > Nitin-6™ coating ensures excellent protection against environmental influences
- > Waterproof (8 h /at a depth of 30 m), ideal for connection to LNB and external antennae
- > Suitable for KNIPEX 97 40 20 compression tool
- > 10 Cablecon F-compression connectors in a blister pack



97 99 500

Article No.	EAN 4003773-	
97 99 500	082378	10



Insulated Tools

Pliers	198
Precision Tweezers	212
Cable Shears	212
Cable Cutters	215
Wire Rope and ACSR-Cable Cutters	217
Crimping Pliers	218
Wrenches	219
Screwdrivers	222
Sockets with Torx drive	226
T-handle	226
Reversible Ratchets	226
Hexagon Sockets	227
Torque Wrenches	229
Cable Knives	230
Stripping Knives	230
Insulated Pliers of plastic	231
Insulating Clamp from plastic	232
Plastic Slip-On Caps	232
Self-Clamping Slip-On Caps	232
Electricians' Gloves	232
Insulating Mats	233
Stand Mats	233
PUK® Junior Hacksaw	233
Tool Kits	234





Testing dielectric strength, subjecting each pair of pliers to a load of 10,000 V AC.

Insulated tools are a matter of trust

Professionals trust their tools. This trust is vital when working on electrical installations. In this case, the electrician holding the pliers is also holding his life in his hands. Our insulated tools therefore not only meet statutory requirements, but also offer the greatest possible safety, reliability and performance.





Testing the adhesion of the insulating coating at 500 N.



Pressure test at 70°C.



Low temperature impact test at -25°C.



Testing the electrical insulating properties.

Regulated by standards

Only trained professionals are allowed to work on live installations. Such work is subject to strict occupational health and safety standards such as the German DIN VDE 0105 and the international EN 50110 and IEC 60364. In each case they must deploy special tools that have been specifically manufactured and tested for this work. Which requirements have to be met by tools used in live work is determined by DIN EN / IEC 60900. KNIPEX tools which bear the special mark **⚡ 1000 V** are approved for work up to 1000 V AC.

Guaranteed individually checked

Every insulated tool undergoes, one by one, a dielectric strength at 10,000 V AC before we sell it. This means that work in the area up to 1,000 V AC has a safety buffer of ten times the permitted maximum limit. Other procedures check the reliability of the insulation towards heat, cold, tensile and impact force. In addition to the KNIPEX quality assurance team, external institutes and test centres such as the VDE guarantee that all VDE criteria have been satisfied. We go through this effort to safeguard the user. He trusts his well-being with our pliers, day in and day out. In return we want to give him the best possible safety at all times. We stand by this responsibility with our name on the insulation of KNIPEX tools.

Strong beneath the insulation

The insulation provides safety when handling electrical installations, but it does not cut, grip or crimp. The mechanical properties of the basic tool, such as cutting performance, precision and stability, therefore style part of the overall quality of insulated tools.

With our insulated pliers, users can depend on the quality and durability of products from KNIPEX production. For assembly tools insulated by us, we use basic tools from tried and tested suppliers whose quality we subject to regular, stringent checks. The expert can rely on this double dependability of tool and insulation.

Always comply with the currently valid regulations and observe the SAFETY INSTRUCTIONS given below:

- > Insulated tools must be transported in a manner that will prevent any damage to the insulation.
- > Check before every use whether the insulation is damaged in any way, defective tools must be discarded.
- > Always keep your insulated tools clean and dry.
- > Wear protective goggles when working with cutting nippers or working overhead.
- > Always wear goggles or a facial mask when working on live equipment.
- > Make sure the workplace is clean and orderly, particularly when you are working on live installations.
- > Wear protective clothing and use SAFETY equipment (e.g. insulating gloves, insulating mats, protective covers) especially in confined working spaces.
- > Use only a tool with suitable dimensions. That will prevent slipping on the workpiece and unintentional contact with non-insulated parts.
- > Make sure that detached parts or cut-off ends of conductors do not fall onto live parts.

Combination Pliers

Chrome Vanadium

- > For heavy duty
- > With gripping zones for flat and round material, suitable for versatile use
- > With cutting edges for soft, hard and piano wire
- > Long cutting edges for thicker cables
- > Cutting edges additionally induction-hardened, cutting edge hardness approx. 64 HRC
- > Particularly wear resistant gripping jaws; hardness of the gripping jaws approx. 53 HRC
- > Chrome vanadium heavy-duty steel, forged, multi stage oil-hardened
- > DIN ISO 5746, DIN EN 60900, IEC 60900



01 06 160

Article No.	EAN 4003773	↔ mm	Icons	Pliers	Head	Handles	Cutting capacities				
							Ø mm	Ø mm	Ø mm	mm ²	Δ g
01 06 160	040729	160	Icons	chrome plated	chrome plated	insulated with multi-component grips, VDE-tested	2.0	1.5	10.0	16	220
01 06 190	040415	190	Icons	chrome plated	chrome plated	insulated with multi-component grips, VDE-tested	2.5	2.0	13.0	25	320

High Leverage Combination Pliers

- ▶ 35 % less effort required than with conventional combination pliers
- ▶ With cutting edges (hardness approx. 63 HRC) for heavy duty
- > Easier work due to optimised leverage
- > Easier cutting, powerful gripping, bending and pulling
- > Long cutting edges for thicker cables
- > With gripping zones for flat and round material, suitable for versatile use
- > Cutter head: special high-grade tool steel, forged, oil-hardened
- > DIN ISO 5746, DIN EN 60900, IEC 60900



02 06 180



02 07 225

Article No.	EAN 4003773	↔ mm	Icons	Pliers	Head	Handles	Cutting capacities				
							Ø mm	Ø mm	Ø mm	mm ²	Δ g
02 06 180	010012	180	Icons	chrome plated	chrome plated	insulated with multi-component grips, VDE-tested	2.5	2.0	11.5	16	247
02 06 200	010029	200	Icons	chrome plated	chrome plated	insulated with multi-component grips, VDE-tested	2.8	2.2	13.0	25	343
02 06 225	010036	225	Icons	chrome plated	chrome plated	insulated with multi-component grips, VDE-tested	3.0	2.5	14.0	25	425
02 07 200	022299	200	Icons	chrome plated	chrome plated	with dipped insulation, VDE-tested	2.8	2.2	13.0	25	380
02 07 225	022305	225	Icons	chrome plated	chrome plated	with dipped insulation, VDE-tested	3.0	2.5	14.0	25	486

Combination Pliers

- > With gripping zones for flat and round material, suitable for versatile use
- > With cutting edges for soft and hard wire
- > Long cutting edges for thicker cables
- > Cutting edges additionally induction-hardened, cutting edge hardness approx. 60 HRC
- > Special tool steel, forged, multi stage oil-hardened
- > DIN ISO 5746, DIN EN 60900, IEC 60900

03 06 180 T*

- > Pliers with tether attachment point for mounting a fall protection

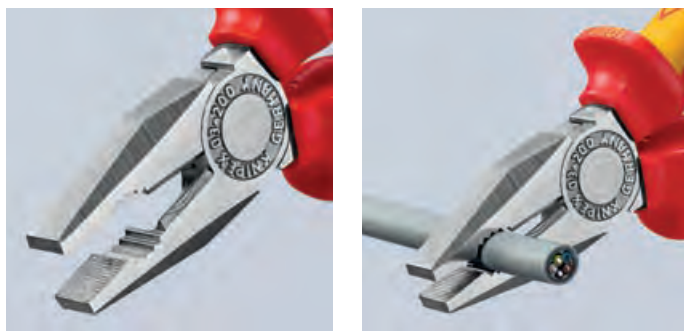

03 06 180



03 06 180 T



03 07 200

Article No.	EAN	↔ mm	1000 V	Pliers	Head	Handles	Cutting capacities				
							Ø mm	Ø mm	Ø mm	mm ²	Δ g
03 06 160	4003773	160					3.1	2.0	10.0	16	228
03 06 180	021902	180		chrome plated	chrome plated	insulated with multi-component grips, VDE-tested	3.4	2.2	12.0	16	264
03 06 200	033776	200		chrome plated	chrome plated	insulated with multi-component grips, VDE-tested	3.8	2.5	13.0	16	355
03 06 180 T	081395	180		chrome plated	chrome plated	insulated with multi-component grips with integrated insulated tether attachment point, VDE tested	3.4	2.2	12.0	16	270
03 07 160	015307	160					3.1	2.0	10.0	16	254
03 07 180	015314	180		chrome plated	chrome plated	with dipped insulation, VDE-tested	3.4	2.2	12.0	16	285
03 07 200	015321	200		chrome plated	chrome plated	with dipped insulation, VDE-tested	3.8	2.5	13.0	16	339
03 07 250	015345	250					3.8	2.5	15.0	25	597



*Other tools with tethering can be found from page 266

Needle-Nose Combination Pliers

Small High Leverage Combination Pliers with pointed jaw. For all common installation and repair work.

- ▶ Handy use when working in confined areas thanks to slim head design and pointed jaws (anti-twist)
 - ▶ Gripping surfaces with special convex contour on one side for secure gripping of flat parts
 - ▶ Milled groove in the gripping area permits small parts such as nails, pins and bolts to be held and pulled
- > The reliable and diverse combination pliers when out and about
 - > Easy cutting thanks to the high leverage joint
 - > With cutting edges for soft, medium-hard and hard wire
 - > Long service life and stable tips
 - > Forged from special high grade tool steel, manifold oil-hardened
 - > DIN ISO 5746, DIN EN 60900, IEC 60900



08 26 145



08 26 145 T

08 26 145 T*

- > Pliers with tether attachment point for mounting a fall protection

Article No.	EAN 4003773	↔ mm	1000 V	Pliers	Head	Handles	Cutting capacities				
							Ø mm	Ø mm	Ø mm	mm ²	g
08 26 145	079361	145	1000 V	chrome plated	chrome plated	insulated with multi-component grips, VDE-tested	3.0	2.0	8.0	16	145
08 26 145 T	081401	145	1000 V	chrome plated	chrome plated	insulated with multi-component grips with integrated insulated tether attachment point, VDE tested	3.0	2.0	8.0	16	155

Insulation Strippers

universal

- > For single, multiple and fine stranded conductors with plastic or rubber insulation up to 5.0 mm dia. or 10 mm² cable cross-section
- > Easy adjustment to the required diameter of solid or stranded wire with knurled screw and lock nut
- > Special tool steel, forged, oil-hardened
- > DIN EN 60900, IEC 60900



11 06 160



11 07 160

11 06 160 T

- > Pliers with tether attachment point for mounting a fall protection

Article No.	EAN 4003773-	↔ mm	1000 V	Pliers	Head	Handles	Stripping capacities			g
							Ø mm	mm ²	AWG	
11 06 160	021933	160	1000 V	chrome plated	chrome plated	insulated with multi-component grips, VDE-tested	5.0	10	7	200
11 06 160 T	081418	160	1000 V	chrome plated	chrome plated	insulated with multi-component grips with integrated insulated tether attachment point, VDE tested	5.0	10	7	180
11 07 160	015499	160	1000 V	chrome plated	chrome plated	with dipped insulation, VDE-tested	5.0	10	7	180
11 17 160	015505	160	1000 V	chrome plated	chrome plated	with dipped insulation, VDE-tested	5.0	10	7	181
11 09 01	052326	Set of spare parts (screw and nut) for 11 160								

KNIPEX StriX®

Insulation strippers with Cable Shears – two essential electrical installation tools in one pair of pliers

- > Integrated Cable Shears for the clean cutting of Cu and Al cables without crushing
- > Universal adjustment of the wire stripping blades by means of a knurled screw
- > Slim design for good accessibility
- > For stripping single, multiple and fine stranded conductors with plastic and rubber insulation up to a max. Ø 5 mm or resp. 10 mm² conductor cross-section
- > Graduated jaw provides a visual orientation aid when stripping wire in standard lengths (11 mm and 16 mm)
- > Special high grade tool steel that has been oil-hardened in multiple stages

13 66 180 T*

- > Pliers with tether attachment point for mounting a fall protection



13 66 180



13 66 180 T

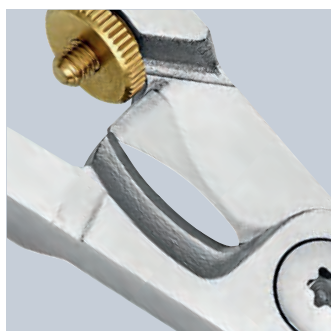

Induction hardened precision blade

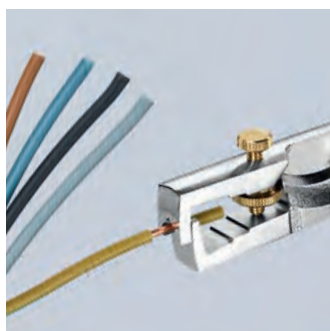

Length marking: visual markings provide support during repeated stripping of wire in standard lengths (11 and 16 mm)



Induction hardened shear blade with precisely ground cutting edges for crushing-free cutting of copper cables up to Ø 15 mm (5 x 2.5 mm²)

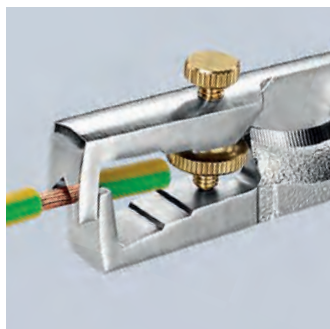

Lock nut prevents any unintentional adjustment



Article No.	EAN 4003773-	↔ mm	Pliers	Head	Handles	Cutting capacities		Stripping capacities		⚖ g
						Ø mm	mm ²	Ø mm	mm ²	
13 62 180	081302	180	black atramentized	polished	with multi-component grips	15	50	5.0	10	210
13 66 180	081319	180	chrome plated		insulated with multi-component grips, VDE-tested	15	50	5.0	10	210



Stripping Pliers

Multifunctional – cutting and stripping with one pair of pliers

- ▶ For time-saving stripping of all round sheathed and damp-proof installation cables (e.g. NYM cable)
 - ▶ Simplified access especially into deep mounted junction boxes thanks to slim head design and optimally angled cable sheath cutter
 - ▶ Strip cables easily and without damage thanks to circular cutting edge with depth limiter
- > Suitable for universal use: precision wire stripping holes for conductors from 1.5 and 2.5 mm²
- > With side cutters for cutting and trimming conductors, wires, small screws and nails
- > All cutters additionally induction-hardened to approx. 61 HRC for high wear resistance
- > 30 % lighter than comparable pliers
- > Vanadium electric steel, forged, multi stage oil-hardened
- > DIN EN 60900, IEC 60900



13 46 165

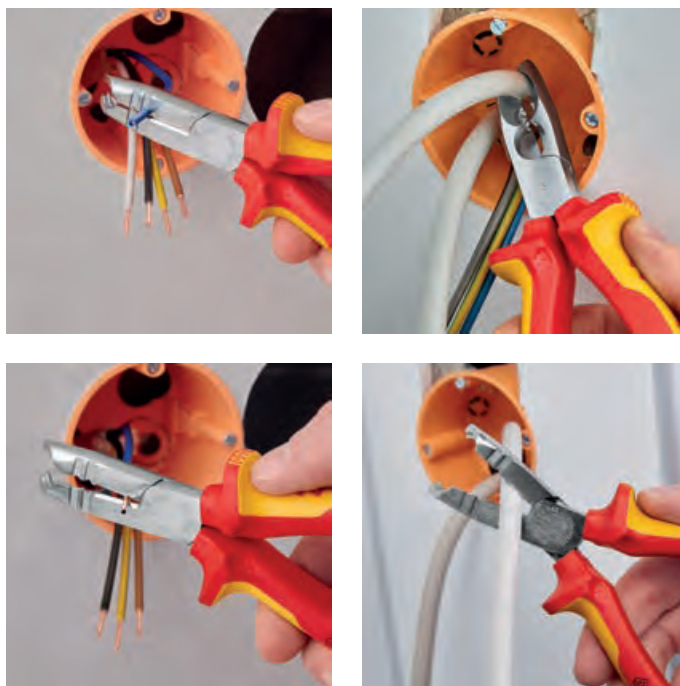

Article No.	EAN 4003773-	↔ mm		Pliers	Head	Handles	Cable stripping values Ø mm	Stripping capacities mm ²	⊙ Ø mm	⊙ Ø mm	⚖ g
13 46 165	079699	165		chrome plated	chrome plated	insulated with multi-component grips, VDE-tested	8.0 - 13.0	0.75 - 1.5 / 2.5	3.2	2.2	190

Diagonal Insulation Strippers

- ▶ With long cutter
 - ▶ High cutting capacity due to high leverage joint
- > Precision stripping holes for single conductors of 1.5 and 2.5 mm²
- > Convenient cutting of NYM cables up to 5 x 2.5 mm²
- > Long tips for ultra fine cutting work also in confined areas
- > Induction-hardened precision blades, cutting edge hardness approx. 60 HRC
- > Vanadium electric steel, forged, multi stage oil-hardened
- > DIN EN 60900, IEC 60900



14 26 160



Article No.	EAN 4003773-	↔ mm		Pliers	Head	Handles	Stripping capacities mm ²	AWG	Cutting capacities		⚖ g
									⊙ Ø mm	⊙ Ø mm	
14 26 160	040279	160		chrome plated	chrome plated	insulated with multi-component grips, VDE-tested	1.5 / 2.5	15 / 13	2.5	1.5	216

Round Nose Pliers

- > For bending wire loops
- > Round, short jaws; finely ground
- > Smooth tips
- > Special tool steel, forged, oil-hardened
- > DIN ISO 5745, DIN EN 60900, IEC 60900

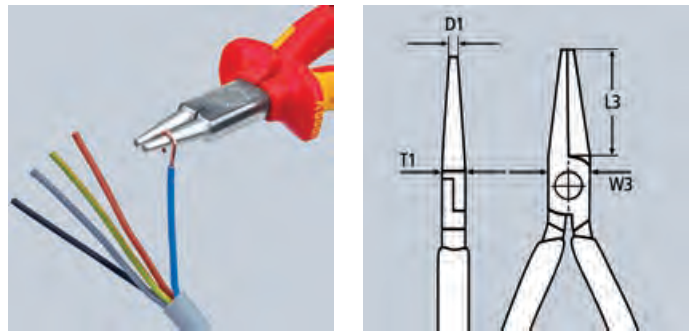

22 06 160

Article No.	EAN 4003773-	↔ mm	Pliers	Head	Handles	Dimensions				⚖ g	
						L3 mm	W3 mm	D1 mm	T1 mm		
22 06 160	033790	160	8	chrome plated	chrome plated	insulated with multi-component grips, VDE-tested	30.0	18.0	3.0	9.5	175

Pliers for Electrical Installation

The all-rounder for professionals

- ▶ 6 functions in one pair of pliers
- ▶ Multifunctional pliers for the electrical installation; to grip flat and round material, for bending, deburring, cutting cable, stripping and crimping wire ferrules
- > Smooth surfaces near the tips grip single cores without damaging them; serrated gripping surfaces and pipe grip for gripping flat and round material
- > Clear-cut outside edge on the jaw for working on flush-mounted junction boxes and deburring feed-through holes
- > Stripping holes for conductors of 0.75 - 1.5 mm² and 2.5 mm²
- > Crimping die for wire ferrules 0.5 - 2.5 mm²
- > Cable shears with (induction-hardened) precision cutting edges for copper and aluminium cables up to 5 x 2.5 mm² / dia. 15 mm
- > Slim dimensions for easy access
- > Bolted joint: precise, zero backlash operation of pliers
- > High-grade special tool steel, forged, multi stage oil-hardened
- > DIN EN 60900, IEC 60900



13 86 200

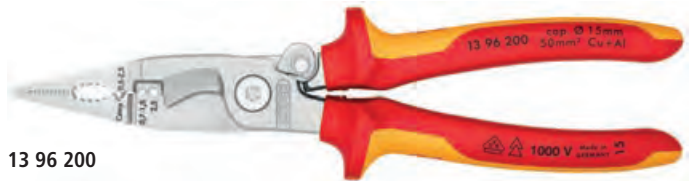

13 96 200



13 96 200 T



13 96 200

- > In case of models with opening spring integrated in the joint, the activated locking lever keeps the cutting edges closed while other functions remain active; the intelligent latching mechanism enables you to "grip" without opening the pliers. The cutting edge remains closed and protected

13 96 200 T*

- > Pliers with tether attachment point for mounting a fall protection

Article No.	EAN 4003773-	↔ mm	Pliers	Head	Handles	Cutting capacities		Stripping capacity for cross-sections mm ²	Crimping capacities mm ²	⚖ g
						Ø mm	mm ²			
13 86 200	075097	200	chrome plated	chrome plated	insulated with multi-component grips, VDE-tested	15.0	50	0.75 - 1.5 / 2.5	0.5 - 2.5	280
13 96 200	075110	200	chrome plated	chrome plated	insulated with multi-component grips, VDE-tested	15.0	50	0.75 - 1.5 / 2.5	0.5 - 2.5	280
13 96 200 T	081425	200	chrome plated	chrome plated	insulated with multi-component grips with integrated insulated tether attachment point, VDE tested	15.0	50	0.75 - 1.5 / 2.5	0.5 - 2.5	275

Flat Nose Pliers

- > Flat, short, wide jaws
- > Knurled gripping surfaces
- > Special tool steel, forged, oil-hardened
- > DIN ISO 5745, DIN EN 60900, IEC 60900

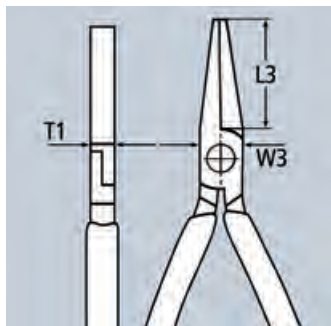

20 06 160

Article No.	EAN 4003773-	↔ mm		Pliers	Head	Handles	Dimensions			 g
							L3 mm	W3 mm	T1 mm	
20 06 160	033783	160		chrome plated	chrome plated	insulated with multi-component grips, VDE-tested	30.0	17.0	9.5	176

Snipe Nose Side Cutting Pliers

Radio Pliers

- > Suitable for finer gripping and cutting work
- > Half-round, long, tapered jaws
- > Knurled gripping surfaces
- > With cutting edges for soft, medium-hard and hard wire
- > Cutting edges additionally induction-hardened, cutting edge hardness approx. 61 HRC
- > Vanadium electric steel, forged, multi stage oil-hardened
- > DIN ISO 5745, DIN EN 60900, IEC 60900



25 06 160



25 26 160



Article No.	EAN 4003773-	↔ mm		Pliers	Head	Handles	Cutting capacities		 g
							 Ø mm	 Ø mm	
25 06 160	033806	160		chrome plated	chrome plated	insulated with multi-component grips, VDE-tested	2.5	1.6	146
25 06 160 T	081432	160		chrome plated	chrome plated	insulated with multi-component grips, VDE-tested, with integrated insulated tether attachment point for a tool tether	2.5	1.6	155
25 26 160	052111	160		chrome plated	chrome plated	insulated with multi-component grips, VDE-tested	2.5	1.6	144

Snipe Nose Side Cutting Pliers

Stork Beak Pliers

► Elastic tips: dimensionally stable even when twisted

- > Distortion-tolerant, elastic precision tips
- > Half-round, long, tapered jaws
- > With cutting edges (hardness approx. 61 HRC) for soft, medium-hard and hard wire
- > Vanadium electric steel, forged, multi stage oil-hardened
- > DIN ISO 5745, DIN EN 60900, IEC 60900

26 16 200 T / 26 26 200 T*

> Pliers with tether attachment point for mounting a fall protection

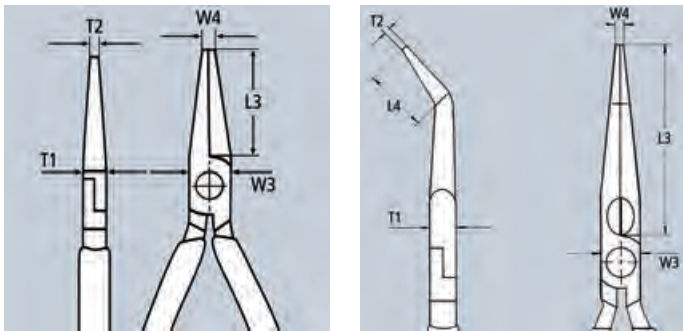
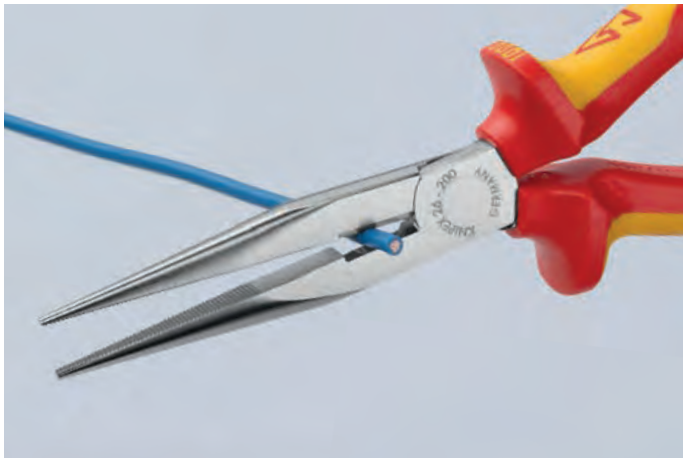

Article No.	EAN 4003773-	↔ mm		Pliers	Head	Handles	Cutting capacities		Dimensions						
							 Ø mm	 Ø mm	L3 mm	L4 mm	W3 mm	T1 mm	W4 mm	T2 mm	 g
26 16 200	022831	200		chrome plated	chrome plated	insulated with multi-component grips, VDE-tested	3.2	2.2	73.0		18.0	9.5	3.0	2.5	206
26 16 200 T	081449	200		chrome plated	chrome plated	insulated with multi-component grips with integrated insulated tether attachment point, VDE tested	3.2	2.2	73.0		18.0	9.5	3.0	2.5	215
26 17 200	016069	200		chrome plated	chrome plated	with dipped insulation, VDE-tested	3.2	2.2	73.0		18.0	9.5	3.0	2.5	212
26 26 200	022855	200		chrome plated	chrome plated	insulated with multi-component grips, VDE-tested	3.2	2.2	73.0	23.0	18.0	9.5	3.0	2.5	204
26 26 200 T	081456	200		chrome plated	chrome plated	with multi-component grips and integrated tether attachment point	3.2	2.2	73.0	23.0	18.0	9.5	3.0	2.5	215
26 27 200	016090	200		chrome plated	chrome plated	with dipped insulation, VDE-tested	3.2	2.2	73.0	23.0	18.0	9.5	3.0	2.5	220

Long Nose Pliers

- > Heavy duty and wear resisting
- > Different jaw styles
- > Chrome vanadium electric steel, forged, oil-hardened
- > DIN ISO 5745, DIN EN 60900, IEC 60900

Style 1

- > Long, trapezoidal jaws; knurled gripping surfaces

Style 3

- > Long, round jaws; smooth gripping surfaces

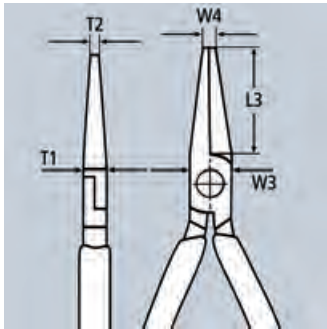

30 16 160



30 36 160

Article No.	EAN 4003773-	↔ mm		Style	Pliers	Head	Handles	Dimensions					Δ g
								L3 mm	W3 mm	T1 mm	W4 mm	T2 mm	
30 16 160	001904	160		1	chrome plated	chrome plated	insulated with multi-component grips, VDE-tested	46.5	16.5	9.5	3.0	5.0	150
30 36 160	002123	160		3	chrome plated	chrome plated	insulated with multi-component grips, VDE-tested	41.0	16.5	9.5	5.0	2.5	141

Diagonal Cutters

- > The indispensable diagonal cutter for all-round use
- > High-quality material and precise workmanship for long service life
- > Precision cutting edges for soft and hard wire
- > Clean cutting of thin copper wires, also at the cutting edge tips
- > Cutting edges additionally induction-hardened, cutting edge hardness approx. 62 HRC
- > Narrow head style for use in confined areas
- > Vanadium electric steel, forged, multi stage oil-hardened
- > DIN ISO 5749, DIN EN 60900, IEC 60900

70 06 160 T / 70 06 180 T*

- > Pliers with tether attachment point for mounting a fall protection



70 06 160



70 06 160 T



70 06 180



70 07 180



70 26 160



Clean cutting of thin copper wires, also at the cutting edge tips

Article No.	EAN 4003773-	↔ mm	Icons	Pliers	Head	Handles	Cutting capacities			
							Ø mm	Ø mm	Ø mm	g
70 06 125	018124	125	1000V, IEC 60900	chrome plated	chrome plated	insulated with multi-component grips, VDE-tested	3.0	2.3	1.5	121
70 06 140	040293	140	1000V, IEC 60900	chrome plated	chrome plated	insulated with multi-component grips, VDE-tested	4.0	2.5	1.8	160
70 06 160	021995	160	1000V, IEC 60900	chrome plated	chrome plated	insulated with multi-component grips, VDE-tested	4.0	3.0	2.0	216
70 06 160 T	081463	160	1000V, IEC 60900	chrome plated	chrome plated	insulated with multi-component grips with integrated insulated tether attachment point, VDE tested	4.0	3.0	2.0	230
70 06 180	033813	180	1000V, IEC 60900	chrome plated	chrome plated	insulated with multi-component grips, VDE-tested	4.0	3.0	2.5	254
70 06 180 T	081470	180	1000V, IEC 60900	chrome plated	chrome plated	insulated with multi-component grips with integrated insulated tether attachment point, VDE tested	4.0	3.0	2.5	270
70 07 160	018155	160	1000V, IEC 60900	chrome plated	chrome plated	with dipped insulation, VDE-tested	4.0	3.0	2.0	227
70 07 180	018179	180	1000V, IEC 60900	chrome plated	chrome plated	with dipped insulation, VDE-tested	4.0	3.0	2.5	269
70 26 160	018223	160	1000V, IEC 60900	chrome plated	chrome plated	insulated with multi-component grips, VDE-tested	4.0			216

KNIPEX X-Cut®

Compact Diagonal Cutters

high lever transmission

- ▶ Cuts finest strands as well as multi-core cables and piano wires
- ▶ Powerful, light and universal
- > High cutting performance with minimum effort due to optimum co-ordination of the cutting edge angle and transmission ratio
- > Box-joint design: highest stability with low weight
- > Doubly supported joint axis for heavy duty
- > Large opening width for thicker cables
- > Cuts precisely, even through fine copper wires
- > Compact, low-weight construction
- > Universally usable, in the assembly, maintenance and production
- > 40 % less force required compared with standard diagonal cutters of the same length
- > Chrome vanadium heavy-duty steel, forged, multi stage oil-hardened
- > DIN ISO 5749, DIN EN 60900, IEC 60900

73 06 160 T*

- > Pliers with tether attachment point for mounting a fall protection



73 06 160



73 06 160 T

40 % less effort

required compared to diagonal cutters of the same length. With double mounted hinged joint.

Article No.	EAN 4003773-	↔ mm	Icons	Pliers	Head	Handles	Cutting capacities					Δ g
							Ø mm	Ø mm	Ø mm	Ø mm	Ø mm	
73 06 160	075141	160	Icons	chrome plated	chrome plated	insulated with multi-component grips, VDE-tested	4.8	3.8	2.7	2.2	12.0	175
73 06 160 T	081487	160	Icons	chrome plated	chrome plated	insulated with multi-component grips with integrated insulated tether attachment point, VDE tested	4.8	3.8	2.7	2.2	12.0	185

High Leverage Diagonal Cutters

- > For very tough, continuous use
- > High cutting performance with minimum effort due to optimum co-ordination of the cutting edge angle and transmission ratio
- > Precision cutting edges additionally induction-hardened (cutting edge hardness approx. 64 HRC), for all sorts of wire including piano wire
- > Chrome vanadium heavy-duty steel, forged, multi stage oil-hardened
- > DIN ISO 5749, DIN EN 60900, IEC 60900

74 06 250 T*

- > Pliers with tether attachment point for mounting a fall protection



74 06 200



74 06 200 T

20 % less effort

Required compared to high-leverage diagonal cutters of the same length. With integrated forged joint axle.

Article No.	EAN 4003773-	↔ mm	Icons	Pliers	Head	Handles	Cutting capacities			Δ g
							Ø mm	Ø mm	Ø mm	
74 06 160	040705	160					3.4	2.5	2.0	215
74 06 180	022985	180					3.8	2.7	2.2	280
74 06 200	033820	200	Icons	chrome plated	chrome plated	insulated with multi-component grips, VDE-tested	4.2	3.0	2.5	304
74 06 250	041955	250					4.6	3.5	3.0	453
74 06 200 T	081494	200	Icons	chrome plated	chrome plated	insulated with multi-component grips with integrated insulated tether attachment point, VDE tested	4.2	3.0	2.5	305
74 06 250 T	081500	250	Icons	chrome plated	chrome plated	insulated with multi-component grips with integrated insulated tether attachment point, VDE tested	4.6	3.5	3.0	465
74 07 200	018414	200	Icons	chrome plated	chrome plated	with dipped insulation, VDE-tested	4.2	3.0	2.5	328
74 07 250	018421	250	Icons	chrome plated	chrome plated	with dipped insulation, VDE-tested	4.6	3.5	3.0	510

Pliers Wrenches

Pliers and a wrench in a single tool

- ▶ Replaces the need for sets of metric and imperial spanners
 - ▶ Smooth jaws for damage free installation of plated fittings – working directly on chrome!
 - ▶ Practical adjustment scale: A laser-cut (metric and imperial) enables pre-setting to the width across flats
- > Also excellent for gripping, holding, pressing and bending workpieces
 - > Zero backlash jaw pressure prevents damage to edges of sensitive components
 - > Fast adjustment by pushing a button directly on the workpiece
 - > No unintentional shift of the gripping jaws and no slipping of the joint
 - > Parallel jaws give a more solid grip; its design allows flexible adjustment of all widths up to the specified maximum size
 - > The ratchet type principle allows quick and easy tightening and release of all bolted connections
 - > Lever transmission greater than 10 : 1 for strong gripping power
 - > Chrome vanadium electric steel, forged, oil-hardened
 - > DIN EN 60900, IEC 60900



86 06 250

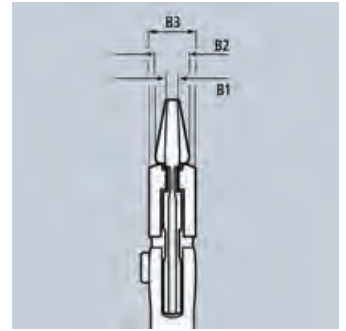

Article No.	EAN 4003773-	↔ mm	1000 V	Pliers	Handles	⊘ Inch	⊘ mm	Adjustment positions	Dimensions			⚖ g
									B1 mm	B2 mm	B3 mm	
86 06 250	082408	250	1000 V	chrome plated	insulated with multi-component grips, VDE-tested	2	52.0	19	8.0	8.0	14.0	525

KNIPEX Alligator®

Water Pump Pliers

- ▶ Good access to the workpiece due to slim size of head and joint area
 - ▶ More output and comfort compared to conventional water pump pliers of the same length: 9-notch adjustment positioning for 30 % more gripping capacity
- > Self-locking on pipes and nuts: no slipping on the workpiece and low handforce required
 - > Gripping surfaces with special hardened teeth, teeth hardness approx. 61 HRC: high wear resistance and stable gripping
 - > Box-joint design for high stability due to double guide
 - > Robust construction, insensitive to dirt; particularly suitable for outdoor work
 - > Pinch guard prevents operators' fingers being pinched
 - > Chrome vanadium electric steel, forged, multi stage oil-hardened
 - > DIN ISO 8976, DIN EN 60900, IEC 60900



88 06 250



88 07 250



Article No.	EAN 4003773-	↔ mm	1000 V	Pliers	Head	Handles	⊘ Inch	⊘ mm	⊘ mm	Adjustment positions	⚖ g
88 07 250	019343	250	1000 V	chrome plated	chrome plated	with dipped insulation, VDE-tested	2	50.0	46.0	9	420
88 07 300	022350	300	1000 V	chrome plated	chrome plated		2 3/4	70.0	60.0	9	661

KNIPEX Cobra® VDE

Hightech Water Pump Pliers, insulated

- > Adjustment by shifting one jaw directly on to the workpiece: fast, reliable and comfortable handling
- > Fine adjustment: allows optimum adjustment to differently sized workpieces and comfortable handle position
- > Good access to the workpiece due to slim size of head and joint area
- > Self-locking on pipes and nuts: no slipping on the workpiece and low handforce required
- > Gripping surfaces with special hardened teeth, teeth hardness approx. 61 HRC: high wear resistance and stable gripping
- > Box-joint design for high stability due to double guide
- > Pinch guard prevents operators' fingers being pinched
- > Chrome vanadium electric steel, forged, multi stage oil-hardened
- > DIN ISO 8976, DIN EN 60900, IEC 60900

87 26 250 T*

- > Pliers with tether attachment point for mounting a fall protection



87 26 250



87 26 250 T

The adjustment action to adapt to the workpiece is easy and reliable with the KNIPEX Cobra® VDE: place the upper gripping jaw of the opened pliers on the workpiece, push pliers to close, done!



Quick setting without using a push-button

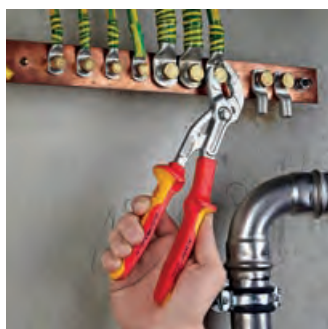

Just push the pliers handle to adjust!

Article No.	EAN	↔ mm		Pliers	Head	Handles	⊘ Inch	⊘ mm	⬡ mm	Adjustment positions	⚖ g
87 26 250	071495	250		chrome plated	chrome plated	insulated with multi-component grips, VDE-tested	2	50.0	46.0	24	340
87 26 250 T	081517	250		chrome plated	chrome plated	insulated with multi-component grips, VDE-tested with integrated insulated tether attachment point for a tool tether	2	50.0	46.0	24	400
87 29 01	079002	range of spare parts for 87 2x-250									

*Other tools with tethering can be found from page 266

Precision Tweezers

insulated

- > With dipped insulation
- > Spring steel, high-strength
- > DIN EN 60900, IEC 60900

92 27 61

- > For ultra fine mounting work; extra fine tips; straight pattern; gripping surfaces matt finished for optimum grip

92 27 62

- > Straight pattern; gripping surfaces with fine transverse serration

92 37 64

- > Angled tips; gripping surfaces with fine transverse serration

92 67 63

- > Straight pattern; knurled gripping surfaces



92 27 61



92 27 62



92 37 64



92 67 63

Article No.	EAN 4003773-	↔ mm		Finish	⚖ g
92 27 61	054757	130	1000 V	with dipped insulation	30
92 27 62	054764	150	1000 V	with dipped insulation	35
92 37 64	054856	150	1000 V $\angle 45^\circ$	with dipped insulation	34
92 67 63	054931	145	1000 V	with dipped insulation	40

Cable Shears

handles extrusion plastic-coated

- > Not suitable for steel wire and hard drawn copper conductors
- > Precision-ground, hardened blades
- > No crushing, slight deformation of the cable only
- > Adjustable bolted joint
- > Shears body: surgical steel, stainless, vacuum-hardened
- > Handles: plastic, impact-proof
- > DIN EN 60900, IEC 60900



95 06 230

Article No.	EAN 4003773-	↔ mm		Head	Handles	Cutting capacities		AWG	⚖ g
						⊕ Ø mm	⊕ mm ²		
95 06 230	006305	230	1000 V	polished	plastic insulated, VDE-tested	16.0	50	1 / 0	274

Cable Shears

- > For cutting copper and aluminium single conductors as well as multiple stranded cables
- > Clean and smooth cut without crushing and deformation
- > Not suitable for steel wire and hard drawn copper conductors
- > Precision-ground, hardened blades
- > Easy cutting with one-hand operation
- > With guard
- > Adjustable bolted joint, self-retaining screw
- > High-grade special tool steel, forged, oil-hardened
- > DIN EN 60900, IEC 60900

95 16 165 T*

- > Pliers with tether attachment point for mounting a fall protection



95 16 165



95 26 165



Cutting a cable with a conventional wire cutter. High force is required, and the cable is squeezed and deformed.



Cut performed with a Cable Shear: easy, clean cut without any deformation of the cable



95 26 165: Catch locks shears to the opening spring inside



Article No.	EAN 4003773-	↔ mm	Safety icons	Tool	Handles	Cutting capacities			⚖ g
						⊘ mm	mm ²	AWG	
95 16 165	039648	165	⚡ 1000V	chrome plated	insulated with multi-component grips, VDE-tested	15.0	50	1 / 0	262
95 16 165 T	081524	165	⚡ 1000V	chrome plated	insulated with multi-component grips with integrated insulated tether attachment point, VDE tested	15.0	50	1 / 0	260
95 26 165	069980	165	⚡ 1000V	chrome plated	insulated with multi-component grips, VDE-tested	15.0	50	1 / 0	275

Cable Shears

with twin cutting edge

- > For cutting copper and aluminium cables
- > Not suitable for steel wire and hard drawn copper conductors
- > Precision-ground, hardened blades
- > Clean and smooth cut without crushing and deformation
- > Adjustable bolted joint, self-retaining screw
- > Low handforce required due to favourable lever ratio and special blade geometry
- > Pinch guard prevents operators' fingers being pinched
- > By dividing the cutting actions into initial cut (insulating sheath in the front cutting area) and final cut (conductor in the back cutting area), cables up to Ø 20 mm can be cut in one-hand operation
- > High-grade special tool steel, forged, oil-hardened
- > DIN EN 60900, IEC 60900



95 16 200



Initial cut: using the front cutting edge to cut the insulating sheath on larger cable diameters leaves an ergonomic handle opening width.



Final cut: after cutting the sheath in the front profile the conductors in the rear part are cut. Initial cut in the front profile, final cut in the rear profile – to keep it as easy as possible.

Article No.	EAN 4003773-	↔ mm	Safety icons	Tool	Handles	Cutting capacities			⚖ g
						⊘ mm	mm ²	AWG	
95 16 200	026761	200	⚡ 1000V	chrome plated	insulated with multi-component grips, VDE-tested	20.0	70	2 / 0	340
95 17 200	026952	200	⚡ 1000V	chrome plated	with dipped insulation, VDE-tested	20.0	70	2 / 0	360

*Other tools with tethering can be found from page 266

Cable Shears

for two-handed use, short construction

- ▶ Short design, length only 500 mm
- ▶ Low weight, high leverage

- > For cutting copper and aluminium single conductors as well as multiple stranded cables
- > Not suitable for steel wire and wire ropes
- > Precision-ground, hardened blades
- > Clean and smooth cut without crushing and deformation
- > Low handforce required due to favourable lever ratio and special blade geometry
- > Pinch guard prevents operators' fingers being pinched
- > Adjustable bolted joint
- > Cutter head: vanadium electric steel, forged, oil-hardened
- > Handles: aluminium tube, high-strength
- > DIN EN 60900, IEC 60900



95 17 500



Large cutting capacity:
max. 27 mm dia. / 150 mm²

Article No.	EAN 4003773-	↔ mm		Head	Handles	Cutting capacities			⚖ g
						Ø mm	mm ²	AWG	
95 17 500	026785	500	⚡ 1000V	polished	with dipped insulation, VDE-tested	27.0	150	5 / 0	1477

Cable Shears

for two-hand operation

- > For cutting copper and aluminium single conductors as well as multiple stranded cables
- > Not suitable for steel wire and wire ropes
- > Precision-ground, hardened blades
- > Clean and smooth cut without crushing and deformation
- > Favourable lever ratio due to toggle lever
- > Pinch guard prevents operators' fingers being pinched
- > Adjustable bolted joint
- > Bolted cutter head, replaceable
- > Handles: steel tube
- > Cutter head: high-grade chrome vanadium electric steel, forged, oil-hardened
- > DIN EN 60900, IEC 60900



95 27 600

Article No.	EAN 4003773-	↔ mm		Head	Handles	Cutting capacities			⚖ g
						Ø mm	mm ²	AWG	
95 27 600	021797	600	⚡ 1000V	polished	with dipped insulation, VDE-tested	27.0	150	5 / 0	2262
95 29 600	021803	Spare cutter head for 95 21 600 / 95 27 600							

Cable Cutters

(ratchet action)

- > For cutting copper and aluminium single conductors as well as multiple stranded cables
- > Not suitable for steel wire and wire ropes
- > Precision-ground, hardened blades
- > Clean and smooth cut without crushing and deformation
- > One-hand operation using ratchet principle
- > Little handforce required due to very high transmission ratio
- > Two-stage ratchet drive for easy cutting
- > Simple handling as a result of low weight and compact design – can be used even in confined areas
- > Pinch guard prevents operators' fingers being pinched
- > High-grade special tool steel, forged, oil-hardened
- > DIN EN 60900, IEC 60900

95 36 280

- > Suitable for aluminium sector cable up to 4 x 150 mm²



95 36 250



95 36 280



Ratchet principle and two-stage ratchet drive for easier cutting



Article No.	EAN 4003773-	↔ mm	1000 V	Tool	Handles	Cutting capacities		MCM	 g
						Ø mm	mm ²		
95 36 250	026884	250	1000 V	black lacquered	insulated with multi-component grips, VDE-tested	32.0	240	500	652
95 36 280	026891	280	1000 V	black lacquered	insulated with multi-component grips, VDE-tested	52.0	380	750	835
95 39 04	039167	Feed pawl 95 3 250/280							
95 39 08 S	039211	Tension spring set for lateral mounting 95 36 25/28							
95 39 250	022244	Movable spare blade for 95 31 250 / 95 36 250							
95 39 280	025283	Movable spare blade for 95 31 280 / 95 36 280							

Cable Cutters

(ratchet principle, 3-stage)

- ▶ Sturdy. Easy to use. Stable.
- ▶ Innovative ratchet-drive.
- ▶ For cable up to 60 mm diameter.

- > Fixed handle with support area for putting down the pliers when cutting
- > Easy handling due to low weight (825 g) and compact construction (320 mm length) – also usable in confined areas
- > Cutting through copper and aluminium cables with diameters of up to 60 mm in one-hand and two-hand operation
- > Hardened cutting edges, precisely ground, cut smoothly and neatly without crushing
- > For cutting copper and aluminium single conductors as well as multiple stranded cables (not suitable for steel wire and wire ropes)
- > Innovative three-stage ratchet-drive with high leverage for easy cutting in one-hand and two-hand operation
- > High-grade special tool steel, forged, oil-hardened
- > DIN EN 60900, IEC 60900



95 36 320

Article No.	EAN 4003773-	↔ mm		Tool	Head	Handles	Cutting capacities			
							Ø mm	mm ²	MCM	g
95 36 320	075189	320	1000V	black atramentized	polished	insulated with multi-component grips, VDE-tested	60.0	600	1200	830
95 39 320 01	075714	Pivot cutter repair kit for 95 32 320 and 95 36 320								
95 39 320 02	075721	Fixed cutter repair kit for 95 32 320 and 95 36 320								

Cable Cutters

(ratchet action)

for steel wire armoured cables (SWA cable)

- ▶ Cuts through steel wire armoured cables with a diameter of up to 45 mm / 380 mm² (e.g. 4 x 95 mm²) using one or two-handed operation
- ▶ Sturdy. Easy to use. Stable.

- > Simple handling due to low weight (800 g) and compact design (315 mm length) – can also be used in confined areas
- > Precision-ground blades and induction-hardened cutting edges cut smoothly and neatly without crushing
- > Innovative high leverage three-stage ratchet-drive
- > Support area for putting down the pliers when cutting
- > Not suitable for cutting ACSR cable and wire rope!
- > Cutter head: special high-grade tool steel, forged, oil-hardened
- > IEC 60900, DIN EN 60900



95 36 315 A



Article No.	EAN 4003773-	↔ mm		Tool	Handles	Cutting capacities				
						Ø mm	mm ²	MCM	g	
95 36 315 A	078579	315	1000V	black lacquered	insulated with multi-component grips, VDE-tested	45.0	380	750	800	
95 39 315 A01	078586	Pivot cutter repair kit for 95 32 315 A and 95 36 315 A								

Wire Rope and ACSR-Cable Cutters

Handles: aluminium, high-strength

- > For wire ropes and steel rods, copper and aluminium cables
- > Suitable for cutting overhead cables with strain relief wire (ACSR-cables)
- > Angular cutting blades allow cutting of single rope wire
- > Optimum transmission ratio for high cutting performance
- > Bolted cutter head, replaceable
- > Low weight
- > Handles: aluminium, high-strength
- > Cutter head: high-grade special tool steel, multi stage oil-hardened
- > DIN EN 60900, IEC 60900



95 77 600



Article No.	EAN 4003773-	↔ mm		Head	Handles	Cutting capacities			AWG	⚖ g
						⊕ mm ²	⊙ Ø mm	◐ Ø mm		
95 77 600	025313	600	⚡ 1000V	polished	with dipped insulation	150	14.0	9.0	5 / 0	2359
95 79 600	025337	Spare cutter head for 95 71 600 / 95 77 600								

Crimping Pliers for wire ferrules with trapezoid crimp

- > For crimping wire ferrules according to DIN 46228 parts 1 + 4 in the range from 0.25 up to 2.5 mm²
- > Crimping in marked trapezoidal dies for reliable connections between the sleeve and the conductor
- > Vanadium electric steel; forged, oil-hardened
- > DIN EN 60900, IEC 60900



97 68 145 A

Article No.	EAN 4003773-	↔ mm			Head	Handles	Capacity mm ²	AWG	△ g
97 68 145 A	071754	145			⚠ 1000 V	polished insulated with multi-component grips, VDE-tested	0.25 - 2.5	23 - 13	175

Crimping Pliers for wire ferrules with mandrel crimp

- ▶ Light and slim design
- ▶ Easy crimping due to optimised transmission ratio

- > For crimping wire ferrules according to DIN 46228 parts 1 + 4 from 0.25 to 16 mm²
- > Crimping in marked half-round dies for reliable connections between the sleeve and the conductor
- > 9 particularly deep dies with conical side faces
- > Special tool steel, forged, oil-hardened
- > DIN EN 60900, IEC 60900

97 78 180 T*

- > Pliers with tether attachment point for mounting a fall protection



97 78 180



97 78 180 T



Article No.	EAN 4003773-	↔ mm			Head	Handles	Applications	Capacity mm ²	AWG	△ g
97 78 180	072003	180			⚠ 1000 V	polished insulated with multi-component grips, VDE-tested	Wire ferrules	0.25 - 16	23 - 5	254
97 78 180 T	081531	180			⚠ 1000 V	polished insulated with multi-component grips, VDE-tested with integrated insulated tether attachment point for a tool tether	Wire ferrules	0,25 - 16	23 - 5	260

Open-end wrenches

- > Jaw 15° angled
- > Basic tool chrome plated
- > Chrome vanadium steel, forged, oil-hardened
- > DIN EN 60900, IEC 60900



98 00 14



Article No.	EAN 4003773-		Width across flats S mm	Width across flats S Inch	Length l max. mm	Head width b max. mm mm	Head thickness a max. mm	△ g
98 00 07	019824	△ 1000 V	7.0		105.0	20.0	4.0	15
98 00 08	019831		8.0		105.0	22.0	4.0	31
98 00 09	019848		9.0		105.0	24.0	4.0	29
98 00 10	019893		10.0		105.0	27.0	5.0	46
98 00 11	019909		11.0		120.0	30.0	5.5	45
98 00 12	019923		12.0		125.0	32.0	5.5	70
98 00 13	019930		13.0		130.0	34.0	6.5	68
98 00 14	019947		14.0		135.0	35.0	6.5	86
98 00 15	019954		15.0		145.0	37.0	7.0	80
98 00 16	019961		16.0		155.0	38.0	7.0	112
98 00 17	019978		17.0		155.0	42.0	8.0	119
98 00 18	019985		18.0		160.0	44.0	8.0	149
98 00 19	019992		19.0		165.0	47.0	9.0	154
98 00 22	020004		22.0		190.0	52.0	9.0	216
98 00 24	020011		24.0		210.0	56.0	9.0	290
98 00 27	020028		27.0	1	215.0	63.0	9.0	307
98 00 1/4"	019886				108.0	20.0	4.0	32
98 00 5/16"	020073				108.0	22.0	4.0	36
98 00 3/8"	020042				108.0	27.0	5.0	37
98 00 7/16"	020097				120.7	30.0	5.5	53
98 00 1/2"	019879				139.7	34.0	6.5	70
98 00 9/16"	020110				152.4	35.0	6.5	102
98 00 5/8"	020080				165.1	38.0	7.0	124
98 00 3/4"	020035				190.5	47.0	9.0	164



Adjustable Wrench

- > Parallel smooth gripping jaws
- > Variable gripping width
- > With scaling for presetting the width apart from the workpiece
- > Chrome Vanadium steel
- > DIN EN 60900, IEC 60900



98 07 250



Article No.	EAN 4003773	↔ mm		Tool	Handle	⬡ mm	⬡ Inch	Jaw width mm	Head width mm	Width mm	Depth mm	⚖ g
98 07 250	071518	260	⚡ 1000 V ∠22°	chrome plated	with dipped insulation	34.0	1 1/8	8.0	16.0	57.0	20.0	590

Box Wrenches

- > Cranked
- > Basic tool chrome plated
- > Chrome vanadium steel, forged, oil-hardened
- > DIN EN 60900, IEC 60900



98 01 14



Article No.	EAN 4003773-		Width across flats S mm	Length l max. mm	Head width b max. mm mm	Head thickness a max. mm	Depth of crank h max. mm	⚖ g
98 01 07	020134	⚡ 1000 V	7.0	150.0	12.0	7.0	18.0	55
98 01 08	020141		8.0	155.0	14.0	7.0	19.0	68
98 01 09	020158		9.0	165.0	15.5	8.0	19.0	78
98 01 10	020196		10.0	160.0	17.0	9.0	20.0	75
98 01 11	020202		11.0	165.0	18.5	10.0	21.0	93
98 01 12	020226		12.0	185.0	18.5	10.0	23.0	118
98 01 13	020233		13.0	185.0	21.5	11.0	23.0	125
98 01 14	020240		14.0	195.0	23.0	12.0	24.0	147
98 01 15	020257		15.0	200.0	24.0	12.0	24.0	143
98 01 16	020264		16.0	200.0	26.0	12.0	26.0	172
98 01 17	020271		17.0	205.0	27.0	13.0	26.0	184
98 01 18	020288		18.0	210.0	29.0	13.0	28.0	210
98 01 19	020295		19.0	225.0	30.0	14.0	28.0	245
98 01 22	020301		22.0	225.0	35.0	15.0	30.0	278
98 01 24	020318		24.0	265.0	38.0	16.0	30.0	415

Nut Drivers

with screwdriver handle

- > Ergonomically optimised dual component handle for fatigue reduced work and optimum transmission of force
- > Handle design prevents rolling
- > Chrome vanadium molybdenum steel
- > DIN EN 60900, IEC 60900



98 03 10

Article No.	EAN 4003773-	↔ mm		Tip	Handle	Width across flats S mm	Blade length mm	Handle length mm	Head dia. mm	△ g
98 03 04	071679	230		burnished	insulating multi-component handle, VDE-tested	4.0	125.0	107.0	9.0	70
98 03 05	071686	230				5.0	125.0	107.0	10.0	70
98 03 055	026082	232				5.5	125.0	107.0	11.0	87
98 03 06	026099	232				6.0	125.0	107.0	12.0	88
98 03 07	026105	237				7.0	125.0	112.0	14.0	123
98 03 08	024095	237				8.0	125.0	112.0	15.0	125
98 03 09	026112	237				9.0	125.0	112.0	16.0	129
98 03 10	026129	237				10.0	125.0	112.0	17.0	118
98 03 11	026136	237				11.0	125.0	112.0	19.0	148
98 03 12	026143	237				12.0	125.0	112.0	20.0	150
98 03 13	026150	237				13.0	125.0	112.0	21.0	152

Nut Drivers

with T-handle

- > Special tool steel, oil-hardened
- > DIN EN 60900, IEC 60900



98 04 13



98 05 13

Article No.	EAN 4003773-	↔ mm		Width across flats S mm	Handle length mm	Head dia. mm	△ g
98 04 08	071341	200		8.0	90.0	15.0	344
98 04 10	026167	200		10.0	155.0	19.5	324
98 04 13	026198	200		13.0	155.0	23.5	344
98 04 17	026211	200		17.0	155.0	28.5	426
98 04 19	020424	200		19.0	155.0	31.0	525
98 04 22	026228	200		22.0	155.0	34.5	560
98 05 13	026273	300			13.0	155.0	23.5
98 05 17	026297	300	17.0		155.0	28.5	544
98 05 19	026303	300	19.0		155.0	31.0	674

Screwdrivers for hexagon socket screws

- > Ergonomically optimised dual component handle for fatigue reduced work and optimum transmission of force
- > Handle design prevents rolling
- > Chrome vanadium molybdenum steel
- > DIN EN 60900, IEC 60900



98 13 30

Article No.	EAN 4003773-	↔ mm		Tip	Handle	Width across flats S mm	Blade length mm	Length of non-insulated blade mm	Handle length mm	⚖ g
98 13 20	071693	175		burnished	insulating multi-component handle, VDE-tested	2.0	75.0	15.0	102.0	40
98 13 25	026334	177				2.5	75.0	15.0	102.0	32
98 13 30	026341	182				3.0	75.0	15.0	107.0	49
98 13 40	026358	182				4.0	75.0	15.0	107.0	55
98 13 50	026365	187				5.0	75.0	15.0	112.0	82
98 13 60	026372	212				6.0	100.0	15.0	112.0	98

Screwdrivers for hexagon socket screws

with T-handle

- > Special tool steel, oil-hardened
- > DIN EN 60900, IEC 60900



98 14 08



98 15 08

Article No.	EAN 4003773-	↔ mm		Width across flats S mm	Length of non-insulated blade ± 2 mm	T-Handle length mm	⚖ g
98 14 05	020431	120		5.0	9.0	90.0	220
98 14 06	020448	120		6.0	10.0	90.0	208
98 14 08	020455	120		8.0	11.0	90.0	286
98 15 05	020479	250		5.0	9.0	90.0	363
98 15 06	020486	250		6.0	10.0	90.0	452
98 15 08	020493	250		8.0	11.0	90.0	359

Screwdriver for slotted screws

- > Ergonomically optimised dual component handle for fatigue reduced work and optimum transmission of force
- > Handle design prevents rolling
- > Chrome vanadium molybdenum steel
- > DIN EN 60900, IEC 60900



Article No.	EAN 4003773-	↔ mm		Tip	Handle	Blade width mm	Blade thickness mm	Blade length mm	Length of non-insulated blade mm	Handle length mm	△△ g
98 20 10	026396	320		burnished	insulating multi-component handle, VDE-tested	10.0	1.6	200.0	15.0	120.0	184
98 20 25	062325	177				2.5	0.4	75.0	15.0	102.0	32
98 20 30	062332	202				3.0	0.5	100.0	15.0	102.0	35
98 20 35	024217	202				3.5	0.6	100.0	15.0	102.0	35
98 20 40	026402	202				4.0	0.8	100.0	15.0	102.0	38
98 20 55	024224	232				5.5	1.0	125.0	15.0	107.0	69
98 20 65	026419	262				6.5	1.2	150.0	15.0	112.0	105
98 20 80	024231	295				8.0	1.2	175.0	15.0	120.0	152
98 21 45	026426	287				4.5	0.8	180.0	15.0	107.0	66

Screwdrivers (Slim) for slotted screws

- > Reduced blade isolation diameter for recessed spring and screw elements
- > Ergonomically optimised dual component handle for fatigue reduced work and optimum transmission of force
- > Handle design prevents rolling
- > Chrome vanadium molybdenum steel
- > DIN EN 60900, IEC 60900



Article No.	EAN 4003773-	↔ mm		Tip	Handle	Blade width mm	Blade thickness mm	Blade length mm	Length of non-insulated blade mm	Handle length mm	△△ g
98 20 35 SL	079712	202		burnished	insulating multi-component handle, VDE-tested	3.5	0.6	100.0	15.0	102.0	35
98 20 40 SL	079729	202				4.0	0.8	100.0	15.0	102.0	38
98 20 55 SL	079736	232				5.5	1.0	125.0	15.0	107.0	69
98 20 65 SL	079743	262				6.5	1.2	150.0	15.0	112.0	105

Screwdrivers for cross-recessed screws

Phillips®

- > Ergonomically optimised dual component handle for fatigue reduced work and optimum transmission of force
- > Handle design prevents rolling
- > Chrome vanadium molybdenum steel
- > DIN EN 60900, IEC 60900



Article No.	EAN 4003773-	↔ mm		Tip	Handle	Size	Blade length mm	Length of non-insulated blade mm	Handle length mm	△△ g
98 24 00	026433	162		burnished	insulating multi-component handle, VDE-tested	PH0	60.0	15.0	102.0	32
98 24 01	026440	187				PH1	80.0	15.0	107.0	58
98 24 02	026457	212				PH2	100.0	18.0	112.0	94
98 24 03	026464	270				PH3	150.0	18.0	120.0	165
98 24 04	026471	320				PH4	200.0	18.0	120.0	244

Screwdrivers (Slim) for cross-recessed screws

Phillips®

- > Reduced blade isolation diameter for recessed spring and screw elements
- > Ergonomically optimised dual component handle for fatigue reduced work and optimum transmission of force
- > Handle design prevents rolling
- > Chrome vanadium molybdenum steel
- > DIN EN 60900, IEC 60900



98 24 02 SL

Article No.	EAN 4003773-	↔ mm		Tip	Handle	Size	Blade length mm	Length of non-insulated blade mm	Handle length mm	⚖ g
98 24 01 SL	079750	187	⚡ 1000 V	burnished	insulating multi-component handle, VDE-tested	PH1	80.0	15.0	107.0	58
98 24 02 SL	079767	212	⚡ 1000 V			PH2	100.0	18.0	112.0	94

Screwdrivers (Slim) Plus/Minus

Phillips®

- > Driving tips for PlusMinus profile screws
- > Use with electronics installation components, e.g. automatic circuit breakers
- > Reduced blade isolation diameter for recessed spring and screw elements
- > Ergonomically optimised dual component handle for fatigue reduced work and optimum transmission of force
- > Handle design prevents rolling
- > Chrome vanadium molybdenum steel
- > DIN EN 60900, IEC 60900



98 24 01 SLS

Article No.	EAN 4003773-	↔ mm		Tip	Handle	Size	Blade length mm	Length of non-insulated blade mm	Handle length mm	⚖ g
98 24 01 SLS	081036	187	⚡ 1000 V	burnished	insulating multi-component handle, VDE-tested	PH/S 1	80.0	15.0	107.0	56
98 24 02 SLS	081043	212	⚡ 1000 V			PH/S 2	100.0	18.0	112.0	90

Screwdrivers for cross-recessed screws

Pozidriv®

- > Ergonomically optimised dual component handle for fatigue reduced work and optimum transmission of force
- > Handle design prevents rolling
- > Chrome vanadium molybdenum steel
- > DIN EN 60900, IEC 60900



98 25 03

Article No.	EAN 4003773-	↔ mm		Tip	Handle	Size	Blade length mm	Length of non-insulated blade mm	Handle length mm	⚖ g
98 25 00	062370	162	⚡ 1000 V	burnished	insulating multi-component handle, VDE-tested	PZ0	60.0	15.0	102.0	32
98 25 01	031260	187				PZ1	80.0	15.0	107.0	58
98 25 02	031277	212				PZ2	100.0	18.0	112.0	90
98 25 03	031284	270				PZ3	150.0	18.0	120.0	167
98 25 04	062387	320				PZ4	200.0	18.0	120.0	245

Screwdrivers (Slim) for cross-recessed screws

Pozidriv®

- > Reduced blade isolation diameter for recessed spring and screw elements
- > Ergonomically optimised dual component handle for fatigue reduced work and optimum transmission of force
- > Handle design prevents rolling
- > Chrome vanadium molybdenum steel
- > DIN EN 60900, IEC 60900



98 25 02 SL

Article No.	EAN 4003773-	↔ mm		Tip	Handle	Size	Blade length mm	Length of non-insulated blade mm	Handle length mm	⚖ g
98 25 01 SL	079774	187	⚠ 1000V	burnished	insulating multi-component handle, VDE-tested	PZ1	80.0	15.0	107.0	56
98 25 02 SL	079781	212	⚠ 1000V	burnished	insulating multi-component handle, VDE-tested	PZ2	100.0	18.0	112.0	90

Screwdrivers for Torx® screws

- > Ergonomically optimised dual component handle for fatigue reduced work and optimum transmission of force
- > Handle design prevents rolling
- > Chrome vanadium molybdenum steel
- > DIN EN 60900, IEC 60900



98 26 30

Article No.	EAN 4003773-	↔ mm		Tip	Handle	Size	Blade length mm	Length of non-insulated blade mm	Handle length mm	⚖ g
98 26 10	071709	160	⚠ 1000V	burnished	insulating multi-component handle, VDE-tested	TX10	60.0	15.0	102.0	32
98 26 15	071716	185				TX15	80.0	15.0	107.0	58
98 26 20	071723	185				TX20	80.0	15.0	107.0	58
98 26 25	071730	185				TX25	80.0	15.0	107.0	58
98 26 30	071747	210				TX30	100.0	18.0	112.0	94

Sockets with Torx drive

3/8"

> DIN EN 60900, IEC 60900

Article No.	EAN 4003773-	↔ mm		Size	⚖ g
98 29 25	084600	123	⚡ 1000 V	TX25	58
98 29 27	084617	123	⚡ 1000 V	TX27	58
98 29 30	084624	123	⚡ 1000 V	TX30	59
98 29 40	084631	123	⚡ 1000 V	TX40	59
98 29 45	084648	117	⚡ 1000 V	TX45	109
98 29 50	084655	117	⚡ 1000 V	TX50	111



98 29 25



98 29 30



98 29 50

T-handle

with driving square 3/8" or 1/2"

- > For use with sockets
- > Quick, easy and reliable locking of attached sockets thanks to spring-loaded ball
- > Basic tool chrome plated
- > High-grade special tool steel, forged, oil-hardened
- > DIN EN 60900, IEC 60900

Article No.	EAN 4003773-	↔ mm		T-Handle Drive mm	Square drive Inch	⚖ g
98 30	026488	200	⚡ 1000 V	165.0	3/8	447
98 40	026501	200	⚡ 1000 V	165.0	1/2	631



98 30



98 40

Reversible Ratchets

with driving square 3/8" or 1/2"

- > For use with sockets
- > Reversible for clockwise and anti-clockwise directions
- > Extremely smooth action
- > Quick, easy and reliable locking of attached sockets thanks to spring-loaded ball
- > Chrome vanadium steel, forged
- > DIN EN 60900, IEC 60900



98 31



98 41

Article No.	EAN 4003773-	↔ mm		Square drive Inch	⚖ g
98 31	026495	190	⚡ 1000 V	3/8	324
98 41	026518	265	⚡ 1000 V	1/2	625

Extension Bars

with internal and driving square 3/8" or 1/2"

- > For use with sockets
- > With internal and external square
- > Quick, easy and reliable locking of attached sockets thanks to spring-loaded ball
- > Chrome vanadium steel, forged
- > DIN EN 60900, IEC 60900



98 35 125



98 45 250

Article No.	EAN 4003773-	↔ mm		Square drive Inch	⚖ g
98 35 125	020530	125	⚡ 1000V	3/8	149
98 35 250	020547	250		3/8	294
98 45 125	020813	125	⚡ 1000V	1/2	258
98 45 250	020820	250		1/2	490

Hexagon Sockets for hexagonal socket screws

for internal square 3/8" or 1/2"

- > For metric and imperial hexagonal head screws
- > Basic tool chrome plated
- > Chrome Vanadium steel
- > DIN EN 60900, IEC 60900



98 37 17



98 47 17

Article No.	EAN 4003773-	↔ mm		Width across flats S mm	dia. of effective tool side d max. mm	Square drive Inch	⚖ g
98 37 10	020578	42	⚡ 1000V	10.0	18.7	3/8	32
98 37 11	020585	43		11.0	20.0	3/8	32
98 37 12	020608	44		12.0	21.2	3/8	33
98 37 13	020615	45		13.0	22.5	3/8	33
98 37 14	020622	46		14.0	23.7	3/8	39
98 37 16	027263	46		16.0	26.2	3/8	53
98 37 17	020639	46		17.0	27.5	3/8	61
98 37 19	020646	49		19.0	30.0	3/8	73
98 47 10	020882	54		⚡ 1000V	10.0	19.5	1/2
98 47 11	020899	54	11.0		20.7	1/2	61
98 47 12	020912	55	12.0		23.0	1/2	64
98 47 13	020929	55	13.0		23.2	1/2	64
98 47 14	020943	55	14.0		24.5	1/2	67
98 47 16	027287	55	16.0		26.9	1/2	69
98 47 17	020967	55	17.0		28.2	1/2	75
98 47 18	027294	55	18.0		29.0	1/2	81
98 47 19	020974	54	19.0		30.7	1/2	99
98 47 22	020981	58	22.0		34.5	1/2	125
98 47 24	020998	61	24.0		37.0	1/2	151
98 47 27	021001	63	27.0		41.0	1/2	183

12-Point Sockets

for internal square 3/8" or 1/2"

- > For imperial hexagonal head screws
- > Basic tool chrome plated
- > With double-hex
- > Chrome Vanadium steel
- > DIN EN 60900, IEC 60900



98 37 5



98 47 1



98 47 17

Article No.	EAN 4003773-	↔ mm		Width across flats S Inch	dia. of effective tool side d max. mm	Square drive Inch	△ g
98 37 5/16"	020684	42	△ 1000 V	5/16	16.2	3/8	30
98 37 3/8"	020677	42		3/8	18.7	3/8	31
98 37 7/16"	020707	43		7/16	20.0	3/8	31
98 37 1/2"	020554	45		1/2	22.5	3/8	33
98 37 9/16"	020721	47		9/16	23.7	3/8	39
98 37 5/8"	020691	46		5/8	26.2	3/8	51
98 37 3/4"	020660	49		3/4	30.0	3/8	71
98 47 1/2"	020875	55		△ 1000 V	1/2	23.2	1/2
98 47 9/16"	021094	55	9/16		24.5	1/2	64
98 47 5/8"	021063	55	5/8		26.9	1/2	72
98 47 11/16"	020905	55	11/16		28.2	1/2	88
98 47 3/4"	021018	55	3/4		30.7	1/2	97
98 47 7/8"	021087	58	7/8		34.5	1/2	124
98 47 1"	020868	61	1		41.0	1/2	167

Hexagon Sockets for hexagonal socket screws

for internal square 3/8" or 1/2"

- > For metric internal hexagonal head screws
- > Basic tool chrome plated
- > Special tool steel
- > DIN 7422, DIN EN 60900, IEC 60900



98 39 06

Article No.	EAN 4003773-	↔ mm		Width across flats S mm	Length of non-insulated blade ± 2 mm	Square drive Inch	△ g
98 39 05	020776	75	△ 1000 V	5.0	9.0	3/8	59
98 39 06	020783	75		6.0	10.0	3/8	58
98 39 08	020790	75		8.0	11.0	3/8	71
98 49 05	021155	75	△ 1000 V	5.0	9.0	1/2	68
98 49 06	021162	75		6.0	10.0	1/2	72
98 49 08	021179	75		8.0	11.0	1/2	87

Reversible Ratchet

with driving square 1/2"

- > Reversible for clockwise and anti-clockwise directions
- > Very reliable retention of the actuating tools ensured by mechanically locked retaining system
- > Chrome Vanadium steel
- > ISO 3315, DIN EN 60900, IEC 60900



98 42

Article No.	EAN 4003773-	↔ mm		Square drive Inch	⚖ g
98 42	026525	265	⚡ 1000 V	1/2	599

Torque Wrenches

with driving square, reversible

- > Reversible for tightening of lefthanded threads
- > Lockable torque adjustment
- > Easy and secure locking of attached sockets due to screw lock
- > Calibration certificate included
- > Transparent insulated scale range 5 - 50 Nm
- > Adjustable in steps of 0.25 Nm
- > Chrome Vanadium steel
- > ISO 3315, DIN EN 60900, IEC 60900



98 33 25



98 33 50



98 43 50

Article No.	EAN 4003773-	↔ mm		Square drive Inch	⚖ g
98 33 25	072676	290	⚡ 1000 V ⚡	3/8	1230
98 33 50	071761	385		3/8	1230
98 43 50	071778	385	⚡ 1000 V ⚡	1/2	1230

Cable Knives

- > Ergonomically designed handle shape with comfortable slip guard
- > Particularly confident grip thanks to slip-proof soft components
- > Thumb recess and "finger hook" at the end of the handle ensure a good transmission of force when the blade is pulled
- > Solid, fixed straight blade
- > Transparent protective cap
- > Blade: special tool steel, oil-hardened
- > DIN EN 60900, IEC 60900

98 54

- > Back of the blade plastic coated to avoid short circuits



98 52



98 54

Article No.	EAN 4003773-	↔ mm		Handle	Blade length mm	△ g
98 52	035565	190	⚡ 1000V	insulating multi-component handle, VDE-tested	50.0	67
98 54	026563	190	⚡ 1000V	insulating multi-component handle, VDE-tested	50.0	68

Stripping Knives

with guide shoe

- > Ergonomically designed handle shape with comfortable slip guard
- > Particularly confident grip thanks to slip-proof soft components
- > Thumb recess and "finger hook" at the end of the handle ensure a good transmission of force when the blade is pulled
- > Transparent protective cap
- > DIN EN 60900, IEC 60900

98 53 03

- > Solid, fixed hook blade; suitable for round cables; blade: special tool steel, oil-hardened

98 53 13

- > Narrow, fixed hook blade, sickle shaped; suitable for sector cables; blade: special tool steel, oil-hardened

98 55

- > Solid, fixed hook blade, sickle shaped; with guide shoe at the blade point; no damage of the conductor insulation; blade: surgical steel, stainless, vacuum-hardened



98 53 03



98 53 13



98 55



Guide shoe 98 55

Article No.	EAN 4003773-	↔ mm		Handle	Blade length mm	Radius mm	△ g
98 53 03	026549	170	⚡ 1000V	insulating multi-component handle, VDE-tested	28.0	7.0	64
98 53 13	026556	190	⚡ 1000V	insulating multi-component handle, VDE-tested	50.0	40.0	64
98 55	022558	180	⚡ 1000V	insulating multi-component handle, VDE-tested	38.0	23.5	68

Cable Knives

with replaceable blade

- > Straight blade with special sharpening; replaceable
- > With hinged blade guard, integrated in the handle, captive
- > Back of the blade plastic coated to avoid short circuits
- > Ergonomically shaped insulating handle
- > Blade: surgical steel, stainless, vacuum-hardened
- > DIN EN 60900, IEC 60900



98 56

Article No.	EAN 4003773-	↔ mm		Blade length mm	⚖ g
98 56	026570	190	⚡ 1000V ⚠	50.0	64
98 56 09	030829	Spare blade for 98 56			

Plastic Flat Nose Pliers

insulating

- > Fully insulating to reduce risk of short circuit
- > For meter assembly and meter blocking
- > Class C; range of use up to -40°C
- > Plastic material, fibreglass-reinforced
- > Handles with soft plastic zone for better grip
- > DIN EN 60900, IEC 60900



98 62 01

Article No.	EAN 4003773-	↔ mm		⚖ g
98 62 01	073956	180	⚡ 1000V ⚠	120



Plastic Snipe Nose Pliers

insulating

- > Fully insulating to reduce risk of short circuit
- > Class C; range of use up to -40°C
- > Plastic material, fibreglass-reinforced
- > Handles with soft plastic zone for better grip
- > DIN EN 60900, IEC 60900



98 62 02

Article No.	EAN 4003773-	↔ mm		⚖ g
98 62 02	073963	220	⚡ 1000V ⚠	130



KNIPLEX presents high-quality and sturdy plastic pliers featuring protection against bridging for working on live parts up to AC 1000V and DC 1500V. These solid plastic pliers do not act on magnetic fields either and they are fully spark-free. They are also excellent for use in chemically aggressive environments.

Insulating clamps

plastic

- > For holding insulating mats in place
- > With integrated spring
- > Fully insulated to avoid short circuits
- > Solid plastic, fibreglass-reinforced
- > DIN VDE 0680-1



98 64 02

Article No.	EAN 4003773-	↔ mm		Clamping capacity	⚖ g
98 64 02	021193	150	⚡ 1000 V / III	15.0	61

Plastic Slip-On Caps

conical

- > To cover bare live cable ends (max. 10 mm dia.)
- > Plastic



98 65 03

Article No.	EAN 4003773-	↔ mm		Conductor key	⚖ g
98 65 01	021209	80	⚡ 1000 V	1	7
98 65 02	021216	80		2	8
98 65 03	021223	80		3	8

Self-Clamping Slip-On Caps

- > To cover bare live cable ends
- > Plastic



98 66 20



98 66 50

Article No.	EAN 4003773-	↔ mm		Inside dia. mm	⚖ g
98 66 10	084181	80	⚡ 1000 V	10.0	10
98 66 20	084198	100		20.0	35
98 66 30	084204	110		30.0	50
98 66 40	083498	135		40.0	75
98 66 45	083382	130		45.0	90
98 66 50	083504	135		50.0	95
98 66 60	084419	140		60.0	120

Electricians' Gloves

- > For added protection when working live or close to live parts
- > DIN EN 60903, IEC 60903



98 65 40

Article No.	EAN 4003773-		Size	⚖ g
98 65 40	021285	⚡ 1000 V	9	281
98 65 41	021292		10	290
98 65 42	077862		11	290

Insulating Mats

from rubber

- > For added protection when working live or close to live parts
- > DIN/EN IEC 61112



98 67 05

Article No.	EAN 4003773-		Dimensions mm	Thickness mm	⚖ g
98 67 05	026600	⚠ 1000 V ⚡ ⚙	500 x 500 x 1 mm	1.0	301
98 67 10	026617		1000 x 1000 x 1 mm	1.0	820
98 67 15	077831		10000 x 1000 x 1 mm	1.0	12000

Stand Mats

from rubber

- > For site insulation when working live or close to live parts
- > IEC 61111

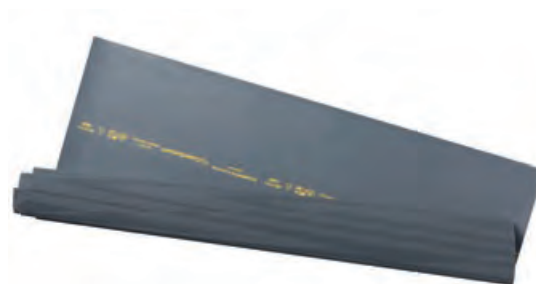

98 67 20

Article No.	EAN 4003773-		Dimensions mm	Thickness mm	⚖ g
98 67 20	077848	⚠ 1000 V ⚡ ⚙	1000 x 1000 x 3 mm	3.0	3150
98 67 25	077855		10000 x 1000 x 3 mm	3.0	40000

PUK® Junior Hacksaw

- > Saw blade for metal and wood with 25 teeth per inch, exchangeable
- > DIN EN 60900, IEC 60900



98 90

Article No.	EAN 4003773-	↔ mm		Saw blade length	⚖ g
98 90	028321	240	⚠ 1000 V	150.0	174
98 90 01	084358	Saw blades for PUK® saw 98 90			

Compact Tool Case

17 parts

► With insulated tools for works on electrical installations

- > Shock-resistant plastic case
- > Foam insert with precise recesses for holding the pliers
- > Equipped with a range of customary insulated KNIPEX tools for work on electrical systems
- > All tools are tested one by one and meet the requirements of IEC 60900
- > Dimensions, exterior (W x H x D): 380 x 85 x 260 mm
- > DIN EN 60900, IEC 60900



98 99 11

Article No.	EAN 4003773- 026624				Quantity	g ⚖
98 99 11			Compact Tool Case 17 parts			3675
		⚠ 1000 V	03 07 200	Combination Pliers	1	
		⚠ 1000 V	70 07 160	Diagonal Cutter	1	
			98 20 35		1	
		⚠ 1000 V	98 20 40	Screwdrivers for slotted screws	1	
			98 20 55		1	
		⚠ 1000 V	98 24 00	Screwdriver for cross recessed screws, Phillips®	1	
		⚠ 1000 V	98 42	Reversible Ratchet, with driving square 1/2"	1	
		⚠ 1000 V	98 45 125	Extension Bar, with internal/external square 1/2"	1	
			98 45 250		1	
			98 47 10		1	
			98 47 11		1	
			98 47 12		1	
		⚠ 1000 V	98 47 13	Hexagon Socket for hexagonal screws, with internal square 1/2"	1	
			98 47 14		1	
			98 47 17		1	
			98 47 19		1	
		⚠ 1000 V	98 52	Cable Knife	1	

Compact Tool Case

























26 parts

► With insulated tools for works on electrical installations

- > Shock-resistant plastic case
- > Foam insert with precise recesses for holding the pliers
- > Equipped with a range of customary insulated KNIPEX tools for work on electrical systems
- > Fixable partition wall
- > Dimensions, exterior (W x H x D): 440 x 105 x 385 mm



98 99 12

Article No.	EAN 4003773-				Quantity	g
98 99 12	026631			Standard Tool Case 26 parts		5533
		   	03 07 200	Combination Pliers	1	
		  	70 07 160	Diagonal Cutter	1	
			98 00 10	Open End Wrench	1	
			98 00 11		1	
			98 00 12		1	
		 	98 00 13		1	
			98 00 14		1	
			98 00 17		1	
			98 00 19		1	
		 	98 53 03	Dismantling Knife for round cables	1	
			98 20 25	Screwdrivers for slotted screws	1	
		  	98 20 35		1	
			98 20 40		1	
			98 20 55		1	
			98 24 00	Screwdriver for cross recessed screws,Phillips®	1	
		  	98 24 01		1	
			98 24 02	1		
		 	98 40	T-Handle Drive, with driving square 1/2"	1	
			98 47 10	Hexagon Socket for hexagonal screws, with internal square 1/2"	1	
			98 47 11		1	
			98 47 12		1	
		  	98 47 13		1	
			98 47 14		1	
			98 47 17		1	
			98 47 19	1		
		 	98 52	Cable Knife	1	

Tool Box "RED" Electro Set 1

Versatile use: the small four-piece VDE tool range in a handy case

- > High quality, versatile, shock-resistant plastic case
- > Foam insert with honeycomb structure for variable equipment
- > Dimensions, exterior (W x H x D): 340 x 56 x 275 mm

00 20 15

- > Pliers VDE-tested according to DIN EN/IEC 60900 1000V

00 21 15 LE

- > Box without tools



Article No.	EAN				Number	g
00 20 15	4003773-024804			Tool Box "RED" Electro-Set 1, 4 parts		1430
			03 06 180	Combination Pliers	1	
			11 06 160	Insulation Stripper	1	
			26 16 200	Snipe Nose Side Cutting Pliers (Stork Beak Pliers)	1	
			70 06 160	Diagonal Cutter	1	
00 21 15 LE	045175			Tool Box "RED", empty		530

Tool Box "RED" Electro Set 2

All you need, safely stored: seven-piece VDE tool set for electrical installation

- > High quality, versatile, shock-resistant plastic case
- > Foam insert with honeycomb structure for variable equipment
- > Dimensions, exterior (W x H x D): 340 x 56 x 275 mm

00 21 15

- > All pliers and screwdrivers except Water Pump Pliers VDE-tested according to DIN EN/IEC 60900

00 21 15 LE

- > Box without tools



Article No.	EAN				Number	Nominal size	g
00 21 15	4003773-042853			Tool Box "RED" Electro-Set 2, 7 parts			1520
			03 06 180	Combination Pliers	1	180 mm	
			26 16 200	Snipe Nose Side Cutting Pliers (Stork Beak Pliers)	1	200 mm	
			70 06 160	Diagonal Cutter	1	160 mm	
			88 03 180	KNIPEX Alligator®, Water Pump Pliers	1	180 mm	
				Screwdrivers for slotted screws, 160i	1	0.4 x 2.5 x 80 mm	
				Screwdrivers for cross recessed Phillips® screws, 162i PH	1	0.8 x 4.0 x 100 mm	
				Screwdrivers for cross recessed Phillips® screws, 162i PH	1	PH1 x 80 mm	
00 21 15 LE	045175			Tool Box "RED", empty			530















Tool Roll

Essential for work on electrical systems: 15-piece basic tool kit in practical roll-up bag

- > Tool roll made of hard-wearing polyester fabric
- > With practical, adjustable quick release fastener
- > Equipped with a range of insulated KNIPEX tools for works on electrical installations
- > Dimensions, open (L x H): 830 x 310 mm



98 99 13

Article No.	EAN				Number	g
98 99 13	4003773-026648			Tool Roll, 15 parts		2455
		 1000V 	03 07 200	Combination Pliers	1	
		 1000V 	11 07 160	Insulation Stripper	1	
		 	26 17 200	Snipe Nose Side Cutting Pliers (Stork Beak Pliers)	1	
			70 07 160	Diagonal Cutter	1	
			95 17 200	Cable Shears with twin cutting edge	1	
			98 00 10		1	
			98 00 13		1	
		 1000V 	98 00 14	Open-end wrench	1	
			98 00 17		1	
			98 00 19		1	
			98 20 25		1	
		 1000V 	98 20 40	Screwdrivers for slotted screws	1	
			98 20 55		1	
			98 20 65		1	
		 1000V 	98 52	Cable Knife	1	
98 99 13 LE	028888	Tool Roll, empty				325

Electronics pliers and Precision Tweezers



Electronic Super Knips® / ESD	240
Electronic Super Knips® XL / ESD	242
Precision Electronics Diagonal Cutters / ESD	244
Electronics Diagonal Cutters / ESD	246
Electronics Diagonal Cutters with carbide metal cutting edges	249
Electronics End Cutting Nippers / ESD	250
Electronics Oblique Cutting Nipper	251
Precision Electronics Gripping Pliers / ESD	252
– with precision laser cut cross-shaping	252
Electronics Pliers / ESD	253
Electronics Mounting Pliers	255
Electronics Pliers Sets	256
Precision Tweezers	257

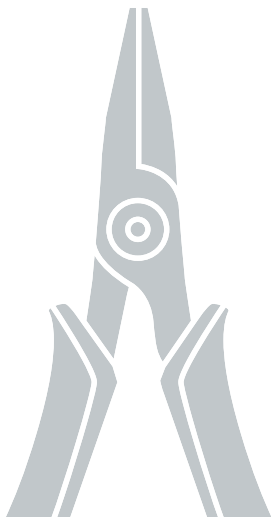

Electronic Super Knips®

- > Precision pliers for ultra fine cutting work, e. g. in electronics and fine mechanics
- > Ground, very sharp cutting edges without bevel
- > Precision shaped tips cut wires flush to a surface from $\varnothing 0.2$ mm.
- > Shear cut with controlled micro cutting edge misalignment for the most precise cutting of even the thinnest of wires and for a long service life
- > Joint with stainless steel rivet
- > Extremely smooth movement for minimum operator fatigue
- > With opening spring and opening limiter
- > Electrically discharging handles - dissipative
- > DIN ISO 9654

78 03 125/ESD / 78 23 125

- > INOX tool steel; cutting edge hardness approx. 54 HRC

78 13 125/ESD

- > INOX tool steel; cutting edge hardness approx. 54 HRC; with lead catcher – no uncontrolled loss of cut wire ends

78 31 125

- > Cutting edges additionally induction-hardened, cutting edge hardness approx. 60 HRC; with narrow head; special tool steel, burnished

78 41 125

- > With lead catcher - no uncontrolled loss of cut wire ends; with narrow head; cutting edges additionally induction-hardened, cutting edge hardness approx. 60 HRC; special tool steel, burnished

78 61 125/ESD

- > Also suitable for cutting glass fibre cables (fibre optics); cutting edges additionally induction-hardened, cutting edge hardness approx. 64 HRC; Special tool steel, oil hardened in multiple stages

78 71 125/ESD

- > With lead catcher – no uncontrolled loss of cut wire ends; cutting edges additionally induction-hardened, cutting edge hardness approx. 64 HRC; special tool steel, burnished



78 03 125



78 03 125 ESD



78 06 125



78 13 125



78 23 125



78 31 125



78 41 125

Models also for hard wire

78 81 125

- > Precision-ground cutting edges with very small bevel suitable also for hard wire; cutting edges additionally induction-hardened, cutting edge hardness approx. 64 HRC; special tool steel, burnished

78 91 125

- > Precision-ground cutting edges with very small bevel suitable also for hard wire; with lead catcher – no uncontrolled loss of cut wire ends; cutting edges additionally induction-hardened, cutting edge hardness approx. 64 HRC; special tool steel, burnished

ESD pliers (electrostatic discharge)

Electrostatic energy is discharged through the handles in a gradual and controlled manner. Which protects components endangered by electrostatic discharge. In accordance with applicable standards, e.g. IEC TR 61 340-5, DIN EN 61 340-5, SP Method 2472



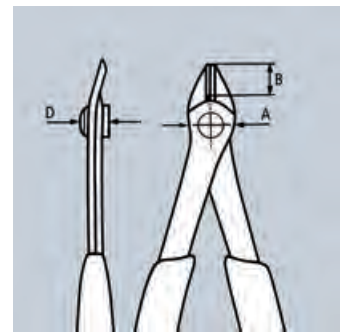
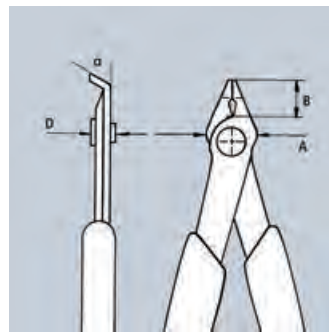
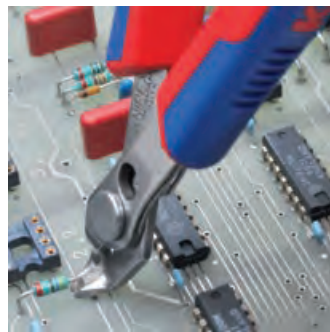
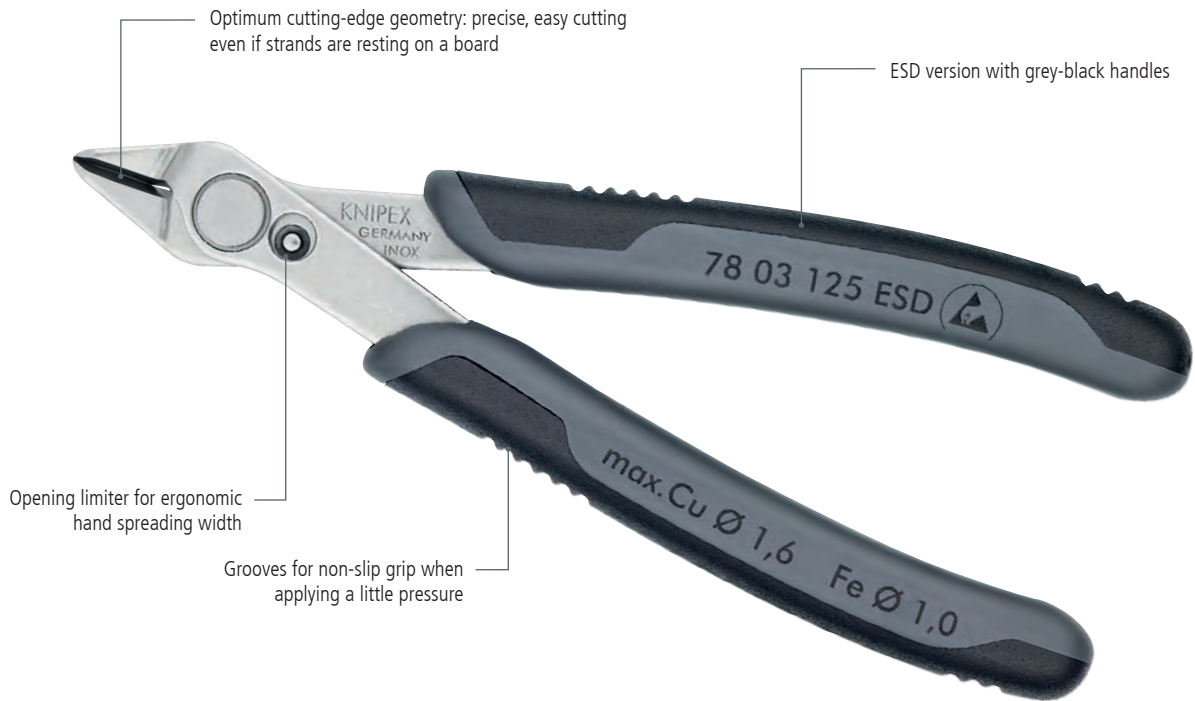

Article No.	EAN 4003773-	↔ mm	Pliers	Head	Handles	Cutting capacities			Dimensions				
						Ø mm	Ø mm	Ø mm	B mm	A mm	D mm	g	
78 03 125	035381	125		polished	with multi-component grips	1.6	1.0		9.0	13.5	7.5	56	
78 03 125 ESD	025146	125		polished	with multi-component grips	1.6	1.0		9.0	13.5	7.5	55	
78 06 125	084099	125		polished	insulated with multi-component grips, VDE-tested	1.6	1.0		9.0	13.5	7.5	60	
78 13 125	035398	125		polished	with multi-component grips	1.6	1.0		9.0	13.5	7.5	57	
78 13 125 ESD	025153	125		polished	with multi-component grips	1.6	1.0		9.0	13.5	7.5	57	
78 23 125	043096	125		polished	with multi-component grips	1.0	0.6		5.5	13.5	7.5	55	
78 31 125	039778	125		burnished	burnished	with multi-component grips	1.0		9.0	12.5	7.5	55	
78 41 125	040767	125		burnished	burnished	with multi-component grips	1.0		9.0	12.5	7.5	57	
78 61 125	035404	125		burnished	burnished	with multi-component grips	1.6	1.2	9.0	13.5	7.5	56	
78 61 125 ESD	025184	125		burnished	burnished	with multi-component grips	1.6	1.2	9.0	13.5	7.5	56	
78 71 125	043799	125		burnished	burnished	with multi-component grips	1.6	1.2	9.0	13.5	7.5	57	
78 71 125 ESD	025191	125		burnished	burnished	with multi-component grips	1.6	1.2	9.0	13.5	7.5	57	
78 81 125	065074	125		burnished	burnished	with multi-component grips	1.6	1.2	0.6	9.0	13.5	7.5	57
78 91 125	065081	125		burnished	burnished	with multi-component grips	1.6	1.2	0.6	9.0	13.5	7.5	57

Electronic Super Knips® XL

- > For ultra fine cutting work, e.g. in electronics and fine mechanics
- > In particular for cutting cable ties to length
- > Ground, very sharp cutting edges without bevel
- > Shear cut with controlled micro cutting edge misalignment for the most precise cutting of even the thinnest of wires and for a long service life
- > Precision shaped tips cut wires flush to a surface from $\varnothing 0.2$ mm
- > Joint with stainless steel rivet
- > Extremely smooth movement for minimum operator fatigue
- > With opening spring and opening limiter
- > DIN ISO 9654



78 03 140



78 61 140









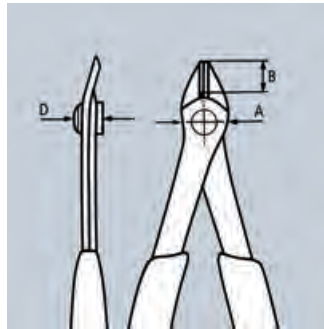

For flush cutting, e.g. for shortening cable ties



Shear cut with controlled micro cutting edge misalignment for the most precise cutting of even the thinnest of wires and for a long service life



Article No.	EAN 4003773-	↔ mm	 	Pliers	Head	Handles	Cutting capacities		Dimensions			
							 \varnothing mm	 \varnothing mm	B mm	A mm	D mm	Δ g
78 03 140	081647	140	 		polished	with multi-component grips	0.2 - 2.1	1.2	12.3	15.7	9.2	85
78 61 140	081685	140	 	burnished	burnished	with multi-component grips	0.2 - 2.1	1.4	12.3	15.7	9.2	85

Electronic Super Knips® XL ESD

- > For ultra fine cutting work, e.g. in electronics and fine mechanics
- > Ground, very sharp cutting edges without bevel
- > Precision shaped tips cut wires flush to a surface from $\varnothing 0.2$ mm.
- > Shear cut with controlled micro cutting edge misalignment for the most precise cutting of even the thinnest of wires and for a long service life
- > Joint with stainless steel rivet
- > Extremely smooth movement for minimum operator fatigue
- > With opening spring and opening limiter
- > DIN ISO 9654, DIN EN 61 340-5

78 61 140 ESD

- > Cutting edge hardness approx. 64 HRC; cutting edges additionally induction-hardened; Special tool steel, oil hardened in multiple stages

78 03 140 ESD

- > Cutting edge hardness approx. 54 HRC; INOX tool steel



78 03 140 ESD





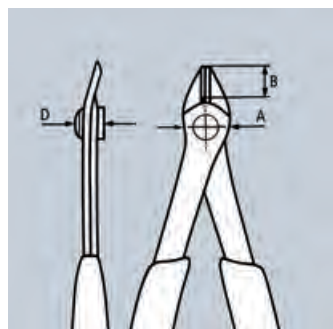



78 61 140 ESD



ESD pliers (electrostatic discharge)

Electrostatic energy is discharged through the handles in a gradual and controlled manner. Which protects components endangered by electrostatic discharge. In accordance with applicable standards, e.g. IEC TR 61 340-5, DIN EN 61 340-5, SP Method 2472



Article No.	EAN 4003773-	↔ mm		Pliers	Head	Handles	Cutting capacities		Dimensions			Δ g
							\varnothing mm	\varnothing mm	B mm	A mm	D mm	
78 03 140 ESD	081661	140	  		polished	with multi-component grips	0.2 - 2.1	1.2	12.3	15.7	9.2	77
78 61 140 ESD	081708	140	  	burnished	burnished	with multi-component grips	0.2 - 2.1	1.4	12.3	15.7	9.2	85

Precision Electronics Diagonal Cutters

- > Precision pliers for ultra fine cutting work, e. g. in electronics and fine mechanics
- > Very precisely ground and sharp cutting edges with very small bevels for exact cutting on delicate electronic components; also available without bevel for flush cutting
- > Cutting edges additionally induction-hardened, cutting edge hardness approx. 64 HRC
- > Approx. 20 % lighter than conventional electronics pliers
- > Bolted joint with carefully manufactured joint surfaces for even, low-friction movement throughout the entire opening range
- > Smooth-running double spring for a gentle and even opening
- > Ergonomically optimised multi-component handles
- > Ball bearing chrome steel, forged, multi stage oil-hardened
- > DIN ISO 9654

79 02 120 / 79 22 120

- > Mini-head

79 12 125

- > Specially for cutting through hard wire and piano wire

79 32 125 / 79 42 125

- > Pointed head

79 42 125 Z

- > For an optimised flush cutting result of soft materials

79 52 125 / 79 62 125

- > Pointed head; with lead catcher – no uncontrolled loss of cut wire ends

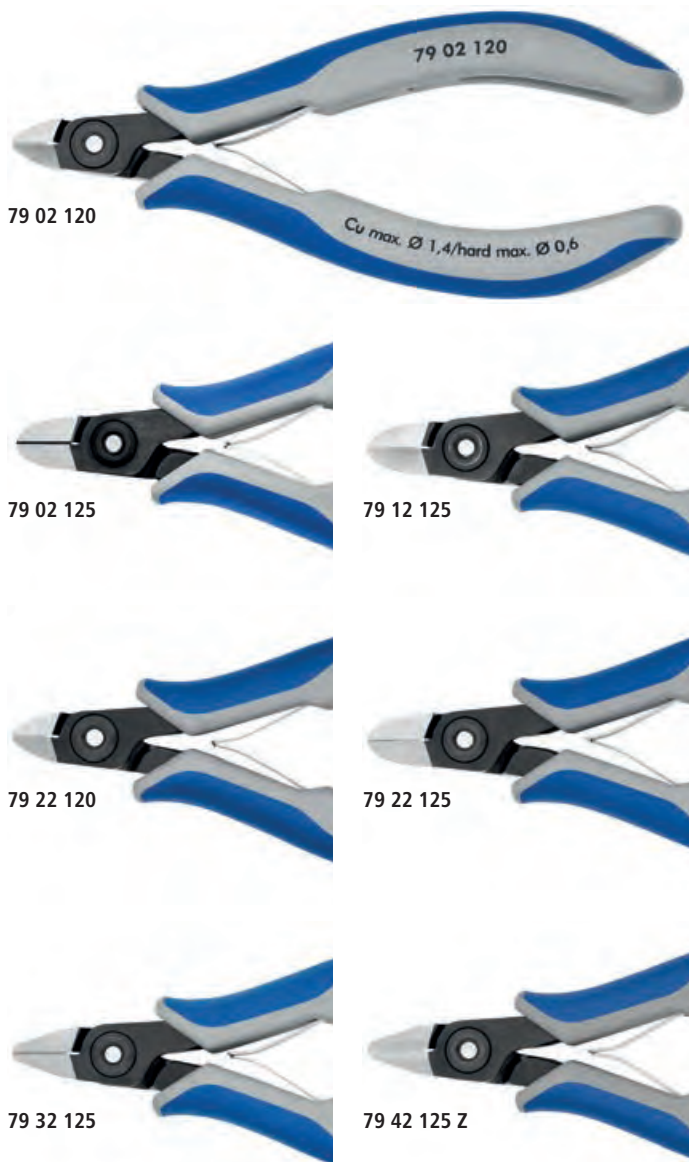

Material catcher for 79 02 / 22 125 ESD see page 142

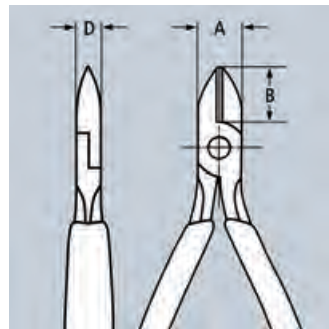

The subtle difference

KNIPEX precision electronics pliers are made of high-quality ball bearing steel and processed with the highest degree of care. Each opening movement is gentle and even without backlash. Each work step proceeds reliably and precisely. This makes work much easier for professionals.

Article No.	EAN 4003773-	↔ mm	Icon	Pliers	Head	Handles	Cutting capacities				Dimensions			g
							Ø mm	Ø mm	Ø mm	Ø mm	B mm	A mm	D mm	
79 02 120	061403	120	Icon	burnished	polished	with multi-component grips	0.2 - 1.4	1.0	0.6		6.5	9.0	6.5	57
79 02 125	061281	125	Icon	burnished	polished	with multi-component grips	0.2 - 1.7	1.3	0.7		10.0	11.0	6.5	59
79 02 125 S1	071808	125	Icon	burnished	polished	with multi-component grips	0.2 - 1.7	1.3	0.7		10.0	11.0	6.5	59
79 12 125	071365	125	Icon	burnished	polished	with multi-component grips	0.3 - 1.7	1.3	1.0	0.6	10.0	11.0	6.5	59
79 22 120	061427	120	Icon	burnished	polished	with multi-component grips	0.1 - 1.3	0.8			6.5	9.0	6.5	56
79 22 125	061342	125	Icon	burnished	polished	with multi-component grips	0.1 - 1.7	1.0			10.0	11.0	6.5	60
79 32 125	061366	125	Icon	burnished	polished	with multi-component grips	0.2 - 1.5	1.1	0.6		11.0	11.0	6.5	58
79 42 125	061380	125	Icon	burnished	polished	with multi-component grips	0.1 - 1.5	0.8			11.0	11.0	6.5	58
79 42 125 Z	078449	125	Icon	burnished	polished	with multi-component grips	0.1 - 1.3				11.0	11.0	6.5	58
79 52 125	065135	125	Icon	burnished	polished	with multi-component grips	0.2 - 1.3	0.9	0.5		11.0	11.0	6.5	58
79 62 125	065142	125	Icon	burnished	polished	with multi-component grips	0.1 - 1.3	0.8			11.0	11.0	6.5	58

Precision Electronics Diagonal Cutters ESD

► Electrically discharging handles – dissipative

- > Precision pliers for ultra fine cutting work, e. g. in electronics and fine mechanics
- > Very precisely ground and sharp cutting edges with very small bevels for exact cutting on delicate electronic components; also available without bevel for flush cutting
- > Precision cutting edges additionally induction-hardened, cutting edge hardness approx. 64 HRC
- > Approx. 20 % lighter than conventional electronics pliers
- > Bolted joint with carefully manufactured joint surfaces for even, low-friction movement throughout the entire opening range
- > Smooth-running double spring for a gentle and even opening
- > Ergonomically optimised multi-component handles
- > Ball bearing chrome steel, forged, multi stage oil-hardened
- > DIN ISO 9654, DIN EN 61 340-5

79 02 120 ESD / 79 22 120 ESD

- > Mini-head

79 02 125 ESD / 79 22 125 ESD

- > Round head

79 12 125 ESD

- > Specially for cutting through hard wire and piano wire

79 32 125 ESD / 79 42 125 ESD

- > Pointed head



79 02 120 ESD



79 02 125 ESD



79 12 125 ESD



79 22 120 ESD



79 22 125 ESD



79 32 125 ESD



79 42 125 Z ESD

ESD pliers (electrostatic discharge)

Electrostatic energy is discharged through the handles in a gradual and controlled manner. Which protects components endangered by electrostatic discharge. In accordance with applicable standards, e.g. IEC TR 61 340-5, DIN EN 61 340-5, SP Method 2472

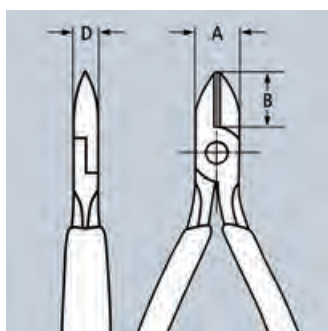

Article No.	EAN 4003773-	↔ mm		Pliers	Head	Handles	Cutting capacities				Dimensions			g			
							Ø mm	Ø mm	Ø mm	Ø mm	B mm	A mm	D mm				
79 02 120 ESD	061595	120				burnished	polished	with multi-component grips	0.2 - 1.4	1.0	0.6		6.5	9.0	6.5	60	
79 02 125 ESD	061519	125				burnished	polished	with multi-component grips	0.2 - 1.7	1.3	0.7		10.0	11.0	6.5	61	
79 12 125 ESD	071389	125				burnished	polished	with multi-component grips	0.3 - 1.7	1.3	1.0	0.6	10.0	11.0	6.5	61	
79 22 120 ESD	061618	120				burnished	polished	with multi-component grips	0.1 - 1.3	0.8			6.5	9.0	6.5	61	
79 22 125 ESD	061533	125				burnished	polished	with multi-component grips	0.1 - 1.7	1.0			10.0	11.0	6.5	61	
79 32 125 ESD	061557	125				burnished	polished	with multi-component grips	0.2 - 1.5	1.1	0.6		11.0	11.0	6.5	61	
79 42 125 ESD	061571	125				burnished	polished	with multi-component grips	0.1 - 1.5	0.8			11.0	11.0	6.5	58	
79 42 125 Z ESD	078456	125				burnished	polished	with multi-component grips	0.1 - 1.3				11.0	11.0	6.5	58	
79 52 125 ESD	065159	125					burnished	polished	with multi-component grips	0.2 - 1.3	0.9	0.5		11.0	11.0	6.5	58
79 62 125 ESD	065166	125					burnished	polished	with multi-component grips	0.1 - 1.3	0.8			11.0	11.0	6.5	58

Electronics Diagonal Cutters

- > Bolted joint for high precision and stress tolerance
- > For ultra fine cutting work, e.g. in electronics and fine mechanics
- > With sharp, ground cutting edges for soft and hard wire and piano wire
- > Cutting edges additionally induction-hardened, cutting edge hardness approx. 64 HRC
- > Low-friction double spring for gentle and even opening
- > High-grade special tool steel, forged, multi stage oil-hardened
- > DIN ISO 9654

Style 0

- > With bevel (outside bevel)

Style 2

- > With small bevel

Style 5

- > Particularly narrow head, with bevel



75 02 125



75 12 125



75 22 125



75 52 125

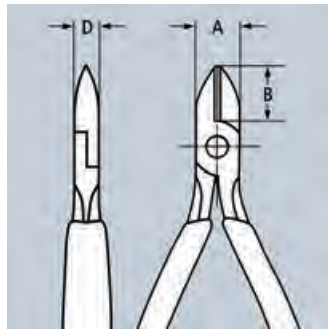
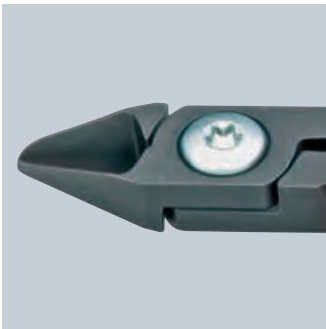

Bolted joint

Article No.	EAN 4003773	↔ mm		Style	Pliers	Handles	Cutting capacities				Dimensions			Δ g
							Ø mm	Ø mm	Ø mm	Ø mm	A mm	B mm	D mm	
75 02 125	043720	125		0	burnished	with plastic grips	0.2 - 1.3	1.0	0.6	0.4	10.5	14.0	6.5	80
75 12 125	040514	125		1	burnished	with plastic grips	0.2 - 1.3	1.0	0.6	0.4	10.5	14.0	6.5	80
75 22 125	040538	125		2	burnished	with plastic grips	0.2 - 1.3	0.9	0.4	0.3	10.5	14.0	6.5	79
75 52 125	043737	125		5	burnished	with plastic grips	0.2 - 0.8	0.5	0.3		10.5	14.0	6.5	75

Electronics Diagonal Cutters

with box joint

- > For fine cutting work, e.g. in electronics and fine mechanics
- > Load-optimised for a more direct feel when working
- > Low-friction double spring for gentle and even opening
- > The mirror polish together with a fine film of oil offer effective rust protection – no circuit faults caused by peeling chrome from plated tools
- > Cutters additionally laser hardened, cutter hardness at least 60 HRC
- > Narrow sleeves pulled up to the head of the pliers enable the tool to be guided securely and comfortably, also between thumb and index finger
- > Sturdy, zero-backlash box joint
- > Ball bearing chrome steel, oil-hardened
- > DIN ISO 9654

77 01 115 / 77 02 130

- > Round head, with bevel; cutting edge hardness approx. 60 HRC

77 02 115 / 77 22 130

- > Round head, with small bevel; cutting edge hardness approx. 60 HRC

77 11 115 / 77 12 115

- > Round head, with bevel and lead catcher – no uncontrolled loss of cut wire ends; cutting edge hardness approx. 60 HRC

77 21 115

- > Round head, without bevel; cutting edge hardness approx. 60 HRC

77 22 115

- > Round head, without bevel; cutting edge hardness approx. 60 HRC

77 32 115

- > Pointed head, with small bevel; cutting edge hardness approx. 60 HRC

77 42 115 / 77 42 130

- > Pointed head, without bevel; cutting edge hardness approx. 60 HRC

77 52 115

- > Pointed, flat head, with small bevel; cutting edge hardness approx. 60 HRC

77 72 115

- > Pointed mini-head, with small bevel; cutting edge hardness approx. 60 HRC



77 01 115



77 02 115



77 02 130



77 12 115



77 22 115

Article No.	EAN 4003773-	↔ mm		Head	Handles	Cutting capacities			Dimensions			
						⊙ mm	◐ mm	◑ mm	B mm	A mm	D mm	Δ g
77 01 115	018568	115	↘	mirror polished	plastic coated	0.3 - 1.6	1.2	0.6	14.0	11.0	7.5	50
77 01 130	018575	130	↘	mirror polished	plastic coated	0.3 - 2.0	1.5	0.8	18.0	15.0	9.5	108
77 02 115	039334	115	↘	mirror polished	with multi-component grips	0.3 - 1.6	1.2	0.6	14.0	11.0	7.5	70
77 02 130	039341	130	↘	mirror polished	with multi-component grips	0.3 - 2.0	1.5	0.8	18.0	15.0	9.5	124
77 11 115	018629	115	↘	mirror polished	with non-slip plastic coating	0.3 - 1.6	1.2	0.6	14.0	11.0	7.5	55
77 12 115	043768	115	↘	mirror polished	with multi-component grips	0.3 - 1.6	1.2	0.6	14.0	11.0	7.5	70
77 21 115 N	082309	115	↘	mirror polished	plastic coated	1.3	1.0			11.0		50
77 21 130	018667	130	↘	mirror polished	plastic coated	0.3 - 1.6	1.3		18.0	14.0	9.5	110
77 22 115	043782	115	↘	mirror polished	with multi-component grips	0.3 - 1.3	1.0		14.0	11.0	7.0	70
77 22 130	040446	130	↘	mirror polished	with multi-component grips	0.3 - 2.0	1.5		18.0	15.0	9.0	124
77 32 115	044307	115	↘	mirror polished	with multi-component grips	0.3 - 1.3	1.0	0.5	14.0	11.0	7.5	65
77 41 115	082316	115	↘	mirror polished	with multi-component grips	1.3	0.8			11.0		50
77 42 115	039761	115	↘	mirror polished	with multi-component grips	0.3 - 1.3	0.8		14.0	11.0	7.5	70
77 42 130	018773	130	↘	mirror polished	with multi-component grips	0.3 - 1.6	1.3		18.0	15.0	9.5	122
77 52 115	040750	115	↘	mirror polished	with multi-component grips	0.3 - 1.0	0.8	0.5	14.0	11.0	7.5	65
77 72 115	040958	115	↘	mirror polished	with multi-component grips	0.3 - 0.8			10.5	11.0	6.0	65

Electronics Diagonal Cutters ESD

- > For fine cutting work, e.g. in electronics and fine mechanics
- > Electrically discharging handles – dissipative
- > Sturdy, zero-backlash box joint
- > Low-friction double spring for gentle and even opening
- > The mirror polish together with a fine film of oil offer effective rust protection – no circuit faults caused by peeling chrome from plated tools
- > Cutters additionally laser hardened, cutting edge hardness approx. 62 HRC
- > With two-colour dual component grips, black/grey
- > Ball bearing chrome steel, oil-hardened
- > DIN ISO 9654, DIN EN 61 340-5

77 02 115 ESD

- > Round head, with small bevel

77 12 115 ESD

- > Round head, with bevel and lead catcher – no uncontrolled loss of cut wire ends

77 22 115 ESD

- > Round head, without bevel

77 32 115 ESD

- > Pointed head, with small bevel

77 42 115 ESD

- > Pointed head, without bevel

77 52 115 ESD

- > Pointed, flat head, with small bevel

77 72 115 ESD

- > Pointed mini-head, with small bevel



77 02 115 ESD



77 12 115 ESD



77 22 115 ESD



77 32 115 ESD



77 42 115 ESD



77 52 115 ESD



77 72 115 ESD

ESD pliers (electrostatic discharge)
 Electrostatic energy is discharged through the handles in a gradual and controlled manner. Which protects components endangered by electrostatic discharge. In accordance with applicable standards, e.g. IEC TR 61 340-5, DIN EN 61 340-5, SP Method 2472

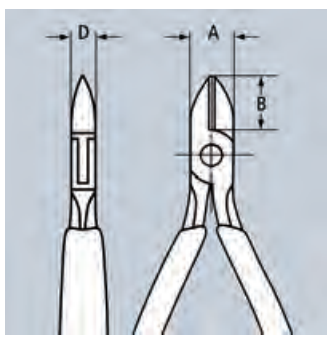

Article No.	EAN 4003773-	↔ mm	Icons	Head	Handles	Cutting capacities			Dimensions			
						Ø mm	Ø mm	Ø mm	B mm	A mm	D mm	Δ g
77 02 115 ESD	025092	115	MM ⚡	mirror polished	with multi-component grips	0.3 - 1.6	1.2	0.6	14.0	11.0	7.5	70
77 12 115 ESD	025108	115	MM ⚡ ➤	mirror polished	with multi-component grips	0.3 - 1.6	1.2	0.6	14.0	11.0	7.5	70
77 22 115 ESD	025115	115	MM ⚡	mirror polished	with multi-component grips	0.3 - 1.3	1.0		14.0	11.0	7.5	70
77 32 115 ESD	025122	115	MM ⚡	mirror polished	with multi-component grips	0.3 - 1.3	1.0	0.5	14.0	11.0	7.0	70
77 42 115 ESD	031901	115	MM ⚡	mirror polished	with multi-component grips	0.3 - 1.3	0.8		14.0	11.0	7.0	70
77 52 115 ESD	025139	115	MM ⚡	mirror polished	with multi-component grips	0.3 - 1.0	0.8	0.5	14.0	11.0	7.0	70
77 72 115 ESD	024330	115	MM ⚡	mirror polished	with multi-component grips	0.3 - 0.8			10.5	11.0	6.0	70

Electronics Diagonal Cutter

with inserted carbide metal cutting edges

- > For extreme demands on cutting pliers caused by hard or tough materials, e.g. piano, nickel, tungsten and diode wire, such as those used more frequently in the electronics and aerospace industries
- > Always the right cutting tool, even with the hardest material
- > Precision carbide metal cutting edges soldered into forged blanks
- > Sturdy, zero-backlash box joint
- > Hardness of the carbide cutting edges 80 - 83 HRC
- > Pliers with carbide metal cutting edges have a substantially longer service life than such with conventional cutting edges
- > Constantly reliable cutting results due to the avoidance of cutter deformations
- > High cost saving due to longer service life of the pliers
- > DIN ISO 9654

77 02 120 H / 77 02 135 H / ESD

- > Round head, with bevel

77 32 120 H / ESD

- > Pointed head with chamfer; with small bevel



77 02 120 H



77 02 120 H ESD



77 32 120 H



77 32 120 H ESD



Inserted carbide cutting edge

Precision carbide metal cutting edges soldered into forged blanks.

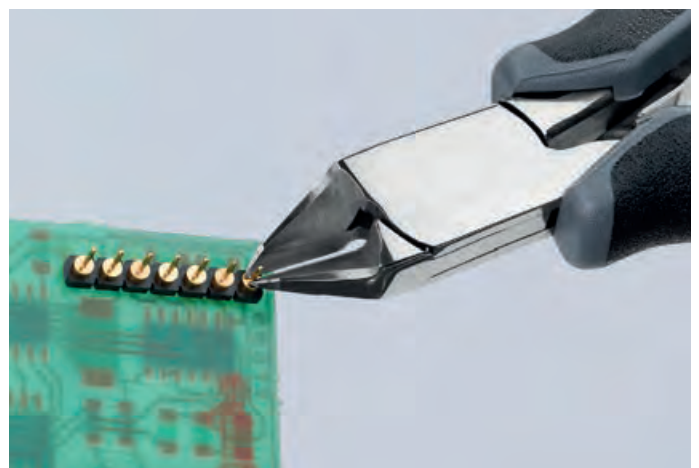

Article No.	EAN 4003773-	↔ mm	Head	Handles	Cutting capacities				Dimensions			
					Ø mm	Ø mm	Ø mm	Ø mm	B mm	A mm	D mm	Δ g
77 02 120 H	075783	120	mirror polished	with multi-component grips	2.0	1.4	1.0	0.6	14.0	11.0	7.5	85
77 02 135 H	075806	135	mirror polished	with multi-component grips	2.2	1.6	1.2	0.8	18.0	15.0	9.5	115
77 02 120 H ESD	075813	120	mirror polished	with multi-component grips	2.0	1.4	1.0	0.6	14.0	11.0	7.5	85
77 02 135 H ESD	075837	135	mirror polished	with multi-component grips	2.2	1.6	1.2	0.8	18.0	15.0	9.5	115
77 32 120 H	075790	120	mirror polished	with multi-component grips	1.6	1.0	0.6	0.2	14.0	11.0	7.5	80
77 32 120 H ESD	075820	120	mirror polished	with multi-component grips	1.6	1.0	0.6	0.2	14.0	11.0	7.0	80

Electronics End Cutting Nippers

- > Precision pliers for ultra fine cutting work, e. g. in electronics and fine mechanics
- > Sturdy, zero backlash box joint
- > Low-friction double spring for gentle and even opening
- > The mirror polish together with a fine film of oil offer effective rust protection – no circuit faults caused by peeling chrome from plated tools
- > Cutters additionally laser hardened, cutting edge hardness at least 56 HRC
- > Ball bearing chrome steel, oil-hardened
- > DIN ISO 9654

Style 0

- > End Cutter, with small bevel

Style 2

- > End Cutter, mini-blade with small bevel

Style 3

- > Oblique End Cutter, short head, with small bevel, $\alpha = 15^\circ$

Style 4

- > Oblique End Cutter, short head, with small bevel, $\alpha = 27^\circ$

Style 5

- > Oblique End Cutter, short head, without bevel, for flush cutting, $\alpha = 27^\circ$

Style 6

- > Oblique End Cutter, mini-blade with small bevel, $\alpha = 65^\circ$

Style 7

- > Oblique End Cutter, mini-blade with small bevel, head with recess, $\alpha = 35^\circ$

Style 1 / 64 11 115

- > End Cutter, without bevel

Style 1 / 64 12 115 / ESD

- > End Cutter, with small bevel



64 01 115



64 02 115



64 02 115 ESD



64 11 115



64 12 115



64 12 115 ESD



64 22 115



64 32 120

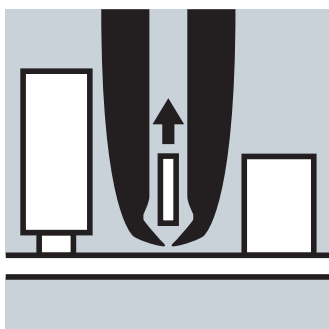

64 22 115

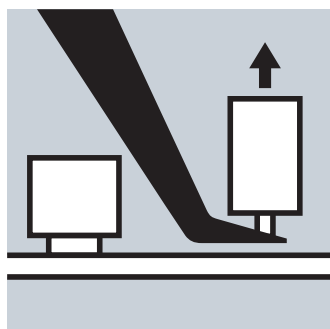

64 62 120

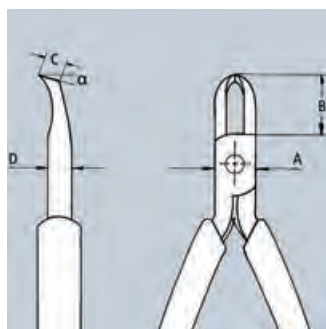

64 72 120

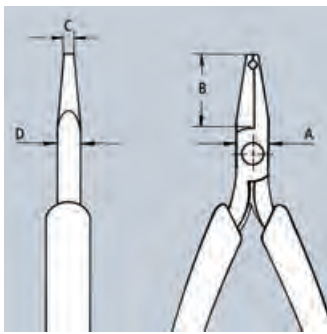

64 22 115

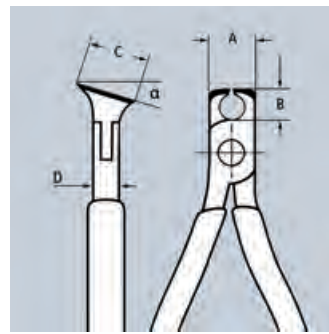

64 32/42/52

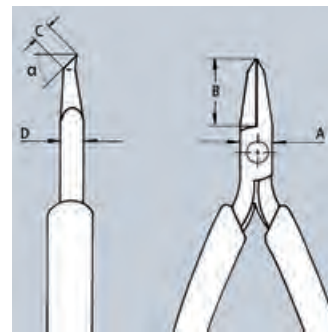

64 62 120

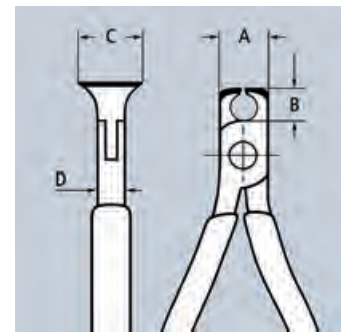

64 01/02/11/12

Article No.	EAN 4003773-	↔ mm		Style	Head	Handles	Cutting capacities			Dimensions				⚖ g
							∅ mm	∅ mm	∅ mm	A mm	B mm	D mm	C mm	
64 01 115	017745	115	MM	0	mirror polished	with non-slip plastic coating	2.0	1.0	0.6	11.0	6.0	7.5	16.0	55
64 02 115	035343	115	MM	0	mirror polished	with multi-component grips	2.0	1.0	0.6	11.0	6.0	7.5	16.0	70
64 02 115 ESD	082231	130	∠90° MM	0	mirror polished	with multi-component grips	2.0	1.0	0.6	11.0	6.0	7.5	16.0	70
64 11 115	017769	115	MM	1	mirror polished	plastic coated	1.4	0.8		11.0	12.0	7.0	16.0	50
64 12 115	040743	115	MM	1	mirror polished	with multi-component grips	1.4	0.8	0.5	11.0	6.0	7.0	16.0	70
64 12 115 ESD	024323	115	∠90° MM	1	mirror polished	with multi-component grips	1.4	0.8		11.0	6.0	7.0	16.0	70
64 22 115	017806	115	MM	2	mirror polished	with multi-component grips	0.8			11.0	20.0	6.0	3.0	70
64 22 115 ESD	025061	115	MM	2	mirror polished	with multi-component grips	0.8			11.0	20.0	6.0	3.0	70
64 32 120	017820	120	∠15° MM	3	mirror polished	with multi-component grips	1.5	1.0	0.5	11.0	10.0	7.0	17.0	70
64 32 120 ESD	025078	120	∠15° MM	3	mirror polished	with multi-component grips	1.5	1.0	0.5	11.0	10.0	7.0	17.0	70
64 42 115	017844	115	MM	4	mirror polished	with multi-component grips	1.5	1.0	0.5	11.0	10.0	7.0	12.0	70
64 52 115	040439	115	∠27° MM	5	mirror polished	with multi-component grips	1.3			11.0	10.0	7.0	12.0	70
64 62 120	046998	120	∠65° MM	6	mirror polished	with multi-component grips	0.6			11.0	20.0	7.0	7.0	70
64 62 120 ESD	025085	120	∠65° MM	6	mirror polished	with multi-component grips	0.6			11.0	20.0	7.0	7.0	70
64 72 120	017882	120	∠35° MM	7	mirror polished	with multi-component grips	1.5			11.0	20.0	7.0	6.0	70

Electronics Oblique Cutting Nipper

- > With cutting edges for soft and medium hard wire
- > Without bevel, for flush cutting
- > Cutters additionally laser hardened, cutting edge hardness approx. 56 HRC
- > Low-friction double spring for gentle and even opening
- > Sturdy, zero backlash box joint
- > The mirror polish together with a fine film of oil offer effective rust protection – no circuit faults caused by peeling chrome from plated tools
- > Ball bearing chrome steel, oil-hardened
- > DIN ISO 9654



62 12 120

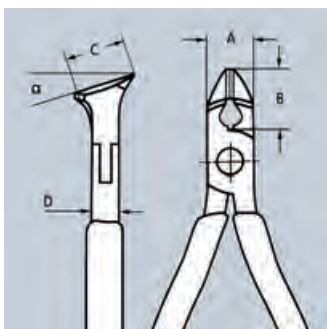

Article No.	EAN 4003773-	↔ mm		Handles	Cutting capacities		Dimensions				⚖ g
					∅ mm	∅ mm	A mm	B mm	C mm	D mm	
62 12 120	048008	120	∠15° MM	with multi-component grips	0.3 - 1.0	0.7	11.0	10.0	17.0	7.5	70

Precision Electronics Gripping Pliers

- > The assortment for highest standard of performance and results
- > Precision pliers for fine assembly work, e.g. in electronics and fine mechanics
- > For gripping, holding and bending
- > Bolted joint: precise, zero backlash operation of pliers
- > Precisely finished joint surfaces for smooth, low friction movement along the complete opening range
- > Low-friction double spring for gentle and even opening
- > Smooth ground gripping surfaces, edges carefully deburred
- > Non-reflective finish
- > Low weight
- > For very precise assembly work, e.g. in electronics and fine mechanics
- > Smoothly ground gripping surfaces, edges finely rounded
- > Approx. 20 % lighter than conventional electronics pliers
- > Bolted joint and carefully manufactured joint surfaces for even, low-friction movement throughout the entire opening range
- > Smooth-running double spring for a gentle and even opening
- > With precision laser cut cross-shaping
- > Ball bearing chrome steel, forged, multi stage oil-hardened
- > DIN ISO 9655

Style 1

- > Flat, wide jaws

Style 2

- > Half-round jaws

Style 3

- > Round, pointed jaws

Style 4

- > Flat, wide jaws, with precision laser cut cross-shaping

Style 5

- > Half-round jaws, with precision laser cut cross-shaping



34 12 130 ESD



34 12 130



34 22 130



34 22 130 ESD



34 32 130



34 32 130 ESD



34 42 130



34 42 130 ESD

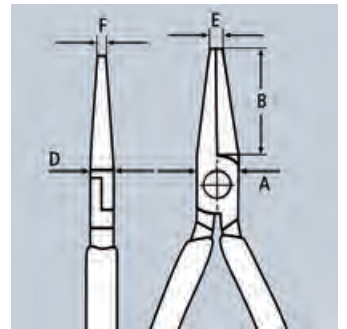

Cross-shaping: precision laser cut for a secure grip in ultra fine mounting work

Article No.	EAN 4003773-	↔ mm	Head	Handles	Dimensions					⚖ g	
					B mm	A mm	D mm	E mm	F mm		
34 12 130 ESD	061632	135	▭ ▭ ▭ ⚠	polished	with multi-component grips	21.9	11.2	6.5	1.4	3.5	62
34 12 130	061458	135	▭ ▭ ▭	polished	with multi-component grips	21.9	11.2	6.5	1.4	3.5	61
34 22 130	061472	135	▭ ⊖ ▭	polished	with multi-component grips	22.7	11.2	6.5	1.6	1.6	61
34 22 130 ESD	061656	135	▭ ⊖ ▭ ⚠	polished	with multi-component grips	22.7	11.2	6.5	1.6	1.6	65
34 32 130	061496	135	▭ 8 ▭	polished	with multi-component grips	23.7	11.2	6.5	2.0	1.0	59
34 32 130 ESD	061670	135	▭ 8 ▭ ⚠	polished	with multi-component grips	23.7	11.2	6.5	2.0	1.0	62
34 42 130	080282	130	▭ ▭ ▭ ▭	polished	with multi-component grips	21.9	11.2	6.5	1.4	3.5	61
34 42 130 ESD	080299	130	▭ ▭ ▭ ▭ ⚠	polished	with multi-component grips	21.9	11.2	6.5	1.4	3.5	61
34 52 130	080312	130	▭ ⊖ ▭	polished	with multi-component grips	22.7	11.2	6.5	1.6	1.6	61
34 52 130 ESD	080305	130	▭ ⊖ ▭ ⚠	polished	with multi-component grips	22.7	11.2	6.5	1.6	1.6	61

Electronics Pliers

- > Precision pliers for fine assembly work, e.g. in electronics and fine mechanics
- > Load-optimised for a more direct feel when working
- > For gripping, holding and bending
- > Sturdy, zero backlash box joint
- > Smooth ground gripping surfaces
- > Soft transitions; no sharp edges
- > Low-friction double spring for gentle and even opening
- > The mirror polish together with a fine film of oil offer effective rust protection – no circuit faults caused by peeling chrome from plated tools
- > Narrow sleeves pulled up to the head of the pliers enable the tool to be guided securely and comfortably, also between thumb and index finger
- > Edges carefully deburred
- > Ball bearing chrome steel, oil-hardened
- > DIN ISO 9655



35 11 115



35 12 115



35 21 115



35 22 115



35 31 115



35 32 115



35 41 115



35 42 115

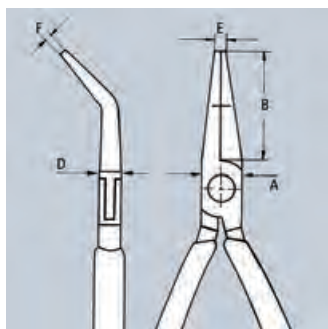
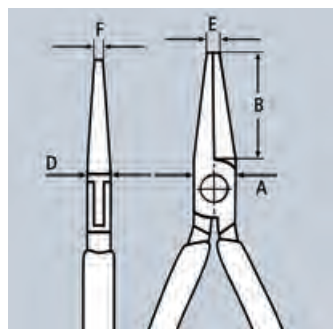

Article No.	EAN 4003773-	↔ mm		Head	Handles	Dimensions					⚖ g
						B mm	A mm	D mm	E mm	F mm	
35 11 115	016694	115		mirror polished	with non-slip plastic coating	22.5	11.0	6.5	2.0	4.0	55
35 12 115	035107	115		mirror polished	with multi-component grips	22.5	11.0	6.5	2.0	4.0	70
35 21 115	016724	115		mirror polished	with non-slip plastic coating	22.5	11.0	6.5	2.0	1.5	55
35 22 115	035114	115		mirror polished	with multi-component grips	22.5	11.0	6.5	2.0	1.5	70
35 31 115	016762	115		mirror polished	with non-slip plastic coating	22.5	11.0	6.5	2.0	1.0	61
35 32 115	035121	115		mirror polished	with multi-component grips	22.5	11.0	6.5	2.0	1.0	70
35 41 115	082248	115		mirror polished	with multi-component grips	22.5	11.0	6.5	2.0	1.0	55
35 42 115	040736	115		mirror polished	with multi-component grips	22.5	11.0	6.5	2.0	1.5	70
35 52 145	039389	145		mirror polished	with multi-component grips	40.0	12.0	7.5	1.5	4.0	102
35 62 145	039556	145		mirror polished	with multi-component grips	40.0	12.0	7.5	2.5	1.5	103
35 72 145	043607	145		mirror polished	with multi-component grips	40.0	12.0	7.5	2.5	1.3	98
35 82 145	039396	145		mirror polished	with multi-component grips	35.0	12.0	7.5	2.5	1.0	102

Electronics Pliers ESD

- > Precision pliers for fine assembly work, e.g. in electronics and fine mechanics
- > For gripping, holding and bending
- > Electrically discharging handles - dissipative
- > Sturdy, zero backlash box joint
- > Smooth ground gripping surfaces
- > Edges carefully deburred
- > Low-friction double spring for gentle and even opening
- > The mirror polish together with a fine film of oil offer effective rust protection – no circuit faults caused by peeling chrome from plated tools
- > With two-colour dual component grips, black/grey
- > Ball bearing chrome steel, oil-hardened
- > DIN ISO 9655, DIN EN 61 340-5

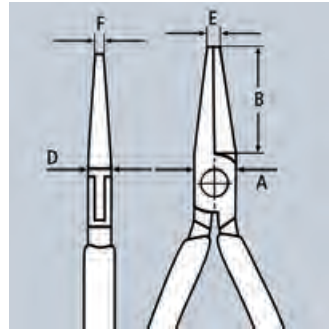
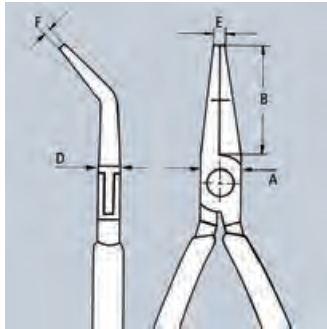

35 12 115 ESD



35 22 115 ESD



35 32 115 ESD



35 42 115 ESD

ESD pliers (electrostatic discharge)

Electrostatic energy is discharged through the handles in a gradual and controlled manner. Which protects components endangered by electrostatic discharge. In accordance with applicable standards, e.g. IEC TR 61 340-5, DIN EN 61 340-5, SP Method 2472



Article No.	EAN 4003773-	↔ mm	Head	Handles	Dimensions					⚖ g
					B mm	A mm	D mm	E mm	F mm	
35 12 115 ESD	024835	115	mirror polished	with multi-component grips	22.5	11.0	6.5	2.0	4.0	70
35 22 115 ESD	024842	115	mirror polished	with multi-component grips	22.5	11.0	7.0	2.0	1.3	70
35 32 115 ESD	024859	115	mirror polished	with multi-component grips	22.5	11.0	6.5	2.0	1.0	70
35 42 115 ESD	024866	115	mirror polished	with multi-component grips	22.5	11.0	6.5	2.0	1.5	70

Electronics Mounting Pliers

- > Precision pliers for very fine assembly and repair work in electronics
- > For bending and cutting off wire ends on components
- > Sturdy, zero backlash box joint
- > Smooth ground gripping surfaces
- > Edges carefully deburred
- > Low-friction double spring for gentle and even opening
- > The mirror polish together with a fine film of oil offer effective rust protection – no circuit faults caused by peeling chrome from plated tools
- > Ball bearing chrome steel, oil-hardened



36 12 130



36 22 125



36 32 125

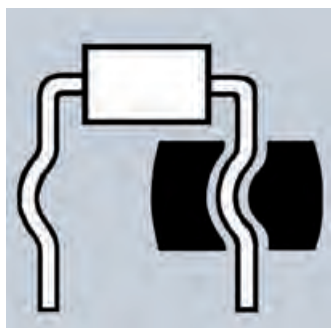
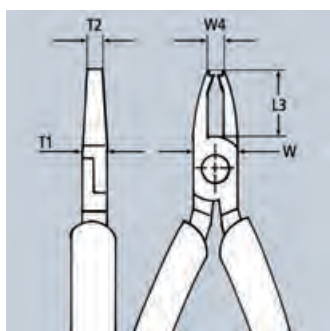
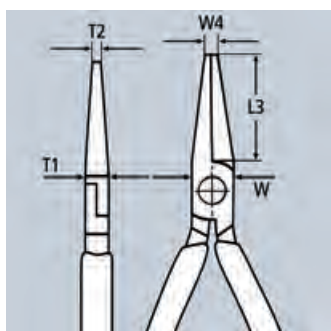
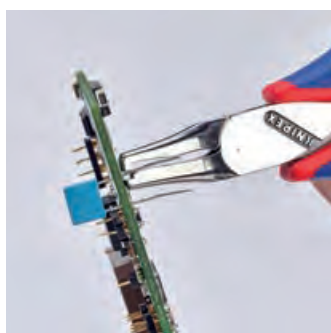

To bend wire in shape for the distance to the board

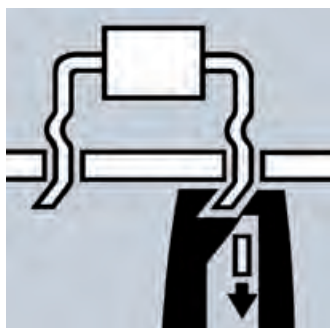

To bend and cut wire at 1.6 mm length below the board

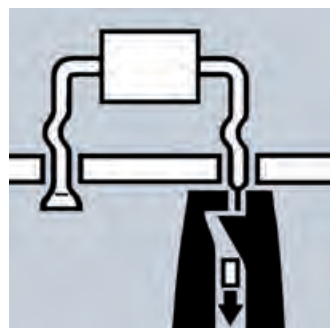

To crunch and cut wire at 1.6 mm length below the board

Article No.	EAN 4003773-	↔ mm		Head	Handles	Cutting capacities		Dimensions					△ g
						⊙ Ø mm	⊙ Ø mm	L3 mm	W mm	T1 mm	W1 mm	T2 mm	
36 12 130	016861	130	⌘	mirror polished	with multi-component grips			18.0	11.0	7.0	5.5	4.0	70
36 22 125	046967	125	⌘	mirror polished	with multi-component grips	1.2		18.0	11.0	7.0	7.5	4.0	94
36 32 125	016885	125	⌘	mirror polished	with multi-component grips	1.0		18.0	11.0	7.0	7.5	3.0	108

Electronics Pliers Sets

with tools for work on electronic components

> Dimensions, closed (W x H x D): 215 x 160 x 50 mm

00 20 16

> 7 parts, contains 6 electronics pliers and one pair of precision tweezers; case made of hard-wearing polyester fabric, pliers are held by elastic band, zippered



00 20 16



00 20 16 P

00 20 16 P

> 6 parts, contains 6 precision electronics pliers; case made of hard-wearing polyester fabric, pliers are held by elastic band, zippered

00 20 16 P ESD

> 6 parts, contains 6 ESD precision electronics pliers, electrically discharging version; case made of hard-wearing polyester fabric, pliers are held by elastic band, zippered

00 20 17

> 6 parts, contains 6 ESD precision electronics pliers, electrically discharging version; case made of hard-wearing polyester fabric, pliers are held by elastic band, zippered



00 20 16 P ESD



00 20 17

00 20 18

> 8 parts, contains 2 electronics pliers and 6 electronics screwdrivers; practical storage box, shock-resistant plastic, with foam insert

00 20 18 ESD

> 8 parts, contains 2 electronics pliers and 6 electronics screwdrivers, ESD electrically discharging version; practical storage box, shock-resistant plastic, with foam insert



00 20 18



00 20 18 ESD

Article No.	EAN 4003773-	Contents	g
00 20 16	022619	35 12 115 / 35 22 115 / 35 32 115 / 64 32 120 / 77 02 115 / 77 42 115 / 92 34 36	720
00 20 16 P	063223	34 12 130 / 34 22 130 / 34 32 130 / 79 02 120 / 79 02 120 / 79 02 125 / 79 42 125	575
00 20 16 P ESD	063230	34 12 130 ESD / 34 22 130 ESD / 34 32 130 ESD / 79 02 120 ESD / 79 02 125 ESD / 79 42 125 ESD	585
00 20 17	031222	35 12 115 ESD / 35 22 115 ESD / 35 42 115 ESD / 64 32 120 ESD / 77 02 115 ESD / 77 32 115 ESD	695
00 20 18	033073	35 22 115 / 77 02 115 / screw drivers 0,4 x 2,5 / 0,5 x 3,0 / 0,6 x 3,5 / 0,8 x 4,0 / PH0 / PH1	460
00 20 18 ESD	051848	35 22 115 ESD / 77 02 115 ESD / screw drivers 0,4 x 2,5 / 0,5 x 3,0 / 0,6 x 3,5 / 0,8 x 4,0 / PH0 / PH1	465

Precision Tweezers

- > Smooth gripping surfaces
- > Non-reflective matt finish

92 02 53

- > For SMD-technology*; angled tips, width approx. 1 mm; gripping surfaces matt finished for optimum grip; chrome nickel steel: stainless, anti-magnetic (18/10), very popular electronics quality

92 02 54

- > For SMD-technology*; angled tips, width approx. 1 mm; with integrated profile for reliable gripping of cylindrical components of 0.6 mm dia.; gripping surfaces matt finished for optimum grip; chrome nickel steel: stainless, anti-magnetic (18/10), very popular electronics quality

92 02 55

- > Gripping jaws 3.5 mm wide, for cylindrical components of 0.8 mm dia.; serrated handles; stainless, anti-magnetic and acid-proof

92 12 52

- > Angled tips; extra strong tips; stainless, anti-magnetic



92 02 53



92 02 54



92 02 55



92 12 52

Article No.	EAN 4003773-	↔ mm		Finish	⚖ g
92 02 53	054603	120	∠45°	stainless, anti-magnetic	16
92 02 54	054610	120	∠45°	stainless, anti-magnetic	15
92 02 55	054627	115		stainless, anti-magnetic, acid-proof	16
92 12 52	054658	120	∠85°	stainless, anti-magnetic	20

Precision Tweezers

pointed shape

- > For fine mounting work
- > Straight pattern
- > Smooth gripping surfaces
- > Particularly slim tips

92 22 04

- > Non-reflective matt finish; gripping surfaces matt finished for optimum grip; chrome nickel steel: stainless, anti-magnetic (18/10), very popular electronics quality

92 22 06

- > Non-reflective matt finish; gripping surfaces matt finished for optimum grip; chrome nickel steel: stainless, anti-magnetic (18/10), very popular electronics quality

92 22 07

- > Non-reflective matt finish; stainless, anti-magnetic and acid-proof

92 23 05

- > Titanium; electrically conductive; lightweight; non-reflective matt finish; stainless, anti-magnetic and acid-proof

92 24 01

- > Spring steel, chrome plated



92 22 04



92 22 06



92 22 07



92 23 05



92 24 01

Article No.	EAN 4003773-	↔ mm		Finish	⚖ g
92 22 04	054665	130	∠	stainless, anti-magnetic	20
92 22 06	054672	120	∠	stainless, anti-magnetic	15
92 22 07	054689	115	∠	stainless, anti-magnetic, acid-proof	12
92 23 05	054726	120	∠	Titanium, anti-magnetic, acid-proof, stainless	10
92 24 01	054733	120	∠	spring steel, chrome plated	15

Precision Tweezers

needle-pointed shape

- > For ultra fine mounting work
- > Extra fine tips
- > Smooth gripping surfaces
- > Stainless, anti-magnetic
- > Non-reflective matt finish

92 22 12

- > Straight pattern

92 34 28

- > Angled tips

92 22 13

- > American shape, solid; straight pattern; stainless, anti-magnetic and acid-proof

92 32 29

- > Sickle-shaped tips; Chrome nickel steel: stainless, anti-magnetic (18/10), very popular electronics quality; gripping surfaces matt finished for optimum grip



92 22 12



92 22 13



92 32 29



92 34 28

Article No.	EAN 4003773-	↔ mm		Finish	⚖ g
92 22 12	054696	105		stainless, anti-magnetic	13
92 22 13	054702	135		stainless, anti-magnetic, acid-proof	21
92 32 29	054818	120		stainless, anti-magnetic	16
92 34 28	054825	105		stainless, anti-magnetic	12

Precision Tweezers

with centering pin

pointed shape

- > Universally applicable
- > Narrow tips
- > Gripping surfaces with fine transverse serration
- > Serrated handles

92 34 37

- > Angled tips; black non-reflective lacquered

92 24 36

- > Angled tips; spring steel, chrome plated

92 24 34

- > Straight pattern; spring steel, chrome plated

92 22 35

- > Straight pattern; non-reflective matt finish; stainless, anti-magnetic and acid-proof



92 22 35



92 24 34



92 34 36



92 34 37

Article No.	EAN 4003773-	↔ mm		Finish	⚖ g
92 22 35	054719	155		stainless, anti-magnetic, acid-proof	22
92 24 34	054740	155		spring steel, chrome plated	21
92 34 36	054832	155		spring steel, chrome plated	23
92 34 37	054849	155		black lacquered	21

Precision Tweezers

round slim shape

- > Round tips, approx. 2 mm wide
- > Smooth gripping surfaces
- > Stainless, anti-magnetic and acid-proof
- > Chrome nickel steel, stainless, anti-magnetic, acid-proof



92 52 23

Article No.	EAN 4003773-	↔ mm		Finish	⚖ g
92 52 23	054894	120		stainless, anti-magnetic, acid-proof	17

Precision Tweezers

blunt shape

- > Universally applicable
- > Straight pattern
- > Wide, round tips
- > Serrated handles

92 44 42

- > Jewellers' tweezers; round tips, approx. 2 mm wide; gripping jaws with fine crosswise serration (cross-hatched); spring steel, chrome plated

92 64 43

- > Round tips, approx. 3.0 mm wide; gripping surfaces with fine transverse serration; spring steel, chrome plated

92 64 44

- > Round tips, approx. 3.5 mm wide, gripping surfaces with fine transverse serration

92 72 45

- > Round tips, approx. 3.5 mm wide; knurled gripping surfaces; non-reflective matt finish; stainless, anti-magnetic and acid-proof



92 44 42



92 64 43



92 64 44



92 70 46



92 72 45

Article No.	EAN 4003773-	↔ mm		Finish	⚖ g
92 44 42	054887	155		spring steel, chrome plated	21
92 64 43	054917	120		spring steel, chrome plated	17
92 64 44	054924	145		spring steel, chrome plated	23
92 70 46	055075	145		black lacquered	26
92 72 45	054962	145		stainless, anti-magnetic, acid-proof	27

Plastic Tweezers

- > Solid plastic tweezers
- > Trapezoidal tips, approx. 3.5 mm wide
- > Knurled gripping surfaces
- > Serrated handles
- > Heat resistant up to approx. 130° C
- > Tweezers body: solid plastic, temperature-resistant up to 130°C



92 69 84

Article No.	EAN 4003773-	↔ mm		Finish	⚖ g
92 69 84	054948	130		plastic	19

Precision Tweezers

rectangular blunt

- > Mounting tweezers
- > Rectangular tips, approx. 0.9 mm wide
- > Gripping surfaces with fine transverse serration
- > Nickel plated
- > Spring steel, high-strength



92 84 18

Article No.	EAN 4003773-	↔ mm		Finish	⚖ g
92 84 18	054986	125		spring steel, chrome plated	19

Cross-Over Tweezers

- > For holding small parts without finger pressure
- > For efficient clamping
- > Nickel plated
- > Spring steel, high-strength

92 94 91

- > Trapezoidal tips; straight pattern; gripping surfaces with fine transverse serration; serrated handles

92 95 89

- > Narrow tips; straight pattern; gripping surfaces with fine transverse serration; handles with plastic attachment

92 95 90

- > Narrow tips; angled tips; gripping surfaces with fine transverse serration; handles with plastic attachment



92 94 91



92 95 89



92 95 90

Article No.	EAN 4003773-	↔ mm		Finish	⚖ g
92 94 91	055006	160		spring steel, chrome plated	35
92 95 89	055013	160		spring steel, chrome plated	30
92 95 90	055020	160	$\angle 45^\circ$	spring steel, chrome plated	32

Precision Tweezers

insulated

- > With dipped insulation
- > Spring steel, high-strength
- > DIN EN 60900, IEC 60900

92 27 61

- > For ultra fine mounting work; extra fine tips; straight pattern; gripping surfaces matt finished for optimum grip

92 27 62

- > Straight pattern; gripping surfaces with fine transverse serration

92 37 64

- > Angled tips; gripping surfaces with fine transverse serration

92 67 63

- > Straight pattern; knurled gripping surfaces



92 27 61



92 27 62



92 37 64



92 67 63

Article No.	EAN 4003773-	↔ mm		Finish	⚖ g
92 27 61	054757	130	$\triangle 1000V$	with dipped insulation	30
92 27 62	054764	150	$\triangle 1000V$	with dipped insulation	35
92 37 64	054856	150	$\triangle 1000V \angle 45^\circ$	with dipped insulation	34
92 67 63	054931	145	$\triangle 1000V$	with dipped insulation	40

Precision Tweezers ESD

- > Chrome nickel steel: stainless, anti-magnetic (18/10), very popular electronics quality
- > ESD coating: non-reflective black, with a surface resistance of approx. 10^5 Ohm
- > Tips non-reflective brushed
- > Gripping surfaces matt finished for optimum grip
- > Chrome nickel steel, stainless, anti-magnetic

92 08 78 ESD

- > For SMD-technology*; angled tips; smooth gripping surfaces

92 08 79 ESD

- > Shaped to grip horizontal cylindrical components of 1.0 mm dia.; smooth gripping surfaces; serrated handles

92 28 69 ESD

- > Straight pattern; strong tip; smooth gripping surfaces

92 28 70 ESD

- > Straight pattern; fine tip; smooth gripping surfaces

92 28 71 ESD

- > Needle-pointed tips; straight pattern; smooth gripping surfaces

92 28 72 ESD

- > American shape, solid; long tips; straight pattern; smooth gripping surfaces

92 38 75 ESD

- > Sickle-shaped tips; smooth gripping surfaces

92 58 74 ESD

- > Round tips, approx. 2 mm wide; straight pattern; smooth gripping surfaces

92 58 77 ESD

- > Round tips, approx. 3.5 mm wide; straight pattern; knurled gripping surfaces; serrated handles

92 88 73 ESD

- > Rectangular tips, approx. 0.9 mm wide; gripping surfaces with fine transverse serration



92 08 78 ESD



92 08 79 ESD



92 28 69 ESD



92 28 70 ESD



92 28 71 ESD

























92 28 72 ESD



92 38 75 ESD



92 58 74 ESD

Article No.	EAN 4003773-	↔ mm	 $\angle 45^\circ$ 	Finish	 g
92 08 78 ESD	054634	120	 $\angle 45^\circ$ 	stainless, anti-magnetic, electrically dissipative	16
92 08 79 ESD	054641	120	 	stainless, anti-magnetic, electrically dissipative	16
92 28 69 ESD	054771	130	 	stainless, anti-magnetic, electrically dissipative	20
92 28 70 ESD	054788	110	 	stainless, anti-magnetic, electrically dissipative	13
92 28 71 ESD	054795	110	 	stainless, anti-magnetic, electrically dissipative	14
92 28 72 ESD	054801	135	 	stainless, anti-magnetic, electrically dissipative	22
92 38 75 ESD	054863	120	 $\angle 45^\circ$ 	stainless, anti-magnetic, electrically dissipative	17
92 58 74 ESD	054900	120	 	stainless, anti-magnetic, electrically dissipative	19
92 78 77 ESD	054979	145	 	stainless, anti-magnetic, electrically dissipative	27
92 88 73 ESD	054993	130	 	stainless, anti-magnetic, electrically dissipative	20

* SMD-Technology: technique for soldering surface mounted components on printed circuit boards without using holes

Pliers with tether attachment point for mounting a fall protection



Pliers range with tether attachment point
for mounting a fall protection

266







The tether attachment point for the range with multi-component handles

Tools can fall down when used on cherry pickers, scaffolding and ladders and when used by industrial climbers working with wire rope hoists.

KNIPEX offers a range of pliers and accessories that can reliably prevent the KNIPEX pliers from falling down.



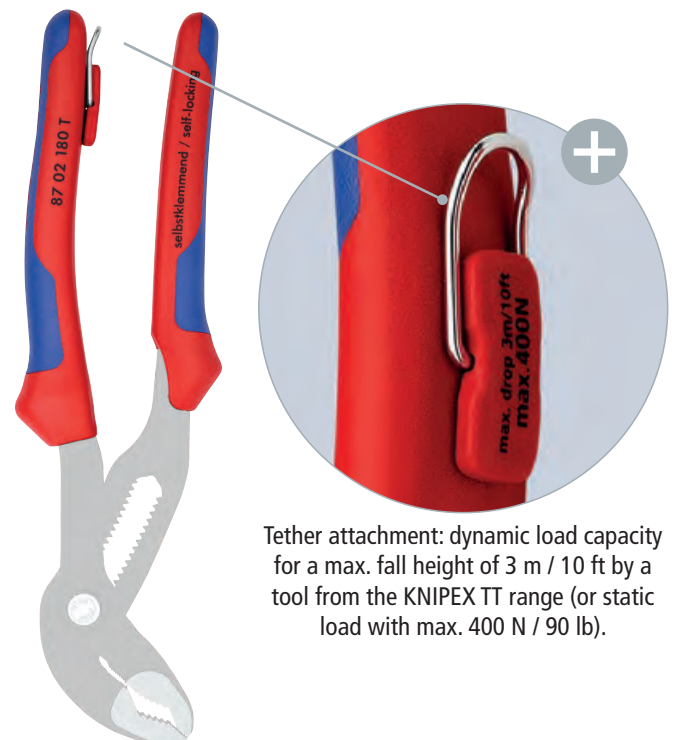















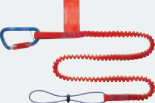





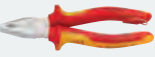



There is a very stable tether on the inside of the handles which is welded tightly to the handle for attaching the tether or adapter strap. The lug enables the equipment to be attached and put down quickly. The sophisticated elements from our KNIPEX Tethered Tools Program offer several individual permutations for connection and use.





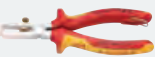









Tether attachment: dynamic load capacity for a max. fall height of 3 m / 10 ft by a tool from the KNIPEX TT range (or static load with max. 400 N / 90 lb).



PLIERS WITH TETHER ATTACHMENT POINT

	Article No.	Designation	page		Article No.	Designation	page
	00 50 01 T BK	Tether			13 66 180 T	KNIPEX StriX® Insulation strippers, with cable shears, insulated, with multi-component grips, VDE-tested, with integrated tether attachment point for a tool tether	35, 201
	00 50 02 T BK	Adapter Strap			13 82 200 T	Pliers for Electrical Installation, with multi-component grips, with integrated tether attachment point for a tool tether	10
	00 50 03 T BK	Carabiner			13 96 200 T	Pliers for Electrical Installation, insulated, with multi-component grips, VDE-tested, with integrated tether attachment point for a tool tether	10, 204
	00 50 04 T BK	Tethering System Set			25 06 160 T	Snipe Nose Side Cutting Pliers (Radio Pliers), insulated, VDE-tested, with integrated tether attachment point for a tool tether, DIN ISO 5745	15, 205
	00 50 05 T BK				26 12 200 T	Snipe Nose Side Cutting Pliers (Stork Beak Pliers), with multi-component grips, with integrated tether attachment point for a tool tether, DIN ISO 5745	16
	00 50 06 T BK				26 15 200 T	Snipe Nose Side Cutting Pliers (Stork Beak Pliers), with multi-component grips, with integrated tether attachment point for a tool tether, DIN ISO 5745	16
	02 02 225 T	High Leverage Combination Pliers, with multi-component grips, with integrated tether attachment point for a tool tether, DIN ISO 5746	5		26 16 200 T	Snipe Nose Side Cutting Pliers (Stork Beak Pliers), insulated, with multi-component grips, VDE-tested, with integrated tether attachment point for a tool tether, DIN ISO 5745	16, 206
	03 06 180 T	Combination Pliers, insulated, with multi-component grips, VDE-tested, with integrated tether attachment point for a tool tether, DIN ISO 5746	5, 199		26 22 200 T	Snipe Nose Side Cutting Pliers (Stork Beak Pliers), with multi-component grips, with integrated tether attachment point for a tool tether, DIN ISO 5745	16
	08 22 145 T	Needle-Nose Combination Pliers, with multi-component grips, with integrated tether attachment point for a tool tether, DIN ISO 5746	6		26 25 200 T	Snipe Nose Side Cutting Pliers (Stork Beak Pliers), with multi-component grips, with integrated tether attachment point for a tool tether, DIN ISO 5745	16
	08 26 145 T	Needle-Nose Combination Pliers, insulated, with multi-component grips, VDE-tested, with integrated tether attachment point for a tool tether, DIN ISO 5746	6, 200		26 26 200 T	Snipe Nose Side Cutting Pliers (Stork Beak Pliers), with multi-component grips, with integrated tether attachment point for a tool tether, DIN ISO 5745	16, 206
	09 02 240 T	Lineman's Pliers, American style, with multi-component grips, with integrated tether attachment point for a tool tether, DIN ISO 5746	9		38 35 200 T	Mechanics' Pliers, with multi-component grips, with integrated tether attachment point for a tool tether, DIN ISO 5745	53
	09 12 240 T	Lineman's Pliers, American style, with slim multi-component grips, with integrated tether attachment point for a tool tether, DIN ISO 5746	9		70 05 180 T	Diagonal Cutter, with multi-component grips, with integrated tether attachment point for a tool tether, DIN ISO 5749	85
	11 06 160 T	Insulation Stripper with opening spring, insulated, with multi-component grips, VDE-tested, with integrated tether attachment point for a tool tether	20, 200		70 05 160 T	Diagonal Cutter, insulated, with multi-component grips, VDE-tested, with integrated tether attachment point for a tool tether, DIN ISO 5749	85, 208
	13 05 160 T	Electricians' Pliers, with multi-component grips, with integrated tether attachment point for a tool tether	12		70 06 180 T	Diagonal Cutter, insulated, with multi-component grips, VDE-tested, with integrated tether attachment point for a tool tether, DIN ISO 5749	85, 208
					70 06 160 T	Diagonal Cutter, insulated, with multi-component grips, VDE-tested, with integrated tether attachment point for a tool tether, DIN ISO 5749	85, 208

	Article No.	Designation	page
	71 02 200 T	KNIPEX CoBolt® Compact Bolt Cutters, with slim multi-component grips, with integrated tether attachment point for a tool tether	94
	71 22 200 T		95
	71 32 200 T		95
	73 05 160 T	KNIPEX X-Cut® Compact Diagonal Cutter, with multi-component grips, with integrated tether attachment point for a tool tether, DIN ISO 5749	87
	73 06 160 T	KNIPEX X-Cut® Compact Diagonal Cutter, insulated, with multi-component grips, VDE-tested, with integrated tether attachment point for a tool tether, DIN ISO 5749	87, 209
	74 02 200 T	High Leverage Diagonal Cutter, with multi-component grips, with integrated tether attachment point for a tool tether, DIN ISO 5749	88
	74 02 250 T		88
	74 06 200 T	High Leverage Diagonal Cutter, insulated, with multi-component grips, VDE-tested, with integrated tether attachment point for a tool tether, DIN ISO 5749	88, 209
	74 06 250 T		88, 209
	74 22 200 T	High Leverage Diagonal Cutter, with multi-component grips, with integrated tether attachment point for a tool tether, DIN ISO 5749	88
	74 22 250 T		88
	86 05 180 T	Pliers Wrench, Pliers and a wrench in a single tool, with multi-component grips, with integrated tether attachment point for a tool tether	104
	86 05 250 T		104
	87 02 180 T	KNIPEX Cobra® Hightech Water Pump Pliers, with multi-component grips, with integrated tether attachment point for a tool tether, DIN ISO 8976	110
	87 02 300 T	KNIPEX Cobra® Hightech Water Pump Pliers, with multi-component grips, with integrated tether attachment point for a tool tether, DIN ISO 8976	110
	87 02 250 T		110
	87 26 250 T	KNIPEX Cobra® VDE Hightech Water Pump Pliers, insulated, VDE-tested, with integrated tether attachment point for a tool tether, DIN ISO 8976	115, 211

	Article No.	Designation	page
	88 02 250 T	KNIPEX Alligator® Water Pump Pliers, with slim multi-component grips, with integrated tether attachment point for a tool tether, DIN ISO 8976	116
	88 02 300 T	KNIPEX Alligator® Water Pump Pliers, with multi-component grips, with integrated tether attachment point for a tool tether, DIN ISO 8976	116
	95 12 165 T	Cable Shears, with multi-component grips, with integrated tether attachment point for a tool tether	150
	95 16 165 T	Cable Shears, insulated, with multi-component grips, VDE-tested, with integrated tether attachment point for a tool tether	150, 213
	95 62 190 T	Wire Rope Cutter, forged, with multi-component grips, with integrated tether attachment point for a tool tether	160
	97 78 180 T	Crimping Pliers for wire ferrules, insulated, with multi-component grips, VDE-tested, with integrated tether attachment point for a tool tether	184, 260

Tool Assortment and Cases



Tool Roll	270
Set of pliers wrenches	271
KNIPEX Cobra® Set	271
Set of Circlip Pliers	272
Mini pliers sets	274
Case for Electronics Pliers	276
Pliers Sets	277
Precision Circlip Pliers Set	278
Set of Circlip Pliers	278
Extension sets Electro	279
Tool Kits	280
Tool Box "RED" Electro	284
Tool Box "SRZ" Precision Circlip Pliers	285
Tool Case "Basic"	286
Tool Case "BIG Basic Move"	288
Tool Case "BIG Basic Move" Electro	290
Tool Case „BIG Basic Move" Electro Plus	291
Tool Case "BIG Basic Move" Mechanics	292
Tool Case "BIG Basic Move" Sanitary	293
Tool Case "BIG Twin Move"	296
Tool Case "BIG Twin Move" Electro	297
Tool Case "BIG Twin"	294
Tool Case "BIG Twin" Electro	299
Tool Case "BIG Twin Move Red"	300
Tool Case "Robust"	302
Tool Case "Robust23" Electro	304
Tool Case "Robust34" Electro	306
Tool Case "Robust45 Move" Electro	308
Tool Case "Robust45 Move" Mechanics	310
Tool Case "Vision24" Electro	312
Tool Case "Vision27" Sanitary	313
Tool Case "Focus" Electro	314
KNIPEX L-BOXX®	315
KNIPEX L-BOXX® Electro	316
KNIPEX L-BOXX® Sanitary	317
Tool bag "Classic" Electro	318
Tool bag "Kompakt" Electric	319
Crimp Assortments	320
Tool Case for Photovoltaics	322
Compact Tool Case	324
Tool bags	326





















Tool Roll

Essential for work on electrical systems: 15-piece basic tool kit in practical roll-up bag

- > Tool roll made of hard-wearing polyester fabric
- > With practical, adjustable quick release fastener
- > Equipped with a range of insulated KNIPEX tools for works on electrical installations
- > Dimensions, open (L x H): 830 x 310 mm



98 99 13

Article No.	EAN				Number	g
98 99 13	4003773-026648			Tool Roll, 15 parts		2455
		  	03 07 200	Combination Pliers	1	
		  	11 07 160	Insulation Stripper	1	
		 	26 17 200	Snipe Nose Side Cutting Pliers (Stork Beak Pliers)	1	
			70 07 160	Diagonal Cutter	1	
			95 17 200	Cable Shears with twin cutting edge	1	
			98 00 10		1	
			98 00 13		1	
		 	98 00 14	Open-end wrench	1	
			98 00 17		1	
			98 00 19		1	
			98 20 25		1	
		  	98 20 40	Screwdrivers for slotted screws	1	
			98 20 55		1	
			98 20 65		1	
		  	98 52	Cable Knife	1	
98 99 13 LE	028888	Tool Roll, empty				325







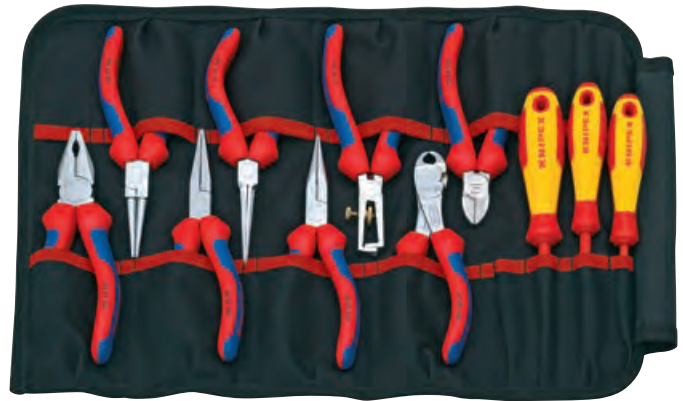









Tool Roll

Handy, ideally equipped: 11-piece set of tools for telecommunications and electrical engineers

- > For telecommunications and electrical engineers
- > Tool roll made of hard-wearing polyester fabric
- > With practical, adjustable quick release fastener
- > Contains eight pliers and three screwdrivers
- > Pliers with chrome-plated heads and two-colour multi-component handles
- > Screwdrivers VDE-tested according to DIN EN/IEC 60900 1000V
- > Dimensions, open (L x H): 450 x 290 mm



00 19 41

Article No.	EAN				Number	g
00 19 41	4003773-024729			Tool Roll, 11 parts		1620
		 	03 05 160	Combination Pliers	1	
			11 05 160	Insulation Stripper	1	
		 	25 05 160	Snipe Nose Side Cutting Pliers (Radio Pliers)	1	
			30 15 160	Long Nose Pliers	1	
			30 35 160		1	
			31 15 160	Flat Nose Pliers (Needle-Nose Pliers)	1	
			67 05 140	High Leverage End Cutting Nipper	1	
			70 05 140	Diagonal Cutter	1	
		  	98 20 25	Screwdrivers for slotted screws	1	
			98 20 40		1	
		  	98 24 01	Screwdrivers for cross-recessed screws, Phillips®	1	
00 19 41 LE	035930	Tool Roll, empty				205

Set of pliers wrenches

All-purpose tool in a set: five pliers wrenches in space-saving roll-up bag

- > Tool roll made of hard-wearing polyester fabric
- > With hook-and-loop fastener
- > Equipped with wrenches in five different lengths from 125 to 300 mm
- > Dimensions, open (L x H): 430 x 325 mm



00 19 55 54

Article No.	EAN 4003773-			Number	g
00 19 55 54	077817		Set of pliers wrenches, 5 parts		2015
		▱	86 03 125	1	Pliers Wrench, Pliers and a wrench in a single tool
		▱	86 03 150	1	
		▱	86 03 180	1	
		▱	86 03 250	1	
		▱	86 03 300	1	
00 19 55 54 LE	077824		Roll-up case for pliers wrenches, empty		260

KNIPEX Cobra® Set

Gripping set for professionals: five KNIPEX Cobra® pliers in hard-wearing roll-up bag

- > High-quality roll-up bag made from durable polyester fabric
- > With hook-and-loop fastener
- > Equipped with KNIPEX Cobra® high-tech water pump pliers in five different lengths from 125 to 300 mm
- > Dimensions, open (L x H): 430 x 325 mm



00 19 55 55

Article No.	EAN 4003773-			Number	g
00 19 55 55	082613		KNIPEX Cobra® Set, 5 parts		1575
		▱	87 01 125	1	KNIPEX Cobra® Hightech Water Pump Pliers
		▱	87 01 150	1	
		▱	87 01 180	1	
		▱	87 01 250	1	
		▱	87 01 300	1	
00 19 55 55 LE	082620		Tool Roll for KNIPEX Cobra®, empty		260

Set of Circlip Pliers

Compactly packed: four-piece circlip plier sets in practical roll-up bag

- > Tool roll made of hard-wearing polyester fabric
- > With practical, adjustable quick release fastener
- > Dimensions, open (L x H): 315 x 275 mm



00 19 56



00 19 57



00 19 56 V01



00 19 57 V01

Article No.	EAN			Style	Capacity Ø mm	Tips Ø mm	Number	g
00 19 56	4003773-030973		Circlip Pliers Set, 4 parts					670
		⊙	44 11 J2	Circlip Pliers for internal circlips in bore holes	straight tips	19 - 60	1.8	1
		⊙ ∠90°	44 21 J21		angled tips	19 - 60	1.8	1
		⊙ /MM	46 11 A2	Circlip Pliers for external circlips on shafts	straight tips	19 - 60	1.8	1
		⊙ ∠90° /MM	46 21 A21		angled tips	19 - 60	1.8	1
00 19 56 V01	081548		Circlip Pliers Set, 4 parts					615
		⊙	44 11 J1	Circlip Pliers for internal circlips in bore holes	straight tips	12 - 25	1.3	1
		⊙	44 11 J2			19 - 60	1.8	1
		⊙ /MM	46 11 A1	Circlip Pliers for external circlips on shafts		10 - 25	1.3	1
		⊙ /MM	46 11 A2			19 - 60	1.8	1
00 19 57	050056		Precision Circlip Pliers Set, 4 parts					665
		⊙	48 11 J1	Precision Circlip Pliers for internal circlips in bore holes	straight tips	12 - 25	1.3	1
			48 11 J2			19 - 60	1.8	1
		⊙ /MM	49 11 A1	Precision Circlip Pliers for external circlips on shafts		10 - 25	1.3	1
			49 11 A2			19 - 60	1.8	1
00 19 57 V01	081555		Precision Circlip Pliers Set, 4 parts					871
		⊙	48 11 J2	Precision Circlip Pliers for internal circlips in bore holes	straight tips	19 - 60	1.3	1
		⊙ ∠90°	48 21 J21		bent tips	19 - 60	1.8	1
		⊙ /MM	49 11 A2	Precision Circlip Pliers for external circlips on shafts	straight tips	19 - 60	1.3	1
		⊙ ∠90° /MM	49 21 A21		bent tips	19 - 60	1.8	1
00 19 56 LE	035954		Tool Roll, empty, 4 compartments					171

Set of Circlip Pliers

Handy storage: eight-piece range in space-saving roll-up bag

- > Tool roll made of hard-wearing polyester fabric
- > With practical, adjustable quick release fastener
- > Dimensions, open (L x H): 610 x 240 mm

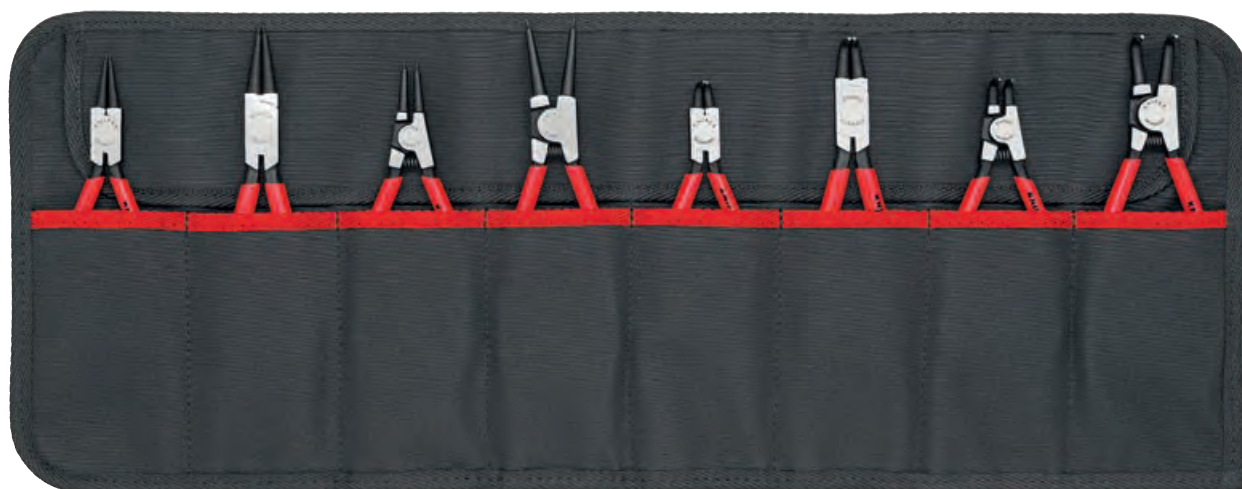

00 19 57 V01



00 19 58 V02

Article No.	EAN			Style	Capacity Ø mm	Tips Ø mm	Number	g
00 19 58 V01	081562		Circlip Pliers Set, 8 parts					1156
		⊙	44 11 J1	Circlip Pliers for internal circlips in bore holes	straight tips	12 - 25	1.3	1
		⊙	44 11 J2			19 - 60	1.8	1
		⊙ ∠90°	44 21 J11		angled tips	12 - 25	1.3	1
		⊙ ∠90°	44 21 J21			19 - 60	1.8	1
		⊙ M	46 11 A1	Circlip Pliers for external circlips on shafts	straight tips	10 - 25	1.3	1
		⊙ M	46 11 A2			19 - 60	1.8	1
		⊙ ∠90° M	46 21 A11		angled tips	10 - 25	1.3	1
		⊙ ∠90° M	46 21 A21			19 - 60	1.8	1
00 19 58 V02	081579		Precision Circlip Pliers Set, 8 parts					1357
		⊙	48 11 J1	Precision Circlip Pliers for internal circlips in bore holes	straight tips	12 - 25	1.3	1
		⊙	48 11 J2			19 - 60	1.8	1
		⊙ ∠90°	48 21 J11		angled tips	12 - 25	1.3	1
			48 21 J21			19 - 60	1.8	1
		⊙ M	49 11 A1	Precision Circlip Pliers for external circlips on shafts	straight tips	10 - 25	1.3	1
			49 11 A2			19 - 60	1.8	1
		⊙ ∠90° M	49 21 A11		angled tips	10 - 25	1.3	1
			49 21 A21			19 - 60	1.8	1
00 19 58 LE	081920		Tool Roll, empty, 8 compartments					281

Mini pliers sets

**Small pliers for big jobs:
mini pliers sets in practical
tool belt pouch**

- > Tool bag made from durable polyester fabric, with hook-and-loop fastener and belt clip
- > Dimensions (W x H x D): 75 x 180 x 55 mm



00 20 72 V01



00 20 72 V02



00 20 72 V04



00 20 72 V06



00 19 72 V01

Article No.	EAN			Number	g
00 20 72 V01	4003773-070832		Mini pliers set in tool belt pouch, 2 parts		350
			86 03 150 Pliers Wrench	1	
			87 01 125 KNIPEX Cobra®, Hightech Water Pump Pliers	1	
00 20 72 V02	075851		Mini pliers set in tool belt pouch, 2 parts		390
			74 01 160 High Leverage Diagonal Cutter	1	
			87 01 150 KNIPEX Cobra®, Hightech Water Pump Pliers	1	
00 20 72 V04	078920		Mini pliers set in tool belt pouch, 2 parts		264
			86 03 125 Pliers Wrench	1	
			87 01 125 KNIPEX Cobra®, Hightech Water Pump Pliers	1	
00 20 72 V06	081937		Mini pliers set in tool belt pouch, 2 parts		355
			08 22 145 Needle-Nose Combination Pliers	1	
			87 01 150 KNIPEX Cobra®, Hightech Water Pump Pliers	1	
00 19 72 V01	070832		Cable tie cutting set, 2 parts		350
			86 03 150 S02 Pliers Wrench	1	
			79 02 125 S1 Precision Electronics Diagonal Cutter	1	
00 19 72 LE	070191		Belt pouch for two pliers up to 160 mm length, empty		65

Mini pliers set

Our unbeatable duo, even when you're on the move: handy-sized cutting, gripping and screwing tools

► For gripping, holding and cutting tasks, both large and small

- > KNIPEX Mini Cobra®: the high tech water pump pliers – adjustment directly on the workpiece at the press of a button; with fine adjustment for optimum adaptation to different workpiece sizes up to Ø 27 mm
- > Needle-nose combination pliers: ideal for working in hard-to-reach places thanks to the slender head shape with powerful, pointed jaws; with cutting edges for soft, medium hard and hard wire up to Ø 2 mm



KNIPEX Cobra®: with fine adjustment directly on the workpiece



Needle-Nose Combination Pliers: the convex gripping surface on one side makes this the ideal tool for gripping flat parts



00 20 72 V06

Article No.	EAN 4003773-				Number	g
00 20 72 V06	081937			Mini pliers set in tool belt pouch, 2 parts		355
			08 22 145	Needle-Nose Combination Pliers	1	
			87 01 150	KNIPEX Cobra®, Hightech Water Pump Pliers	1	
00 19 72 LE	070191			Belt pouch for two pliers up to 160 mm length, empty		65

Cable tie cutting set

Safety first: remove the cable tie without damaging the insulation

► For reliable removal of cable harnesses, e.g. in the aerospace industry

- > Pliers wrench with special laser shearing for a good hold: grip, compress or loosen the head of the cable tie, all without cutting it
- > Precision electronics diagonal cutter with rounded pliers head: for low-risk cutting of cable ties in confined spaces or when the cable tie head cannot be held; also suitable for cutting hard wires up to Ø 0.7 mm



The cable tie can be safely gripped and compressed with the laser-tooled jaws



All edges on the pliers head are specially rounded – unintentional damage to the insulation is avoided



00 19 72 V01

Article No.	EAN 4003773-				Number	g
00 19 72 V01	070832			Cable tie cutting set, 2 parts		350
			86 03 150 S02	Pliers Wrench	1	
			79 02 125 S1	Precision Electronics Diagonal Cutter	1	
00 19 72 LE	070191			Belt pouch for two pliers up to 160 mm length, empty		65

Case for Electronics Pliers

**Ideal for precision mechanical work:
precision tools in a practical bag**

> Dimensions, closed (W x H x D): 215 x 160 x 50 mm

00 20 16

7 parts, contains 6 electronics pliers and one pair of precision tweezers; case made of hard-wearing polyester fabric, pliers are held by elastic band, zippered



00 20 16

00 20 16 P

6 parts, contains 6 precision electronics pliers; case made of hard-wearing polyester fabric, pliers are held by elastic band, zippered



00 20 16 P

00 20 16 P ESD

6 parts, contains 6 ESD precision electronics pliers, electrically discharging version; case made of hard-wearing polyester fabric, pliers are held by elastic band, zippered



00 20 16 P ESD

00 20 17

6 parts, contains 6 ESD electronics pliers, electrically discharging version; case made of hard-wearing polyester fabric, pliers are held by elastic band, zippered



00 20 17

00 20 18

8 parts, contains 2 electronics pliers and 6 electronics screwdrivers; practical storage box, shock-resistant plastic, with foam insert



00 20 18

00 20 18 ESD

8 parts, contains 2 electronics pliers and 6 electronics screwdrivers, ESD electrically discharging version; practical storage box, shock-resistant plastic, with foam insert



00 20 18 ESD

Article No.	EAN 4003773-	Contents	g
00 20 16	022619	35 12 115 / 35 22 115 / 35 32 115 / 64 32 120 / 77 02 115 / 77 42 115 / 92 34 36	720
00 20 16 P	063223	34 12 130 / 34 22 130 / 34 32 130 / 79 02 120 / 79 02 120 / 79 02 125 / 79 42 125	575
00 20 16 P ESD	063230	34 12 130 ESD / 34 22 130 ESD / 34 32 130 ESD / 79 02 120 ESD / 79 02 125 ESD / 79 42 125 ESD	585
00 20 17	031222	35 12 115 ESD / 35 22 115 ESD / 35 42 115 ESD / 64 32 120 ESD / 77 02 115 ESD / 77 32 115 ESD	695
00 20 18	033073	35 22 115 / 77 02 115 / screw drivers 0,4 x 2,5 / 0,5 x 3,0 / 0,6 x 3,5 / 0,8 x 4,0 / PH0 / PH1	460
00 20 18 ESD	051848	35 22 115 ESD / 77 02 115 ESD / screw drivers 0,4 x 2,5 / 0,5 x 3,0 / 0,6 x 3,5 / 0,8 x 4,0 / PH0 / PH1	465

Pliers Sets

Ideally stored and versatile: plier sets in matching foam insert for workbench and workshop trolley

- > In a foam tray for workbenches and tool trolleys
- > Clearly organised storage of tools
- > Precisely-sized recesses for holding the pliers
- > Foam tray dimensions (W x H x D): 335 x 165 x 33 mm
- > Material: two colour, closed pore foam



00 20 01 V02 Pliers Set "SRZ"



00 20 01 V09 Pliers Set "SRZ II"

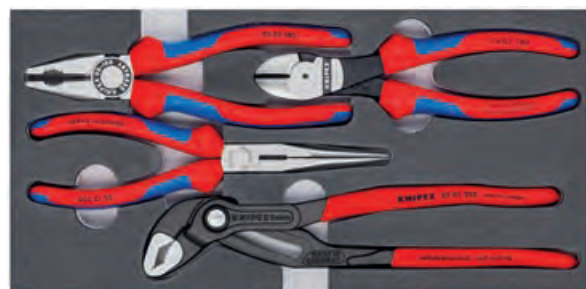

00 20 01 V15 Pliers Set "Basic"



00 20 01 V16 Pliers Set "Automotive"



00 20 01 V17 Pliers Set "Basic Chrome"

Article No.	EAN				Number	g
00 20 01 V02	4003773-069652			Pliers Set "SRZ", six precision circlip pliers in a foam tray		915
		☉	48 11 J1	Precision Circlip Pliers for internal circlips in bore holes	1	
			48 11 J2		1	
		☉ 90°	48 21 J21		1	
		☉ M	49 11 A1	Precision Circlip Pliers for external circlips on shafts	1	
			49 11 A2		1	
		☉ M 90°	49 21 A21		1	
00 20 01 V09	073291			Pliers Set "SRZ II", four precision circlip pliers in a foam tray		820
		☉	48 11 J2	Precision Circlip Pliers for internal circlips in bore holes	1	
		☉ 90°	48 21 J21		1	
		☉ M	49 11 A2	Precision Circlip Pliers for external circlips on shafts	1	
		☉ M 90°	49 21 A21		1	
00 20 01 V15	081586			Pliers Set "Basic", four pliers in a foam tray		1121
		☉	03 02 180	Combination Pliers	1	
		☉	26 12 200	Snipe Nose Side Cutting Pliers (Stork Beak Pliers)	1	
		☉	74 02 180	High Leverage Diagonal Cutter	1	
		☉	87 01 250	KNIPEX Cobra®, Hightech Water Pump Pliers	1	
00 20 01 V16	081593			Pliers Set "Automotive", four pliers in a foam tray		850
		☉	08 21 145	Needle-Nose Combination Pliers	1	
		☉	74 01 180	High Leverage Diagonal Cutter	1	
		☉	28 71 280	Long Reach Needle Nose Pliers with transverse profiles	1	
		☉ 45°	28 81 280		1	
00 20 01 V17	081944			Pliers Set "Basic Chrom", four pliers in a foam tray		1140
		☉	03 05 180	Combination Pliers	1	
		☉	26 15 200	Snipe Nose Side Cutting Pliers (Stork Beak Pliers)	1	
		☉	74 05 180	High Leverage Diagonal Cutter	1	
		☉	87 05 250	KNIPEX Cobra®, Hightech Water Pump Pliers	1	

Precision Circlip Pliers Set

- > Attractive sales packaging with Euro standard perforation
- > Contains common Precision Circlip Pliers for highest requirements
- > Sturdy plastic packaging, also suitable for storage of the pliers



00 20 03 SB



00 20 04 SB

Article No.	EAN 4003773-			Style	Capacity Ø mm	Tips Ø mm	Quantity	g	
00 20 03 SB	050100		Precision Circlip Pliers Set					685	
			48 11 J1	Precision Circlip Pliers, for internal circlips in bore holes	straight tips	12 - 25	1,3		1
			48 11 J2			19 - 60	1,8		1
			49 11 A1	Precision Circlip Pliers, for external circlips on shafts	straight tips	10 - 25	1,3		1
			49 11 A2			19 - 60	1,8		1
00 20 04 SB	062417		Precision Circlip Pliers Set						1275
			48 11 J1	Precision Circlip Pliers, for internal circlips in bore holes	straight tips	12 - 25	1,3	1	
			48 11 J2			19 - 60	1,8	1	
			49 11 A1	Precision Circlip Pliers, for external circlips on shafts	straight tips	10 - 25	1,3	1	
			49 11 A2			19 - 60	1,8	1	
			48 21 J11	Precision Circlip Pliers, for internal circlips in bore holes	angled tips	12 - 25	1,3	1	
			48 21 J21			19 - 60	1,8	1	
			49 21 A11	Precision Circlip Pliers, for external circlips on shafts	angled tips	12 - 25	1,3	1	
			49 21 A21			19 - 60	1,8	1	

Set of Circlip Pliers

- > Attractive sales packaging with Euro standard perforation
- > Contains common Circlip Pliers for internal and external circlips
- > Sturdy plastic packaging, also suitable for storage of the pliers



00 20 03 V02



00 20 04 V01

Article No.	EAN 4003773-			Style	Capacity Ø mm	Tips Ø mm	Quantity	g	
00 20 03 V02	077640		Set of Circlip Pliers					450	
			44 11 J1	Circlip Pliers, for internal circlips in bore holes	straight tips	12 - 25	1,3		1
			44 11 J2			19 - 60	1,8		1
			46 11 A1	Circlip Pliers, for external circlips on shafts	straight tips	10 - 25	1,3		1
			46 11 A2			19 - 60	1,8	1	
00 20 04 V01	077633		Set of Circlip Pliers					890	
			44 11 J1	Circlip Pliers, for internal circlips in bore holes	straight tips	12 - 25	1,3		1
			44 11 J2			19 - 60	1,8		1
			46 11 A1	Circlip Pliers, for external circlips on shafts	straight tips	10 - 25	1,3		1
			46 11 A2			19 - 60	1,8		1
			44 21 J11	Circlip Pliers, for internal circlips in bore holes	angled tips	12 - 25	1,3		1
			44 21 J21			19 - 60	1,8		1
			46 21 A11	Circlip Pliers, for external circlips on shafts	angled tips	10 - 25	1,3		1
			46 21 A21			19 - 60	1,8	1	

Extension sets Electro

Extension set "Electro 1"

Amplify your tool range with
10 additional brand tools

KNIPEX

- > KNIPEX TwinKey®
- > VDE High Leverage Diagonal Cutter 200 mm
- > VDE Snipe Nose Side Cutting Pliers 160 mm, bent
- > VDE Cable shears 165 mm
- > KNIPEX Cobra® 180 mm
- > Universal Stripping Tool
- > VDE screwdrivers PlusMinus PZ/S #1
- > VDE screwdrivers PlusMinus PZ/S #2

Stabila

- > Pocket Electric

Others

- > Wooden folding rule 2 m



00 20 90 V01

Extension set "Electro 2"

Amplify your tool range with
13 additional brand tools

KNIPEX

- > KNIPEX TwinKey®
- > VDE High Leverage Diagonal Cutter 200 mm
- > VDE Snipe Nose Side Cutting Pliers 160 mm, bent
- > VDE Cable shears 165 mm
- > KNIPEX Cobra® 180 mm
- > KNIPEX ErgoStrip® – Universal Stripping Tool
- > VDE Electronic Super Knips®
- > Automatic Insulation Stripper
- > Crimping Pliers for wire ferrules
- > VDE screwdrivers PlusMinus PZ/S #1
- > VDE screwdrivers PlusMinus PZ/S #2

Stabila

- > Pocket Electric

Others

- > Wooden folding rule 2 m



00 20 90 V02

Artikel-Nr.	EAN	⚖
00 20 90 V01	4003773-084693	g
		1415

Artikel-Nr.	EAN	⚖
00 20 90 V02	4003773-084709	g
		1915

Tool Kits

- > Tools in a plastic deep-drawn tray with transparent lid
- > Attractive sales packaging with Euro standard perforation
- > Dimensions (W x H x D): 170 x 370 x 40 mm



00 20 09 V01 Bestseller-Set

Pliers with polished heads; handles with non-slip plastic coating and with two-colour multi-component grips

Article No.	EAN					Quantity	Nominal size	g
00 20 09 V01	4003773-073994		Bestseller-Set					950
			03 02 180	Combination Pliers	Knipex	1	180 mm	
			70 02 160	Diagonal Cutter		1	160 mm	
			87 01 250	KNIPEX Cobra®, Hightech Water Pump Pliers		1	250 mm	



00 20 09 V02 Cobra® Set

Pliers grey afromentized; handles with non-slip plastic coating

Article No.	EAN					Quantity	Nominal size	g
00 20 09 V02	4003773-074793		Cobra® Set					1220
			87 01 180	KNIPEX Cobra®, Hightech Water Pump Pliers	Knipex	1	180 mm	
			87 01 250			1	250 mm	
			87 01 300			1	300 mm	



00 20 09 V03 Alligator® Set

Pliers with polished heads; handles with non-slip plastic coating

Article No.	EAN					Quantity	Nominal size	g
00 20 09 V03	4003773-074809		Alligator® Set					1195
			88 01 180	KNIPEX Alligator®, Water Pump Pliers	Knipex	1	180 mm	
			88 01 250			1	250 mm	
			88 01 300			1	300 mm	



00 20 10 Power Set

Pliers with polished heads and plastic coated handles

Article No.	EAN					Quantity	Nominal size	g
00 20 10	4003773-010388		Power Set					990
			02 01 180	High Leverage Combination Pliers	Knipex	1	180 mm	
			74 01 160	High Leverage Diagonal Cutter		1	160 mm	
			87 01 250	KNIPEX Cobra®, Hightech Water Pump Pliers		1	250 mm	



00 20 11 Assembly Set
Pliers with two-colour multi-component grips

Article No.	EAN				Quantity	Nominal size	g
00 20 11	4003773-012405		Assembly Set				810
			03 02 180	Combination Pliers	1	180 mm	
			26 12 200	Snipe Nose Side Cutting Pliers (Stork Beak Pliers)	1	200 mm	
			70 02 160	Diagonal Cutter	1	160 mm	



00 20 11 V01 Assembly Set
Pliers chrome-plated, with two-colour multi-component grips

Article No.	EAN				Quantity	Nominal size	g
00 20 11 V01	4003773-064091		Assembly Set				874
			03 05 180	Combination Pliers	1	180 mm	
			26 15 200	Snipe Nose Side Cutting Pliers (Stork Beak Pliers)	1	200 mm	
			74 05 180	High Leverage Diagonal Cutter	1	160 mm	



00 20 12 Electro Set
Pliers VDE-tested in conformance with DIN EN/IEC 60900 1000V, pliers chrome-plated, handles with multi-component grips

Article No.	EAN				Quantity	Nominal size	g
00 20 12	4003773-012412		Electro Set				960
			03 06 180	Combination Pliers	1	180 mm	
			26 16 200	Snipe Nose Side Cutting Pliers (Stork Beak Pliers)	1	200 mm	
			70 06 160	Diagonal Cutter	1	160 mm	



00 20 13 VDE Tool Set
Tools VDE-tested in conformance to DIN EN/IEC 60900 1000V, pliers chrome-plated, handles with multi-component covers; with 3 WERA screwdrivers

Article No.	EAN				Quantity	Nominal size	g
00 20 13	4003773-043287		VDE Tool Set				850
			26 16 200	Snipe Nose Side Cutting Pliers (Stork Beak Pliers)	1	200 mm	
			70 06 160	Diagonal Cutter	1	160 mm	
			006110	Screwdrivers for slotted screws, 160i	1	0,6 x 3,5 x 100 mm	
			006120	Screwdrivers for slotted screws, 160i	1	1,0 x 5,5 x 125 mm	
			006154	Screwdrivers for cross recessed Phillips® screws, 162i PH	1	PH2 x 100 mm	

Tool Kits

- > Tools in a plastic deep-drawn tray with transparent lid
- > Attractive sales packaging with Euro standard perforation
- > Dimensions (W x H x D): 170 x 370 x 40 mm



00 20 12 V01 VDE Screwdriver Set

Tip burnished; insulating multi-component handle, VDE-tested

Article No.	EAN				Quantity	Nominal size	g
00 20 12 V01	4003773-075523			VDE Screwdriver Set			610
			98 20 30	Screwdrivers for slotted screws	Knipex	1	3,0 mm
		⚠ 1000 V	98 20 40			1	4,0 mm
			98 20 55			1	5,5 x 125 mm
			98 20 65			1	6,5 mm
			98 24 01	Screwdriver for cross recessed screws, Phillips®	Knipex	1	PH1
		⚠ 1000 V	98 24 02			1	PH2



00 20 12 V02 VDE Screwdriver Set Slotted / Phillips®

Tip burnished; insulating multi-component handle, VDE-tested

Article No.	EAN				Quantity	Nominal size	g
00 20 12 V02	4003773-082538			VDE Screwdriver Set Slotted / Phillips®			550
			98 20 30	Screwdrivers for slotted screws	Knipex	1	3,0 mm
		⚠ 1000 V	98 20 40 SL			1	4,0 mm
			98 20 55 SL	Screwdriver (Slim) for slotted screws	Knipex	1	5,5 mm
			98 20 65 SL			1	6,5 mm
			98 24 01 SL	Screwdriver (Slim) for cross-recessed screws, Phillips®	Knipex	1	PH1
		⚠ 1000 V	98 24 02 SL			1	PH2



00 20 12 V03 VDE Screwdriver Set Phillips® / Pozidriv®

Tip burnished; insulating multi-component handle, VDE-tested

Article No.	EAN				Quantity	Nominal size	g
00 20 12 V03	4003773-082545			VDE Screwdriver Set Phillips® / Pozidriv®			500
			98 24 00	Screwdriver for cross recessed screws, Phillips®	Knipex	1	PH0
		⚠ 1000 V	98 24 01 SL			1	PH1
			98 24 02 SL	Screwdriver (Slim) for cross-recessed screws, Phillips®	Knipex	1	PH2
			98 25 00			1	PZ0
			98 25 01 SL	Screwdriver (Slim) for cross-recessed screws, Pozidriv®	Knipex	1	PZ1
		⚠ 1000 V	98 25 02 SL			1	PZ2



00 20 12 V04 VDE Screwdriver Set Slotted / Phillips® / Pozidriv®

Tip burnished; insulating multi-component handle, VDE-tested

Article No.	EAN				Quantity	Nominal size	g
00 20 12 V04	4003773-082552			VDE Screwdriver Set Slotted / Phillips® / Pozidriv®			509
		⚠ 1000 V	98 20 25	Screwdrivers for slotted screws	1	2,5 mm	
		⚠ 1000 V	98 20 40 SL	Screwdriver (Slim) for slotted screws	1	4,0 mm	
		⚠ 1000 V	98 24 01 SL	Screwdriver (Slim) for cross-recessed screws, Phillips®	1	PH1	
		⚠ 1000 V	98 24 02 SL	Screwdriver (Slim) for cross-recessed screws, Phillips®	1	PH2	
		⚠ 1000 V	98 25 01 SL	Screwdriver (Slim) for cross-recessed screws, Pozidriv®	1	PZ1	
		⚠ 1000 V	98 25 02 SL	Screwdriver (Slim) for cross-recessed screws, Pozidriv®	1	PZ2	



00 20 12 V05 VDE Screwdriver Set PlusMinus / Slotted

Tip burnished; insulating multi-component handle, VDE-tested

Article No.	EAN				Quantity	Nominal size	g
00 20 12 V05	4003773-082569			VDE Screwdriver Set PlusMinus / Slotted			510
		⚠ 1000 V	98 20 25	Screwdrivers for slotted screws	1	2,5 mm	
		⚠ 1000 V	98 20 40 SL	Screwdriver (Slim) for slotted screws	1	4,0 mm	
		⚠ 1000 V	98 24 01 SLS	(Slim) PlusMinus screwdriver, Phillips®	1	PH/S 1	
		⚠ 1000 V	98 24 02 SLS	(Slim) PlusMinus screwdriver, Phillips®	1	PH/S 2	
		⚠ 1000 V	98 25 01 SLS	(Slim) PlusMinus screwdriver, Pozidriv®	1	PZ/S 1	
		⚠ 1000 V	98 25 02 SLS	(Slim) PlusMinus screwdriver, Pozidriv®	1	PZ/S 2	

Pliers Sets

00 31 20 V01

> With KNIPEX Cobra®
87 01 180 and 87 01 250

00 31 20 V02

> With KNIPEX Alligator®
88 01 180 and 88 01 250

00 31 20 V03

> With Pliers Wrench 86 03 180
and KNIPEX Cobra® 87 01 250



00 31 20 V01



00 31 20 V02



00 31 20 V03

Article No.	EAN				Quantity	g
00 31 20 V01	4003773-077251			Set of pliers		555
	022015	▧	87 01 180	KNIPEX Cobra® Hightech Water Pump Pliers	1	170
	022022	▧	87 01 250	KNIPEX Cobra® Hightech Water Pump Pliers	1	335
00 31 20 V02	077268			Set of pliers		535
	035480	▧	88 01 180	KNIPEX Alligator® Water Pump Pliers	1	180
	022992	▧	88 01 250	KNIPEX Alligator® Water Pump Pliers	1	331
00 31 20 V03	078104			Set of pliers		620
	035466	▧	86 03 180	Pliers Wrench Pliers and a wrench in a single tool	1	230
	022022	▧	87 01 250	KNIPEX Cobra® Hightech Water Pump Pliers	1	335

Tool Box "RED" Electro Set 1

Versatile use: the small four-piece VDE tool range in a handy case

- > High quality, versatile, shock-resistant plastic case
- > Foam insert with honeycomb structure for variable equipment
- > Dimensions, exterior (W x H x D): 340 x 56 x 275 mm

00 20 15

Pliers VDE-tested according to DIN EN/IEC 60900 1000V

00 21 15 LE

Box without tools

00 20 15



Article No.	EAN				Number	g
00 20 15	4003773-024804			Tool Box "RED" Electro-Set 1, 4 parts		1430
		⚡ 1000 V	🔧	03 06 180	Combination Pliers	1
		⚡ 1000 V	🔧	11 06 160	Insulation Stripper	1
		⚡ 1000 V	🔧	26 16 200	Snipe Nose Side Cutting Pliers (Stork Beak Pliers)	1
		⚡ 1000 V	🔧	70 06 160	Diagonal Cutter	1
00 21 15 LE	045175			Tool Box "RED", empty		530

Tool Box "RED" Electro Set 2

All you need, safely stored: seven-piece VDE tool set for electrical installation

- > High quality, versatile, shock-resistant plastic case
- > Foam insert with honeycomb structure for variable equipment
- > Dimensions, exterior (W x H x D): 340 x 56 x 275 mm

00 21 15

All pliers and screwdrivers except Water Pump Pliers
VDE-tested according to DIN EN/IEC 60900

00 21 15 LE

Box without tools

00 21 15



Article No.	EAN				Number	Nominal size	g
00 21 15	4003773-042853			Tool Box "RED" Electro-Set 2, 7 parts			1520
		⚡ 1000 V	🔧	03 06 180	Combination Pliers	180 mm	KNIPEX
		⚡ 1000 V	🔧	26 16 200	Snipe Nose Side Cutting Pliers (Stork Beak Pliers)	200 mm	
		⚡ 1000 V	🔧	70 06 160	Diagonal Cutter	160 mm	
		🔧	88 03 180	KNIPEX Alligator®, Water Pump Pliers	180 mm		
		⚡ 1000 V	🔧		Screwdrivers for slotted screws, 160i	0.4 x 2.5 x 80 mm	Wera
		⚡ 1000 V	🔧		Screwdrivers for cross recessed Phillips® screws, 162i PH	0.8 x 4.0 x 100 mm	
		⚡ 1000 V	🔧		Screwdrivers for cross recessed Phillips® screws, 162i PH	PH1 x 80 mm	1
00 21 15 LE	045175			Tool Box "RED", empty			530

Tool Box "SRZ" Precision Circlip Pliers

Well fixed, safely transported:
Extensive range in handy case

- > High-quality, impact-resistant plastic case
- > Contains common Precision Circlip Pliers for highest requirements
- > Precisely-sized recesses for holding the pliers
- > Clearly organised storage of tools
- > Dimensions, exterior (W x H x D): 260 x 80 x 210 mm



Article No.	EAN			Style	Capacity Ø mm	Tips Ø mm	Number	⚖ g
00 21 25	4003773-050131		Tool Box "SRZ", Precision Circlip Pliers					1635
		○	48 11 J1 48 11 J2	straight tips	12 - 25	1.3	1	
			Precision Circlip Pliers for internal circlips in bore holes		19 - 60	1.8	1	
		○ MM	49 11 A1 49 11 A2		10 - 25	1.3	1	
			Precision Circlip Pliers for external circlips on shafts		19 - 60	1.8	1	
		○ ∠90°	48 21 J11 48 21 J21	angled tips	12 - 25	1.3	1	
			Precision Circlip Pliers for external circlips on shafts		19 - 60	1.8	1	
		○ MM ∠90°	49 21 A11 49 21 A21		10 - 25	1.3	1	
			Precision Circlip Pliers for external circlips on shafts		19 - 60	1.8	1	



“Basic”

Solid basis for tool equipment



Tool Case "Basic"

A classic: everything well sorted

- ▶ Two metal flip locks and a three-digit combination lock for secure locking of the cover
- ▶ Label field with two stickers for individual labelling
- ▶ Max. payload: 15 kg
- ▶ Volume: 27 litres

- > Strong, ergonomic handle
- > Rugged design made of ABS material, black
- > Circumferential aluminium frame
- > Metal hinges
- > Document compartment in the cover
- > Two removable tool boards made from dirt-repellent PP twin-wall sheets with 20 tool pockets
- > Base tray, can be fixed by press button, height 50 mm, can be subdivided by flexible inserts; cover plate with 13 large compartments
- > With a total of 41 inserting options



Tool boards made from dirt-repellent PP twin-wall sheets



00 21 05 LE
Case supplied without tools

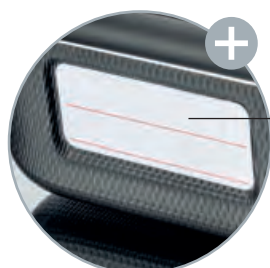

Label field with two stickers for individual labelling



Two metal flip locks



Base tray with separable inserts



Article No.	EAN	Dimension exterior (interior) width mm	Dimension exterior (interior) height mm	Dimension exterior (interior) depth mm	g
00 21 05 LE	4003773-056904	465 (440)	410 (350)	200 (180)	4000



“BIG Basic Move”
Mobile companion when travelling

Tool Case "BIG Basic Move"

Classic all-rounder with trolley function for working on the move

- ▶ Telescopic handle set in the base as well as two external, smooth-running skater wheels
- ▶ Two metal flip locks and a three-digit combination lock for secure locking of the cover
- ▶ Label field with two stickers for individual labelling
- ▶ Max. payload: 20 kg
- ▶ Volume: 33 litres

- > Strong, ergonomic handle
- > Rugged design made of ABS material, black
- > Circumferential aluminium frame
- > Metal hinges
- > Document compartment in the cover
- > Two removable tool boards made of dirt-repellent PP twin-wall sheets with 31 tool pockets
 - First tool board with ten tool pockets and an elastic strap on the cover side and eleven narrow and one large tool pocket on the base side
 - Second tool board with ten narrow tool pockets and an elastic strap on the base side and document compartment on the cover side
- > Base tray, can be fixed by press button, height 70 mm, can be subdivided by flexible inserts; cover plate with 14 large compartments
- > With a total of 54 inserting options



Tool boards made from dirt-repellent PP twin-wall sheets



Base tray with separable inserts



Extendable telescopic handle



Smooth-running skater wheels

00 21 06 LE
Case supplied without tools



Article No.	EAN	Dimension exterior (interior) width mm	Dimension exterior (interior) height mm	Dimension exterior (interior) depth mm	g
00 21 06 LE	4003773-057512	515 (480)	430 (350)	280 (200)	6200

Tool Case "BIG Basic Move" Electro

The basic mobile tool kit for electricians

- ▶ Equipped with six KNIPEX tools, a total of 24 brand tools, partly VDE-tested according to DIN EN 60900

▶ For further benefits of the case, see page 289



00 21 06 HL S

Content overview

03 06 180 KNIPEX		98 52 KNIPEX		Rennsteig		Ruthe	
25 06 160 KNIPEX		8 x Wera		Stabila		Ruthe	
11 06 160 KNIPEX		Wera		Picard		maurerfreund	
70 06 160 KNIPEX		Rennsteig		Picard		Haunstätter	
16 20 165 KNIPEX							

Article No.	EAN					Number	Nominal size	g
00 21 06 HLS	4003773-052296		Tool Case "BIG Basic Move" Electro, 24 parts					9610
			03 06 180	Combination Pliers	KNIPEX	1	180 mm	
			25 06 160	Snipe Nose Side Cutting Pliers, Radio Pliers		1	160 mm	
			11 06 160	Insulation Stripper		1	160 mm	
			70 06 160	Diagonal Cutter		1	160 mm	
			16 20 165	Dismantling Tool		1	165 mm	
			98 52	Cable Knife		1	185 mm	
				Screwdrivers for slotted screws, 1160i	Wera	1	0.4 x 2.5 x 80 mm	
						1	0.6 x 3.5 x 100 mm	
						1	1.0 x 5.5 x 125 mm	
						1	1.2 x 6.5 x 150 mm	
						1	0.5 x 3.0 x 70 mm	
				Screwdrivers for cross recessed Phillips® screws, 1162i	Rennsteig	1	PH1 x 80 mm	
				Screwdrivers for cross recessed Pozidriv® screws, 1165i		1	PH2 x 100 mm	
				Screwdrivers for cross recessed Pozidriv® screws, 1165i		1	PZ1 x 80 mm	
				Voltage detector, single-pole, 247		1	PZ2 x 100 mm	
				Mason's Chisels	Rennsteig	1	250 mm	
				Electrician's Chisel		1	250 x 10 mm	
				Carpenter's pencil	Stabila	1		
				Plaster bowl	Picard	1	127 x 94	
				Flat brush		1	40 mm	
				Locksmith's hammer	Ruthe	1	300 g	
				Sledge hammer		1	1000 g	
				Painter's spatula, wood, high quality	maurerfreund	1	40 mm	
				PUK® Junior Hacksaw	Haunstätter	1	150 x 240 mm	
00 21 06 LE	057512		Tool Case "BIG Basic Move", empty					6200

Tool Case „BIG Basic Move“ Electro Plus

Premium equipment for professional electricians

► Equipped with 26 KNIPEX tools, a total of 68 brand tools, partly VDE-tested according to DIN EN 60900

> For further benefits of the case, see page 289



00 21 06

Article No.	EAN				Number	Nominal size	g
00 21 06	4003773-086260		Tool Case "BIG Basic Move" Electro Plus, 68 parts				10600
			00 11 01	KNIPEX TwinKey®, Control Cabinet Key	KNIPEX	1	
			12 52 195	KNIPEX PreciStrip16		1	195 mm
		MM	16 95 01 SB	KNIPEX ErgoStrip®, Universal Stripping Tool		1	135 mm
		⚠ 1000 V ⚡ ⚙ ⚙	08 26 145	Needle-Nose Combination Pliers		1	145 mm
		⚠ 1000 V ⚡ ⚙ ⚙	13 86 200	Pliers for Electrical Installation		1	200 mm
		⊖ ⚡ ⚙ ⚙	26 26 200	Snipe Nose Side Cutting Pliers		1	200 mm
		⚠ 1000 V ⚡ ⚙ ⚙	70 06 160	Diagonal Cutter		1	160 mm
		⚠ 1000 V ⚡ ⚙ ⚙	74 06 200	High Leverage Diagonal Cutter		1	200 mm
		⚠ 1000 V ⚡ ⚙ ⚙	78 06 125	Electronic Super Knips® VDE		1	125 mm
		⚡ ⚙	87 01 180	KNIPEX Cobra®, Hightech Water Pump Pliers		1	180 mm
		⚡ MM	97 53 18	KNIPEX Twistor16® Self-Adjusting Crimping Pliers		1	478 mm
		⚠ 1000 V ⚡ ⚙ ⚙	98 20 25	Screwdrivers for slotted screws		1	2,5 mm
			98 20 35 SL			1	0,6 x 3,5 x 100 mm
		⚠ 1000 V ⚡ ⚙ ⚙	98 20 40 SL	Screwdriver (Slim) for slotted screws		1	0,8 x 4 x 100 mm
			98 20 55 SL			1	1,0 x 5,5 x 125 mm
			98 24 01 SL			1	PH 1 x 80
		⚠ 1000 V ⚡ ⚙ ⚙	98 24 02 SL	Screwdriver (Slim) for cross-recessed screws Phillips®		1	PH 2 x 100
			98 25 01 SL			1	PZ 1 x 80
			98 25 02 SL			1	PZ 2 x 100
		⚠ 1000 V ⚡ ⚙ ⚙	98 25 01 SLS	Screwdriver (Slim) PlusMinus Pozidriv®		1	187 mm
			98 25 02 SLS			1	212 mm
			98 26 10			1	160 mm TX 10
			98 26 15			1	185 mm TX 15
		⚠ 1000 V ⚡ ⚙ ⚙	98 26 20	Screwdriver for Torx® screws		1	185 mm TX 20
			98 26 25			1	185 mm TX 25
			98 26 30			1	210 mm TX 30
				Folding ruler Stabila series 400	Stabila		185 mm
				Pocket Electric mini spirit level		1	430 mm
				Spirit level type 70 Electric			
				Locksmith's hammer, 300 g	Picard	1	290 mm
				Electrician's Chisel	Rennsteig	1	250 mm
				8100 SA 8 Zyklop set of metal ratchets, 28 parts	Wera		
				Set of hex key wrenches		1	1,5 - 10 mm
00 21 06 LE	057512		Tool Case "BIG Basic Move", empty				6200

Tool Case "BIG Basic Move" Mechanics

All-round equipment for professional mechanics

► Equipped with 11 KNIPEX tools, a total of 79 brand tools, partly VDE-tested according to DIN EN 60900

> For further benefits of the case, see page 289



00 21 06 M

Article No.	EAN				Number	Nominal size	⚖ g	
00 21 06 M	4003773-086222		Tool Case "BIG Basic Move" Mechanics, 79 parts				12800	
			00 11 01	KNIPEX TwinKey®, Control Cabinet Key	KNIPEX	1		
		🔪	70 02 160	Diagonal Cutter		1	160 mm	
		🔪	74 02 200	High Leverage Diagonal Cutter		1	200 mm	
		🔪	71 31 200	KNIPEX CoBolt® Compact Bolt Cutters		1	200 mm	
		🔪	26 12 200	Snipe Nose Side Cutting Pliers		1	200 mm	
		🔪 40°	26 22 200	Snipe Nose Side Cutting Pliers		1	200 mm	
		🔪	78 61 140	Electronic Super Knips® XL		1	140 mm	
		🔪	16 95 01 SB	KNIPEX ErgoStrip®, Universal Stripping Tool		1	135 mm	
			16 20 50 SB	Folding Knife for Electricians		1	120 mm	
		🔪	86 01 250	Pliers Wrench		1	250 mm	
		🔪	87 01 250	KNIPEX Cobra®, Hightech Water Pump Pliers		1	250 mm	
		⊕		350 PH Screwdriver for Phillips screws		Wera	1	PH1 x 80 mm
		⊕		917 SPH Screwdriver for Phillips screws			1	PH2 x 100 mm
		⊕		350 PH Screwdriver for Phillips screws			1	PH3 x 150 mm
		⊕		355 PZ Screwdriver for Phillips screws	1		PZ1 x 80 mm	
		⊕		355 PZ Screwdriver for Phillips screws	1		PZ2 x 100 mm	
		⊕		355 PZ Screwdriver for Phillips screws	1		PZ3 x 150 mm	
		⊖		335 Screwdriver for slotted screws	1		3,5 x 100 mm	
		⊖		335 Screwdriver for slotted screws	1		4,0 x 100 mm	
		⊖		932 A Screwdriver for slotted screws	1		5,5 x 100 mm	
		⊕ ⊖		932 A Screwdriver for slotted screws	1		7,0 x 125 mm	
		⊕ ⊖		932 A Screwdriver for slotted screws	1		7,0 x 125 mm	
		⊕		367 Screwdriver for TORX® screws	1		TX 10x80	
		⊕		367 Screwdriver for TORX® screws	1		TX 15x80	
		⊕		367 Screwdriver for TORX® screws	1		TX 20 x 100	
		⊕		367 Screwdriver for TORX® screws	1	TX 25 x 100		
		⊕		367 Screwdriver for TORX® screws	1	TX 30 x 115		
		⊕		2050 Screwdriver for Phillips screws	1	PH0 x 60 mm		
		⊕		2050 Screwdriver for Phillips screws	1	PH00 x 60 mm		
		⊖		2035 Screwdriver for slotted screws	1	1,5 x 60 mm		
		⊖		2035 Screwdriver for slotted screws	1	2,5 x 80 mm		
				Locksmith's hammer	Picard	1	300 g	
				8100 SA 8 Zyklus set of metal ratchets, 28 parts	Wera	1	1/4"	
				Set of hex key wrenches		1	1,5 - 10 mm	
				Wooden folding rule	KNIPEX	1	185 mm	
				Spirit level type 70 Electric	Stabila	1	430 mm	
				Combination wrench set	Heyco	1		
				Set of parallel pin punches	Rennsteig	1		
				Automatic centre punch		1	130 mm	
00 21 06 LE	057512		Tool Case "BIG Basic Move", empty				6200	

Tool Case "BIG Basic Move" Sanitary

The basic mobile tool kit for sanitary, heating and air-conditioning professionals

- ▶ Equipped with four KNIPEX tools, a total of 31 brand tools, partly VDE-tested according to DIN EN 60900

> For further benefits of the case, see page 289



00 21 06 HK S

Content overview

70 06 160 KNIPEX		2 x Wera		Heyco		Rennsteig	
86 03 250 KNIPEX		Ruthe		Haunstätter		Stabila	
88 01 250 KNIPEX		Picard		Heyco		Stabila	
88 01 300 KNIPEX		Picard		Picard		9 parts Wera	
3 x Wera		Nölle		Picard		Zenten	

Article No.	EAN					Number	Nominal size	g	
00 21 06 HKS	4003773-070825		Tool Case "BIG Basic Move" Sanitary, 31 parts						9800
			70 06 160	Diagonal Cutter	KNIPEX	1	160 mm		
			86 03 250	Pliers Wrench		1	250 mm		
			88 01 250	KNIPEX Alligator®, Water Pump Pliers		1	250 mm		
			88 01 300			1	300 mm		
				Screwdrivers for slotted screws, 1160i	Wera	1	0.6 x 3.5 x 100 mm		
						1	1.0 x 5.5 x 125 mm		
						1	1.2 x 6.5 x 150 mm		
				Screwdrivers for cross recessed Phillips® screws, 1162i		1	PH1 x 80 mm		
						1	PH2 x 100 mm		
				Set of hex key wrenches		9	1.5 - 10 mm		
				Locksmith's hammer	Ruthe	1	300 g		
				Flat brush	Picard	1	40 mm		
				Carpenter's pencil	Picard	1	24 cm		
				Plasterer's bowl	Nölle	1	125 x 90 mm		
				Professional utility knife, zinc die casting	Heyco	1	170 mm; 18 mm		
				Express key		1	17 x 19 mm; M 10		
				PUK® Junior Hacksaw	Haunstätter	1	150 x 240 mm		
				Steel wire brush, 5-row	Picard	1	280 mm		
				Painter's spatula		1	40 mm		
				Electrician's Chisel	Rennsteig	1	250 x 10 mm		
				Spirit level type 70	Stabila	1	30 cm		
				Wooden folding rule type 607N		1	2 m		
				Pipe cutter	Zenten	1	3 - 35 mm / 1/8 - 1 1/2"		
00 21 06 LE	057512		Tool Case "BIG Basic Move", empty						6200

"BIG Twin"

Everything at a glance



The design for the "BIG Twin" series

Can be opened on both sides,
generous storage space with
numerous tool pockets



Three-digit combination lock



Label field with two stickers
for individual labelling

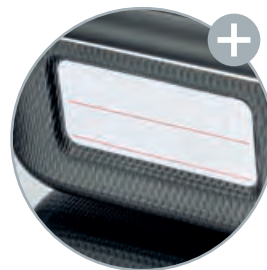

Large KNIPEX logo
on the cover



Two metal flip locks



Two deposit recesses
in the case cover



"BIG Twin Move" additionally with trolley function

Smooth-running
skater wheels



Extendable telescopic
handle

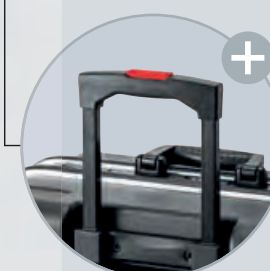

Tool Case "BIG Twin Move"

For quick access: everything at a glance, even on the move

- ▶ Telescopic handle set in the base as well as two external, smooth-running skater wheels
 - ▶ Free-standing in all opening positions thanks to snap-in cover holders with hinge mechanism on both sides, angle freely adjustable
 - ▶ Can be opened from one or both sides; bottom and lid can be opened independently of each other
 - ▶ Label field with two stickers for individual labelling
 - ▶ Max. payload: 30 kg
 - ▶ Volume: 44 litres
-
- > Rugged design made of ABS material, black
 - > Circumferential aluminium frame with securely mounted, sturdy centre wall that can be fitted on both sides, with versatile inserting options due to elasticated loops and twelve small pockets
 - > Metal hinges
 - > Three-digit combination lock for secure locking of the case
 - > Two metal flip locks each for fixing the cover and the base
 - > Removable document compartment and removable tool boards made from dirt-repellent PP twin-wall sheets with 13 tool pockets
 - > Base tray, can be fixed by press button, height 58 mm, can be subdivided by flexible inserts; cover plate with 13 large compartments
 - > With a total of 95 inserting options

Everything at hand thanks to intelligent layout

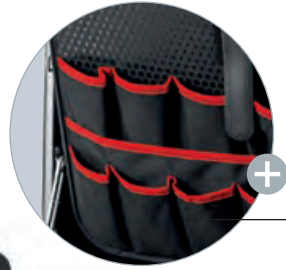

+

00 21 41 LE
Case supplied without tools

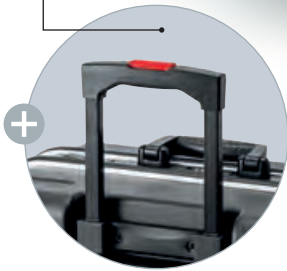

Extendable telescopic handle



Smooth-running skater wheels



Base tray with handy, robust aluminium dividing bars



"BIG Twin Move RED"
see page 300



Article No.	EAN	Dimension exterior (interior) width mm	Dimension exterior (interior) height mm	Dimension exterior (interior) depth mm	⚖ g
00 21 41 LE	4003773-071549	520 (490)	435 (370)	290 (110/100)	8600

Tool Case "BIG Twin Move" Electro

Everything under control, even when on the move: extensive range of tools for the professional electrician

► Equipped with 14 KNIPEX tools, a total of 63 brand tools, partly VDE-tested according to DIN EN 60900

> For further benefits of the case, see page 296



Content overview

00 11 01 KNIPEX		26 26 200 KNIPEX		97 53 04 KNIPEX		Wera	
08 26 145 KNIPEX		70 06 160 KNIPEX		98 52 KNIPEX		Picard	
12 42 195 KNIPEX		74 06 200 KNIPEX		2 x 98 2X XX SL KNIPEX		Rennsteig	
13 86 200 KNIPEX		86 03 180 KNIPEX		16 parts Wera		Stabila	
16 95 01 SB KNIPEX		87 01 180 KNIPEX		28 parts Wera		Stabila	

Article No.	EAN				Number	Nominal size	g
00 21 41	4003773-082118		Tool Case "BIG Twin Move" Electro, 63 parts				13250
			00 11 01	KNIPEX TwinKey®, Control Cabinet Key	KNIPEX	1	
		⚠ 1000 V	08 26 145	Needle-Nose Combination Pliers		1	145 mm
		⚠ 1000 V	12 42 195	KNIPEX MultiStrip 10, Automatic Insulation Stripper		1	195 mm
		⚠ 1000 V	13 86 200	Pliers for Electrical Installation		1	200 mm
		⚠ 1000 V	16 95 01 SB	KNIPEX ErgoStrip®, Universal Stripping Tool		1	135 mm
		⚠ 1000 V	26 26 200	Snipe Nose Side Cutting Pliers, (Stork Beak Pliers)		1	200 mm
		⚠ 1000 V	70 06 160	Diagonal Cutter		1	160 mm
		⚠ 1000 V	74 06 200	High Leverage Diagonal Cutter		1	200 mm
			86 03 180	Pliers Wrench		1	180 mm
			87 01 180	KNIPEX Cobra®, Hightech Water Pump Pliers		1	180 mm
			97 53 04	Self-Adjusting Crimping Pliers for wire end sleeves		1	180 mm
		⚠ 1000 V	98 52	Cable Knife		1	185 mm
		⚠ 1000 V	98 25 01 SL	Screwdrivers (Slim) for cross-recessed screws, Pozidriv®		1	PZ 1 x 80 mm
		⚠ 1000 V	98 20 35 SL	Screwdriver (Slim) for slotted screws		1	0,6 x 3.5x100mm
				Kraftform Kompakt VDE 16 extra slim 1, 16 parts	Wera	1	
				Zyklus set of metal ratchets, 8100 SA 8, 28 parts	1	1/4"	
				Joker open-end wrench	1	10 x 13 mm	
				Locksmith's hammer	Picard	1	300 g
				Electrician's Chisel	Rennsteig	1	250 x 10 mm
				Spirit level type 70 Electric	Stabila	1	430 mm
				Pocket Electric mini spirit level		1	68 mm
00 21 41 LE	071549		Tool Case "BIG Twin Move", empty				8600

Tool Case "BIG Twin"

**For quick access:
everything at a glance**

- ▶ Free-standing in all opening positions thanks to snap-in cover holders with hinge mechanism on both sides, angle freely adjustable
- ▶ Can be opened from one or both sides; bottom and lid can be opened independently of each other
- ▶ Label field with two stickers for individual labelling
- ▶ Max. payload: 25 kg
- ▶ Volume: 44 litres

- > Rugged design made of ABS material, black
- > Circumferential aluminium frame with securely mounted, sturdy centre wall that can be fitted on both sides, with versatile inserting options due to elasticated loops and twelve small pockets
- > Metal hinges
- > Three-digit combination lock for secure locking of the case
- > Two metal flip locks each for fixing the cover and the base
- > Removable document compartment and removable tool boards made from dirt-repellent PP twin-wall sheets with 13 tool pockets
- > Base tray, can be fixed by press button, height 58 mm, can be subdivided by flexible inserts; cover plate with 13 large compartments
- > With a total of 95 inserting options

Everything at hand thanks to intelligent layout



00 21 42 LE
Case supplied without tools



Base tray with handy, robust aluminium dividing bars



Article No.	EAN	Dimension exterior (interior) width mm	Dimension exterior (interior) height mm	Dimension exterior (interior) depth mm	⚖ g
00 21 42 LE	4003773-084211	520 (490)	435 (370)	250 (110/100)	7200

Tool Case "BIG Twin" Electro

Always at hand: extensive range of tools for the professional electrician

- ▶ Equipped with 14 KNIPEX tools, a total of 63 brand tools, partly VDE-tested according to DIN EN 60900

> For further benefits of the case, see page 298



00 21 42

Content overview

00 11 01 KNIPEX		26 26 200 KNIPEX		97 53 04 KNIPEX		Wera	
08 26 145 KNIPEX		70 06 160 KNIPEX		98 52 KNIPEX		Picard	
12 42 195 KNIPEX		74 06 200 KNIPEX		2 x 98 2X XX SL KNIPEX		Rennsteig	
13 86 200 KNIPEX		86 03 180 KNIPEX		16 parts Wera		Stabila	
16 95 01 SB KNIPEX		87 01 180 KNIPEX		28 parts Wera		Stabila	

Article No.	EAN				Number	Nominal size	g
00 21 42	4003773-081968		Tool Case "BIG Twin" Electro, 63 parts				11400
			00 11 01	KNIPEX TwinKey®, Control Cabinet Key	KNIPEX	1	
			08 26 145	Needle-Nose Combination Pliers		1	145 mm
			12 42 195	KNIPEX MultiStrip 10, Automatic Insulation Stripper		1	195 mm
			13 86 200	Pliers for Electrical Installation		1	200 mm
			16 95 01 SB	KNIPEX ErgoStrip®, Universal Stripping Tool		1	135 mm
			26 26 200	Snipe Nose Side Cutting Pliers, (Stork Beak Pliers)		1	200 mm
			70 06 160	Diagonal Cutter		1	160 mm
			74 06 200	High Leverage Diagonal Cutter		1	200 mm
			86 03 180	Pliers Wrench		1	180 mm
			87 01 180	KNIPEX Cobra®, Hightech Water Pump Pliers		1	180 mm
			97 53 04	Self-Adjusting Crimping Pliers for wire end sleeves		1	180 mm
			98 52	Cable Knife		1	185 mm
			98 25 01 SL	Screwdrivers (Slim) for cross-recessed screws, Pozidriv®		1	PZ 1 x 80 mm
			98 20 35 SL	Screwdriver (Slim) for slotted screws		1	0,6 x 3.5x100mm
				Kraftform Kompakt VDE 16 extra slim 1, 16 parts	Wera	1	
				Zyklus set of metal ratchets, 8100 SA 8, 28 parts	Wera	1	1/4"
				Joker open-end wrench	Wera	1	10 x 13 mm
				Locksmith's hammer	Picard	1	300 g
				Electrician's Chisel	Rennsteig	1	250 x 10 mm
				Spirit level type 70 Electric	Stabila	1	430 mm
				Pocket Electric mini spirit level	Stabila	1	68 mm
00 21 42 LE	084211		Tool Case "BIG Twin", empty				7200



Tool Case "BIG Twin Move RED" Electro Competence

Better safe than sorry: 47 insulated brand tools for work on electrical systems

- ▶ Hard-wearing ABS material construction, red; equipped with a range of KNIPEX tools for working on electrical systems, tested according to DIN EN/IEC 60900
- ▶ Telescopic handle set in the base as well as two external, smooth-running skater wheels
- ▶ Free-standing in all opening positions thanks to snap-in cover holders with hinge mechanism on both sides, angle freely adjustable
- ▶ Can be opened from one or both sides; bottom and lid can be opened independently of each other
- ▶ Max. payload: 30 kg
- ▶ Volume: 44 litres





















98 99 15













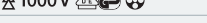

- > Label field with two stickers for individual labelling
- > Circumferential aluminium frame with securely mounted, sturdy centre wall that can be fitted on both sides, with versatile inserting options due to elasticated loops and twelve small pockets
- > Metal hinges
- > Three-digit combination lock for secure locking of the case
- > Two metal flip locks each for fixing the cover and the base
- > Removable document compartment and removable tool boards made from dirt-repellent PP twin-wall sheets with 13 tool pockets
- > Base tray, can be fixed by press button, height 58 mm, can be subdivided by flexible inserts; cover plate with six large compartments
- > Dimensions, exterior (W x H x D): 520 x 435 x 290 mm
- > Dimensions, interior (W x H x D): 490 x 370 x 110/100 mm
- > IEC 60900, DIN EN 60900
- > With a total of 95 inserting options



98 99 15 LE
Case supplied without tools

Content overview

70 06 160 KNIPEX		6 x 98 00 XX KNIPEX		9 x 98 47 XX KNIPEX		98 25 02 SLS KNIPEX	
08 26 145 KNIPEX		6 x 98 01 XX KNIPEX		6 x 98 64 02 KNIPEX		2 x 98 24 XX SL KNIPEX	
11 06 160 KNIPEX		98 42 KNIPEX		98 20 25 KNIPEX		98 52 KNIPEX	
87 26 250 KNIPEX		98 40 KNIPEX		3 x 98 20 XX SL KNIPEX		98 53 03 KNIPEX	
95 16 200 KNIPEX		2 x 98 45 XXX KNIPEX		2 x 98 25 XX SL KNIPEX			

Article No.	EAN 4003773-				Number	Nominal size	g
98 99 15	084341		Tool Case "BIG Twin Move RED", 47 parts				15450
			08 26 145	Needle-Nose Combination Pliers	1	145 mm	
			11 06 160	Insulation Stripper	1	160 mm	
			70 06 160	Diagonal Cutter	1	160 mm	
			87 26 250	KNIPEX Cobra®, Hightech Water Pump Pliers	1	250 mm	
			95 16 200	Cable Shears with twin cutting edge	1	200 mm	
			98 00 10	Open-end wrench	1	10 mm	
			98 00 13		1	13 mm	
			98 00 14		1	14 mm	
			98 00 17		1	17 mm	
			98 00 19		1	19 mm	
			98 00 22	Box Wrench	1	22 mm	
			98 01 10		1	10 mm	
			98 01 13		1	13 mm	
			98 01 14		1	14 mm	
			98 01 17		1	17 mm	
			98 01 19		1	19 mm	
			98 01 22		1	22 mm	
			98 20 25	Screwdrivers for slotted screws	1	0.4 x 2.5 x 75 mm	
			98 20 40 SL	Screwdriver (Slim) for slotted screws	1	0.8 x 4.0 x 100 mm	
			98 20 55 SL		1	1.0 x 5.5 x 125 mm	
			98 20 65 SL		1	1.2 x 6.5 x 150 mm	
			98 25 01 SL	Screwdrivers (Slim) for cross-recessed screws, Pozidriv®	1	PH1 x 80 mm	
			98 25 02 SL		1	PH2 x 100 mm	
			98 25 02 SLS	Screwdrivers (Slim) Plus/Minus Pozidriv®	1	PZ/S 2 x 100	
			98 24 01 SL	Screwdrivers (Slim) for cross-recessed screws Phillips®	1	PH1 x 80 mm	
			98 24 02 SL		1	PH2 x 100 mm	
			98 40	T-Handle Drive with driving square 1/2"	1	165 mm	
			98 42	Reversible Ratchet with driving square 1/2"	1	1/2"	
			98 45 125	Extension Bar with internal/external square 1/2"	1	1/2"	
			98 45 250		1	1/2"	
			98 47 10	Hexagon Socket for hexagonal screws with internal square 1/2"	1	1/2" / 10 mm	
			98 47 11		1	1/2" / 11 mm	
			98 47 12		1	1/2" / 12 mm	
			98 47 13		1	1/2" / 13 mm	
			98 47 14		1	1/2" / 14 mm	
			98 47 17		1	1/2" / 17 mm	
			98 47 19		1	1/2" / 19 mm	
			98 47 22		1	1/2" / 22 mm	
			98 47 24		1	1/2" / 24 mm	
			98 52		Cable Knife	1	185 mm
			98 53 03	Dismantling Knife for round cables	1	155 mm	
			98 64 02	Insulating Clamp of plastic	6	150 mm	
98 99 15 LE	084334		Tool Case "BIG Twin Move RED", empty				8600

"Robust"

Optimum tool transport even under the toughest conditions



Tool Case "Robust"

The name says it all: ideal for outdoor use

► For the toughest conditions: Dust-tight, waterproof and temperature-resistant

- > Fit-to-fly case, made from impact-resistant polypropylene
- > Dustproof and watertight
- > Air pressure compensation valve
- > Temperature-resistant from -30°C until + 80°C
- > Padlock eyelets
- > Document compartment; tool boards made from dirt-repellent PP twin-wall sheets with tool pockets and straps
- > Lockable base tray can be individually divided using aluminium separator system
- > Ergonomic dual-component handle



Pressure valve for venting and name plate for individual labelling



Document compartment



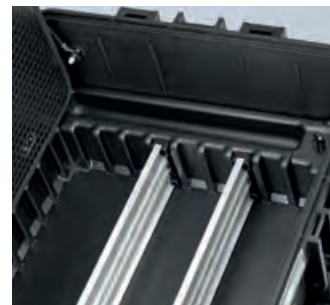

Device for securing with a padlock (lock not included)



Aluminium separators for individual division of the base tray

The "Robust" cases compared:

	Number of inserting options	Litre capacity	Max. payload kg	Dimensions base tray mm	Trolley function
"Robust23" 00 21 35 LE 	49	23	25	470 x 370 x 190	—
"Robust34" 00 21 36 LE 	93	34	25	510 x 419 x 215	—
"Robust45 Move" 00 21 37 LE 	147	45	35	609 x 428 x 263	✓



Also suitable as a standing or sitting aid



Case locking via robust flip locks



Secure fastening of the tool board prevents tools from falling out of the base

Tool Case "Robust23" Electro

Small and robust: handy case with tools for professional electricians

- ▶ Equipped with 25 brand tools, partly VDE-tested according to DIN EN 60900
- ▶ Max. payload: 25 kg
- ▶ Volume: 23 litres
- > Document compartment; tool boards made from dirt-repelling twin-wall PP sheets with space for 33 tool pockets and various tool straps
- > With a total of 49 inserting options
- > Base tray with aluminium separators
- > Dimensions, exterior (W x H x D): 470 x 370 x 190 mm
- > Dimensions, interior (W x H x D): 437 x 307 x 172 mm
- > **For further benefits of the case, see page 303**

00 21 35 LE
Case supplied without tools



00 21 35

Content overview

12 40 200 KNIPEX		70 06 160 KNIPEX		97 53 04 KNIPEX		16 parts Wera	
13 86 200 KNIPEX		87 01 180 KNIPEX		98 52 KNIPEX		Stabila	
16 95 01 SB KNIPEX							



With adjustable carrying strap and comfortable multi-component handle



00 21 35 LE – Case supplied without tools

Article No.	EAN				Number	Nominal size	⚖ g
00 21 35	4003773-084365			Tool Case "Robust23" Electro, 25 parts			6800
		MM	12 40 200	Self-Adjusting Insulation Stripper	KNIPEX	1	200 mm
		⚠ 1000 V ⚡ ⚙ ⚙ ⚙	13 86 200	Pliers for Electrical Installation		1	200 mm
		MM	16 95 01 SB	KNIPEX ErgoStrip® Universal Stripping Tool		1	135 mm
		⚠ 1000 V ⚡ ⚙ ⚙	70 06 160	Diagonal Cutter		1	160 mm
		⚙	87 01 180	KNIPEX Cobra®, Hightech Water Pump Pliers		1	180 mm
		MM	97 53 04	Self-Adjusting Crimping Pliers for wire end sleeves		1	180 mm
		⚠ 1000 V ⚡ ⚙	98 52	Cable Knife		1	190 mm
				Kraftform Kompakt VDE 16 extra slim 1, 16 parts	Wera	1	
				Ruler Stabila Serie 400	Stabila	1	185 mm
00 21 35 LE	077596			Tool Case "Robust23", empty			4800

Tool Case "Robust34" Electro

Medium-sized and robust: sturdy case with tools for professional electricians

- ▶ Equipped with 26 brand tools, partly VDE-tested according to DIN EN 60900
- ▶ Max. payload: 25 kg
- ▶ Volume: 34 litres

- > Document compartment; tool boards made from dirt-repelling twin-wall PP sheets with space for 38 tool pockets and various tool straps
- > With a total of 93 inserting options
- > Base tray with aluminium separators
- > Dimensions, exterior (W x H x D): 510 x 419 x 215 mm
- > Dimensions, interior (W x H x D): 480 x 356 x 199 mm

> **For further benefits of the case, see page 303**

00 21 36 LE
Case supplied without tools



00 21 36

Content overview

00 11 01 KNIPEX		13 86 200 KNIPEX		87 01 180 KNIPEX		16 parts Wera	
08 26 145 KNIPEX		16 95 01 SB KNIPEX		97 53 04 KNIPEX		Stabila	
12 40 200 KNIPEX		70 06 160 KNIPEX		98 52 KNIPEX			



With adjustable carrying strap and comfortable multi-component handle



00 21 36 LE – Case supplied without tools



Article No.	EAN				Number	Nominal size	g
00 21 36	4003773-082583		Tool Case "Robust34" Electro, 26 parts				10000
			00 11 01	KNIPEX TwinKey®, Control Cabinet Key	KNIPEX	1	
		⚠ 1000 V ⚡	08 26 145	Needle-Nose Combination Pliers		1	145 mm
		⚡	12 40 200	Self-Adjusting Insulation Stripper		1	200 mm
		⚠ 1000 V ⚡	13 86 200	Pliers for Electrical Installation		1	200 mm
		⚡	16 95 01 SB	KNIPEX ErgoStrip®, Universal Stripping Tool		1	135 mm
		⚠ 1000 V ⚡	70 06 160	Diagonal Cutter		1	160 mm
		⚡	87 01 180	KNIPEX Cobra®, Hightech Water Pump Pliers		1	180 mm
		⚡	97 53 04	Self-Adjusting Crimping Pliers for wire end sleeves with lateral access		1	180 mm
		⚠ 1000 V ⚡	98 52	Cable Knife		1	185 mm
		⚠ 1000 V ⚡		Kraftform Kompakt VDE 16 extra slim 1, 16 parts		Wera	1
				Spirit level type 70 Electric	Stabila	1	430 mm
00 21 36 LE	082576		Tool Case "Robust34", empty				7100

Tool Case "Robust45 Move" Electro

Large and robust: travel case with a comprehensive range of tools for the mobile electrician

- ▶ Extensively equipped with 63 brand tools, partly VDE-tested according to DIN EN 60900
- ▶ Max. payload: 35 kg
- ▶ Volume: 45 litres
- > Gas pressure absorber in the hinge
- > Pneumatically cushioned lid
- > Document compartment; tool boards made from dirt-repelling twin-wall PP sheets with space for 46 tool pockets and various tool straps
- > With a total of 147 inserting options
- > Base tray with aluminium separators
- > Extendable telescopic handle for comfortable transport
- > Large smooth-running wheels
- > Dimensions, exterior (W x H x D): 609 x 428 x 263 mm
- > Dimensions, interior (W x H x D): 540 x 364 x 229 mm

> For further benefits of the case, see page 303

00 21 37 LE
Case supplied without tools

Gas pressure absorber in the hinge: convenient opening of the lid, with no risk of injury from the case closing inadvertently



00 21 37



With large smooth-running wheels



Extendable telescopic handle

Content overview

00 11 01 KNIPEX		26 26 200 KNIPEX		97 53 04 KNIPEX		Wera	
08 26 145 KNIPEX		70 06 160 KNIPEX		98 52 KNIPEX		16 parts Wera	
12 42 195 KNIPEX		74 06 200 KNIPEX		2 x 98 2X XX SL KNIPEX		Stabila	
13 86 200 KNIPEX		86 03 180 KNIPEX		Picard		Stabila	
16 95 01 SB KNIPEX		87 01 180 KNIPEX		Wera		Rennsteig	



Handles on left and right permit comfortable carrying with two people



With telescopic handle for comfortable transport – even on uneven terrain



00 21 37 LE – Case supplied without tools

Article No.	EAN					Number	Nominal size	g
00 21 37	4003773-082606		Tool Case "Robust45 Move" Electro, 63 parts					15000
			00 11 01	KNIPEX TwinKey®, Control Cabinet Key	KNIPEX	1		
		⚡ 1000 V ⚠️ ⚙️ ⚙️	08 26 145	Needle-Nose Combination Pliers		1	145 mm	
		⚡	12 42 195	KNIPEX MultiStrip 10, Automatic Insulation Stripper		1	195 mm	
		⚡ 1000 V ⚠️ ⚙️ ⚙️ ⚙️	13 86 200	Pliers for Electrical Installation		1	200 mm	
		⚡	16 95 01 SB	KNIPEX ErgoStrip®, Universal Stripping Tool		1	135 mm	
		⊖ ⚙️ ⚙️	26 26 200	Snipe Nose Side Cutting Pliers		1	200 mm	
		⚡ 1000 V ⚠️ ⚙️ ⚙️	70 06 160	Diagonal Cutter		1	160 mm	
		⚡ 1000 V ⚠️ ⚙️ ⚙️	74 06 200	High Leverage Diagonal Cutter		1	200 mm	
		⚙️	86 03 180	Pliers Wrench		1	180 mm	
		⚙️	87 01 180	KNIPEX Cobra®, Hightech Water Pump Pliers		1	180 mm	
		⚡ ⚡	97 53 04	Self-Adjusting Crimping Pliers for wire end sleeves		1	180 mm	
		⚡ 1000 V ⚠️ ⚙️	98 52	Cable Knife		1	190 mm	
		⚡ 1000 V ⚠️ ⚙️ ⚙️	98 25 01 SL	VDE-screwdriver PZ1		1	PZ1x80mm	
		⚡ 1000 V ⚠️ ⚙️ ⚙️	98 20 35 SL	VDE-screwdriver 3,5		1	0.6 x 3.5 x 100 mm	
				Locksmith's hammer, 300g		Picard	1	
				Zyklop set of metal ratchets, 8100 SA 8, 28 parts		1	1/4"	
				Joker open-end wrench	Wera	1	10x13 mm	
		⚡ 1000 V ⚠️ ⚙️		Kraftform Kompakt VDE 16 extra slim 1, 16 parts		1		
				Pocket Electric spirit level	Stabila	1	68 mm	
				Spirit level type 70 Electric		1	430 mm	
				Electrician's Chisel	Rennsteig	1	250x10mm	
00 21 37 LE	082590		Tool Case "Robust45 Move", empty					10800

Tool Case "Robust45 Move" Mechanics

All-round equipment for professional mechanics

- ▶ Extensively equipped with 79 brand tools, partly VDE-tested according to DIN EN 60900
- ▶ Max. payload: 35 kg
- ▶ Volume: 45 litres

- > Gas pressure absorber in the hinge
- > Pneumatically cushioned lid
- > Document compartment; tool boards made from dirt-repelling twin-wall PP sheets with space for 46 tool pockets and various tool straps
- > With a total of 147 inserting options
- > Base tray with aluminium separators
- > Extendable telescopic handle for comfortable transport
- > Large smooth-running wheels
- > Dimensions, exterior (W x H x D): 609 x 428 x 263 mm
- > Dimensions, interior (W x H x D): 540 x 364 x 229 mm

> For further benefits of the case, see page 303

00 21 37 LE

Case supplied without tools

Gas pressure absorber in the hinge: convenient opening of the lid, with no risk of injury from the case closing inadvertently



00 21 37 M



With large smooth-running wheels



Extendable telescopic handle

Content overview

00 11 01 KNIPEX		26 22 200 KNIPEX		20 x Wera		Stabila	
70 02 160 KNIPEX		78 61 140 KNIPEX		Picard		Heyco	
74 02 200 KNIPEX		16 95 01 SB KNIPEX		Wera		Rennsteig	
71 31 200 KNIPEX		16 20 50 SB KNIPEX		Wera		Rennsteig	
26 12 200 KNIPEX		86 01 250 KNIPEX		Stabila			

Article No.	EAN 4003773-				Number	Nominal size	⚖ g
00 21 37 M	086222		Tool Case "Robust45 Move" Mechanics, 79 parts				12800
			00 11 01	KNIPEX TwinKey®, Control Cabinet Key	KNIPEX	1	
			70 02 160	Diagonal Cutter		1	160 mm
			74 02 200	High Leverage Diagonal Cutter		1	200 mm
			71 31 200	KNIPEX CoBolt® Compact Bolt Cutters		1	200 mm
			26 12 200	Snipe Nose Side Cutting Pliers		1	200 mm
			26 22 200	Snipe Nose Side Cutting Pliers		1	200 mm
			78 61 140	Electronic Super Knips® XL		1	140 mm
			16 95 01 SB	KNIPEX ErgoStrip®, Universal Stripping Tool		1	135 mm
			16 20 50 SB	Folding Knife for Electricians		1	120 mm
			86 01 250	Pliers Wrench		1	250 mm
			87 01 250	KNIPEX Cobra®, Hightech Water Pump Pliers		1	250 mm
				350 PH Screwdriver for Phillips screws		1	PH1 x 80 mm
				917 SPH Screwdriver for Phillips screws		1	PH2 x 100 mm
				350 PH Screwdriver for Phillips screws		1	PH3 x 150 mm
				355 PZ Screwdriver for Phillips screws	1	PZ1 x 80 mm	
				355 PZ Screwdriver for Phillips screws	1	PZ2 x 100 mm	
				355 PZ Screwdriver for Phillips screws	1	PZ3 x 150 mm	
				335 Screwdriver for slotted screws	1	3,5 x 100 mm	
				335 Screwdriver for slotted screws	1	4,0 x 100 mm	
				932 A Screwdriver for slotted screws	1	5,5 x 100 mm	
				932 A Screwdriver for slotted screws	1	7,0 x 125 mm	
				932 A Screwdriver for slotted screws	1	7,0 x 125 mm	
				367 Screwdriver for TORX® screws	1	TX 10x80	
				367 Screwdriver for TORX® screws	1	TX 15x80	
				367 Screwdriver for TORX® screws	1	TX 20x100	
				367 Screwdriver for TORX® screws	1	TX 25x100	
				367 Screwdriver for TORX® screws	1	TX 30x115	
				2050 Screwdriver for Phillips screws	1	PH0 x 60 mm	
				2050 Screwdriver for Phillips screws	1	PH00 x 60 mm	
				2035 Screwdriver for slotted screws	1	1,5 x 60 mm	
				2035 Screwdriver for slotted screws	1	2,5 x 80 mm	
				Locksmith's hammer	Picard	1	300 g
				8100 SA 8 Zyklop set of metal ratchets, 28 parts	Wera	1	1/4"
				Set of hex key wrenches	Wera	1	1,5 - 10 mm
				Wooden folding rule	KNIPEX	1	185 mm
				Spirit level type 70 Electric	Stabila	1	430 mm
				Combination wrench set	Heyco	1	
				Set of parallel pin punches	Rennsteig	1	
				Automatic centre punch		1	130 mm
00 21 37 LE	082590		Tool Case "Robust45 Move", empty				10800

Tool Case "Vision24" Electro

Well sorted and tidy: the standard tool case with versatile basic equipment

- ▶ Equipped with 20 brand tools, partly VDE-tested according to DIN EN 60900
- ▶ Max. payload: 20 kg
- ▶ Volume: 24 litres
- > Flexible options due to the individual partitioning of the inserts in the 60 mm deep base tray and its cover plate with six large tool compartments
- > Tough ratchet hinges hold the lid open where necessary despite the deadweight of the tools
- > Strong, ergonomic handle, snaps into place at a 90° angle
- > Removable tool board with 15 tool pockets on the base side and six tool pockets as well as a clamp compartment (400 mm wide) on the cover side, held by a push button
- > Two lockable steel flip locks protect the case contents from theft
- > With circumferential double aluminium frame
- > Rugged design made of ABS material, black
- > Cover and tool boards made from dirt-repellent PP twin-wall sheets
- > Dimensions, exterior (W x H x D): 480 x 380 x 180 mm
- > Dimensions, interior (W x H x D): 460 x 310 x 170 mm



00 21 20



00 21 20 LE
Case supplied without tools

Article No.	EAN				Number	Nominal size	⚖ g
00 21 20	4003773-052166		Tool Case "Vision24" Electro, 20 parts				7225
		⚠ 1000 V	03 06 180	Combination Pliers	1	180 mm	
		⚠	12 40 200	Self-Adjusting Insulation Stripper	1	200 mm	
			16 95 01 SB	KNIPEX ErgoStrip®, Universal Stripping Tool	1	135 mm	
		⚠ 1000 V	26 16 200		1	200 mm	
		⚠ 1000 V	26 26 200	Snipe Nose Side Cutting Pliers (Stork Beak Pliers)	1	200 mm	
		⚠ 1000 V	70 06 160	Diagonal Cutter	1	160 mm	
			74 06 200	High Leverage Diagonal Cutter	1	200 mm	
			86 03 180	Pliers Wrench	1	180 mm	
			87 03 250	KNIPEX Cobra®, Hightech Water Pump Pliers	1	250 mm	
		⚠ 1000 V	95 16 200	Cable Shears with twin cutting edge	1	200 mm	
		⚠ 1000 V	98 20 25	Screwdrivers for slotted screws	1	0.6 x 3.5 x 100 mm	
			98 20 65 SL		1	1.2 x 6.5 x 150 mm	
		⚠ 1000 V	98 20 55 SL	Screwdriver (Slim) for slotted screws	1	1.0 x 5.5 x 125 mm	
			98 20 40 SL		1	0.6 x 3.5 x 100 mm	
		⚠ 1000 V	98 24 01 SL	Screwdrivers for cross recessed Phillips® screws	1	PH1 x 80 mm	
			98 24 02 SL		1	PH2 x 80 mm	
		⚠ 1000 V	98 25 01 SL	Screwdrivers for cross recessed Pozidriv® screws	1	PZ1 x 80 mm	
			98 25 02 SL		1	PZ2 x 80 mm	
		⚠ 1000 V	98 52	Cable Knife	1	185 mm	
				Voltage detector, single-pole, 247	1	0.5 x 3.0 x 70 mm	
00 21 20 LE	044567		Tool Case "Vision24", empty				4485

Tool Case "Vision27" Sanitary

Flexible and extensively equipped: large plumbing range for professionals

► Equipped with 52 brand tools, partly VDE-tested according to DIN EN 60900

► Max. payload: 20 kg

► Volume: 27 litres

- > For extensive plumbing and installation work
- > Flexible options due to the individual partitioning of the inserts in the 60 mm deep base tray and its cover plate with six large tool compartments
- > Tough ratchet hinges hold the lid open where necessary despite the deadweight of the tools
- > Strong, ergonomic handle, snaps into place at a 90° angle
- > Removable tool board with 15 tool pockets on the base side and six tool pockets as well as a clamp compartment (400 mm wide) on the cover side, held by a push button
- > Two lockable steel flip locks protect the case contents from theft
- > With circumferential double aluminium frame
- > Rugged design made of ABS material, black
- > Cover and tool boards made from dirt-repellent PP twin-wall sheets
- > Dimensions, exterior (W x H x D): 480 x 380 x 200 mm
- > Dimensions, interior (W x H x D): 460 x 310 x 190 mm



00 21 21 HK S

Article No.	EAN				Number	Nominal size	g
00 21 21 HK S	4003773-080671		Tool Case "Vision27" Sanitary, 52 parts		1		9600
			86 03 180 Pliers Wrench	KNIPEX	1	180 mm	
			87 01 250 KNIPEX Cobra®, Hightech Water Pump Pliers		1	250 mm	
			87 01 400 KNIPEX Cobra® XL, Hightech Water Pump Pliers		1	400 mm	
			74 06 180 High Leverage Diagonal Cutter		1	180 mm	
			26 16 200 Snipe Nose Side Cutting Pliers, (Stork Beak Pliers)		1	200 mm	
			00 11 01 KNIPEX TwinKey®, Control Cabinet Key	1			
			Screwdrivers for slotted screws, 160i	Wera	1	0.6 x 3.5 x 100 mm	
			Screwdrivers for slotted screws, 160i		1	1.0 x 5.5 x 125 mm	
			Screwdriver for Torx® screws, 167i		1	TX15 x 80 mm	
			Screwdriver for Torx® screws, 167i		1	TX20 x 80 mm	
			Screwdriver for Torx® screws, 167i		1	TX25 x 80 mm	
			Screwdrivers for cross recessed Phillips® screws, 162i PH		1	PH1 x 80 mm	
			Screwdrivers for cross recessed Phillips® screws, 162i PH		1	PH2 x 100 mm	
			Slotted chisel, 932 A		1	1.2 x 7.0 x 125 mm	
			Slotted chisel, 932 A		1	1.6 x 9.0 x 150 mm	
			Voltage detector, single-pole, 247		1	0.5 x 3.0 x 70 mm	
			Zyklop set of metal ratchets 8100 SA 8, 28 parts	1	1/4"		
			Joker open-end wrench	1	10 x 13 mm		
			Set of hex key wrenches	1	1.5 - 10 mm		
			Express key	Heyco	1	17 x 19 mm M 10	
			Safety cutter knife		1	18 mm	
			Locksmith's hammer	Picard	1	300 g	
			Mason's Chisels	Rennsteig	1	250 mm	
			Spirit level type 70	Stabila	1	30 cm	

Tool Case "Focus" Electro

Roomy and variable: the power tool case with large base tray and tool range

- ▶ Equipped with 23 brand tools, partly VDE-tested according to DIN EN 60900
 - ▶ 90 mm deep base tray with variable compartments (e.g. for measuring and testing instruments)
 - ▶ Max. payload: 25 kg
 - ▶ Volume: 35 litres
- > Sturdy ABS hard-shell construction with aluminium frame and wraparound buffer protection
 - > Document compartment and pen holding straps
 - > One removable tool plate, with elastic loops on both sides
 - > One cover plate with elastic loops and tool protection cloth
 - > Sturdy metal locks and three-digit combination lock protect the contents of the case
 - > Strong, ergonomic handle
 - > Feet on both sides
 - > Colour: silver, aluminium look
 - > Dimensions, exterior (W x H x D): 520 x 420 x 210 mm
 - > Dimensions, interior (W x H x D): 480 x 360 x 200 mm



00 21 30



00 21 30 LE
Case supplied without tools

Article No.	EAN				Number	Nominal size	g
00 21 30	4003773-051084		Tool Case "Focus" Electro, 23 parts				9440
			00 11 01	KNIPEX TwinKey®, Control Cabinet Key	1		
		⚠ 1000 V	03 06 180	Combination Pliers	1	180 mm	
		MM	12 40 200	Self-Adjusting Insulation Stripper	1	200 mm	
			16 95 01 SB	KNIPEX ErgoStrip®, Universal Stripping Tool	1	135 mm	
		⚠ 1000 V	26 16 200	Snipe Nose Side Cutting Pliers (Stork Beak Pliers)	1	200 mm	
		⚠ 1000 V	26 26 200		1	200 mm	
		⚠ 1000 V	70 06 125	Diagonal Cutter	1	125 mm	
		⚠ 1000 V	70 06 160		1	160 mm	
			86 03 180	Pliers Wrench	1	180 mm	
			87 03 250	KNIPEX Cobra®, Hightech Water Pump Pliers	1	250 mm	
		⚠ 1000 V	92 27 62	Precision Tweezers, insulated	1	150 mm	
		⚠ 1000 V	98 20 25	Screwdrivers for slotted screws	1	0.4 x 2.5 x 75 mm	
			98 20 35 SL		1	0.6 x 3.5 x 100 mm	
		⚠ 1000 V	98 20 40 SL		1	0.8 x 4.0 x 100 mm	
			98 20 55 SL		1	1.0 x 5.5 x 125 mm	
			98 20 65 SL		1	1.2 x 6.5 x 150 mm	
		⚠ 1000 V	98 20 80		1	1.2 x 8.0 x 175 mm	
		⚠ 1000 V	98 24 00	Screwdrivers for cross recessed Phillips® screws	1	PH0 x 60 mm	
		⚠ 1000 V	98 24 01 SL	Screwdrivers (Slim) for cross-recessed screws, Phillips®	1	PH1 x 80 mm	
			98 24 02 SL		1	PH2 x 100 mm	
		⚠ 1000 V	98 25 01 SL	Screwdrivers for cross recessed Pozidriv® screws	1	PZ1 x 80 mm	
			98 25 02 SL		1	PZ2 x 100 mm	
00 21 30 LE	060697		Tool Case "Focus", empty				5450

KNIPEX L-BOXX®

Ideal storage and transport solution: the KNIPEX L-BOXX®

- ▶ Strong box made of impact- and shock-proof ABS plastic
- ▶ Max. payload: 25 kg
- > Splash-proof
- > Several boxes can be securely joined together
- > Flexible inner partitions
- > Handle can be lowered into a hollow in the lid to save space
- > Ergonomically shaped handles with additional moulded recess on the side for flexible, convenient handling
- > With two-piece tool board made from dirt-repellent PP twin-wall sheets
- > Tool holders are connected to each other using hook-and-loop
- > Cover part with ten pockets and ten elastic straps
- > Top of base part with seven pockets and tab for hanging up the tool card; can also be used to lift and set up the L-BOXX®
- > Bottom of base part with 7 pockets and 7 elastic straps
- > Dimensions, exterior (W x H x D): 442 x 442 x 151 mm
- > Dimensions, interior (W x H x D): 375 x 311 x 107 mm



00 21 19 LB
Case empty, with tool card



00 21 19 LB LE
Case empty, without tool card



00 21 19 LB WK
Tool card, individually available



The boxes are stackable and can be securely joined together



A lock can be attached to secure the device
(lock not included in delivery)



Washable tool boards

Article No.	EAN		g
00 21 19 LB	081616	KNIPEX L-BOXX®, empty, with tool card	3200
00 21 19 LB WK	081609	Two-part tool holder for KNIPEX L-BOXX®	953
00 21 19 LB LE	081975	KNIPEX L-BOXX®, empty, without tool card	2200

KNIPEX L-BOXX® Electro

Ideal storage and transport solution: the KNIPEX L-BOXX® with a large range of tools for professional electricians

► Equipped with 14 KNIPEX tools, a total of 63 brand tools, partly VDE-tested according to DIN EN 60900

> For further benefits of the case, see page 315



00 21 19 LB E

Content overview

00 11 01 KNIPEX		26 26 200 KNIPEX		97 53 04 KNIPEX		Wera	
08 26 145 KNIPEX		70 06 160 KNIPEX		98 52 KNIPEX		Picard	
12 42 195 KNIPEX		74 06 200 KNIPEX		2 x 98 2X XX KNIPEX		Rennsteig	
13 86 200 KNIPEX		86 03 180 KNIPEX		16 parts Wera		Stabila	
16 95 01 SB KNIPEX		87 01 180 KNIPEX		28 parts Wera		Stabila	

Article No.	EAN 4003773-				Number	Nominal size	g	
00 21 19 LB E	081623		KNIPEX L-BOXX® Electro, 63 parts				7800	
			00 11 01	KNIPEX TwinKey®, Control Cabinet Key	KNIPEX			
			08 26 145	Needle-Nose Combination Pliers		1	145 mm	
			12 42 195	KNIPEX MultiStrip 10, Automatic Insulation Stripper		1	195 mm	
			13 86 200	Pliers for Electrical Installation		1	200 mm	
			16 95 01 SB	KNIPEX ErgoStrip®, Universal Stripping Tool		1	135 mm	
			26 26 200	Snipe Nose Side Cutting Pliers (Stork Beak Pliers)		1	200 mm	
			70 06 160	Diagonal Cutter		1	160 mm	
			74 06 200	High Leverage Diagonal Cutter		1	200 mm	
			86 03 180	Pliers Wrench		1	180 mm	
			87 01 180	KNIPEX Cobra®, Hightech Water Pump Pliers		1	180 mm	
			97 53 04	Self-Adjusting Crimping Pliers for wire end sleeves		1	180 mm	
			98 52	Cable Knife		1	185 mm	
			98 25 01 SL	Screwdrivers (Slim) for cross-recessed screws, Pozidriv®		1	PZ 1 x 80 mm	
			98 20 35 SL	Screwdriver (Slim) for slotted screws		1	0.6 x 3.5 x 100 mm	
				Kraftform Kompakt VDE 16 extra slim 1, 16 parts	Wera	1		
				Zyklop set of metal ratchets, 8100 SA 8, 28 parts	Wera	1	1/4"	
				Joker open-end wrench	Wera	1	10 x 13 mm	
				Locksmith's hammer	Picard	1	300 g	
				Electrician's Chisel	Rennsteig	1	250 x 10 mm	
				Spirit level type 70 Electric	Stabila	1	430 mm	
				Pocket Electric mini spirit level	Stabila	1	68 mm	
00 21 19 LB	081616		KNIPEX L-BOXX®, empty, with tool card				3200	
00 21 19 LB WK	081609		Two-part tool holder for KNIPEX L-BOXX®				953	
00 21 19 LB LE	081975		KNIPEX L-BOXX®, empty, without tool card				2200	

KNIPEX L-BOXX® Sanitary

Ideal storage and transport solution: the KNIPEX L-BOXX® with a large range of tools for the sanitary, heating and air-conditioning professional

► Equipped with 13 KNIPEX tools, a total of 52 brand tools, partly VDE-tested according to DIN EN 60900

> For further benefits of the case, see page 315



00 21 19 LB S

Content overview

00 11 01 KNIPEX		87 01 400 KNIPEX		9-teilig Wera		Picard	
26 16 200 KNIPEX		7 x 98 2X XX KNIPEX		Heyco		Stabila	
74 06 180 KNIPEX		Wera		Heyco		Stabila	
86 03 250 KNIPEX		28-teilig Wera		Rennsteig		Zenten	
87 01 250 KNIPEX		Wera		Rennsteig			

Article No.	EAN 4003773-				Number	Nominal size	g
00 21 19 LB S	081630		KNIPEX L-BOXX® Sanitary, 52 parts				9400
			00 11 01	KNIPEX TwinKey®, Control Cabinet Key	1		
			26 16 200	Snipe Nose Side Cutting Pliers (Stork Beak Pliers)	1	200 mm	
			74 06 180	High Leverage Diagonal Cutter	1	180 mm	
			86 03 250	Pliers Wrench	1	250 mm	
			87 01 250	KNIPEX Cobra®, Hightech Water Pump Pliers	1	250 mm	
			87 01 400	KNIPEX Cobra® XL, Hightech Water Pump Pliers	1	400 mm	
			98 20 35	Screwdrivers for slotted screws	1	0.6 x 3.5 x 100 mm	
			98 20 55	Screwdrivers for slotted screws	1	1.0 x 5.5 x 125 mm	
			98 26 15	Screwdriver for Torx® screws	1	TX15 x 80 mm	
			98 26 20	Screwdriver for Torx® screws	1	TX20 x 80 mm	
			98 26 25	Screwdriver for Torx® screws	1	TX25 x 80 mm	
			98 24 01	Screwdrivers for cross-recessed screws, Phillips®	1	PH1 x 80 mm	
			98 24 02	Screwdrivers for cross-recessed screws, Phillips®	1	PH2 x 100 mm	
				Voltage detector, single-pole, 247	1	0.5 x 3.0 x 70 mm	
				Zyklus set of metal ratchets, 8100 SA 8, 28 parts	1	1/4"	
				Joker open-end wrench	1	10 x 13 mm	
				Set of hex key wrenches	1	1.5 - 10 mm	
				Express key	1	17 x 19 mm M 10	
				Safety cutter knife	1	18 mm	
				Electrician's Chisel	1	250 x 10 mm	
				Mason's Chisels	1	250 mm	
				Locksmith's hammer	1	300 g	
				Spirit level type 70	1	30 cm	
				Metre ruler (yardstick)	1	2 m	
				Pipe cutter	1	3 - 35 mm / 1/8 - 1 1/2"	
00 21 19 LB	081616		KNIPEX L-BOXX®, empty, with tool card				3200
00 21 19 LB WK	081609		Two-part tool holder for KNIPEX L-BOXX®				953
00 21 19 LB LE	081975		KNIPEX L-BOXX®, empty, without tool card				2200

Tool bag "Classic" Electro

Tried-and-tested: the handy tool bag with tool equipment

► Equipped with 23 brand tools, partly VDE-tested according to DIN EN 60900

- > Light design made of hard-wearing, reinforced polyester fabric
- > Front additionally reinforced with aluminium brackets
- > Semi-fold-out front with adjustable loops and exterior document compartment
- > With galvanized steel base tray
- > With carrying handle and adjustable shoulder strap
- > Dimensions, exterior (W x H x D): 440 x 270 x 180 mm
- > Dimensions, interior (W x H x D): 420 x 250 x 160 mm



00 21 02 EL



00 21 02 LE
Bag without tools

Article No.	EAN					Number	Nominal size	g
00 21 02 EL	4003773-081951			Tool bag "Classic" Electro, 23 parts				6700
		⚡ 1000 V	🔧	03 06 180	Combination Pliers	1	180 mm	
		⚡ 1000 V	🔧	11 06 160	Insulation Stripper	1	160 mm	
		⚡ 1000 V	🔧	25 06 160	Snipe Nose Side Cutting Pliers, Radio Pliers	1	160 mm	
		⚡ 1000 V	🔧	70 06 160	Diagonal Cutter	1	160 mm	
		⚡ 1000 V	🔪	98 52	Cable Knife	1	185 mm	
		🔧		16 95 01 SB	KNIPEX ErgoStrip®, Universal Stripping Tool	1	135 mm	
		⚡ 1000 V	🔧	98 20 25	Screwdrivers for slotted screws	1	0.4 x 2.5 x 75 mm	
				98 20 35 SL		1	0.6 x 3.5 x 100 mm	
		⚡ 1000 V	🔧	98 20 55 SL	Screwdriver (Slim) for slotted screws	1	1.0 x 5.5 x 115 mm	
				98 20 65 SL		1	1.2 x 6.5 x 150 mm	
		⚡ 1000 V	🔧	98 24 01 SL	Screwdrivers (Slim) for cross-recessed screws, Phillips®	1	PH1 x 80 mm	
				98 24 02 SL		1	PH2 x 100 mm	
		🔧		16 20 165	Dismantling Tool	1	165 mm	
					Voltage detector, single-pole, 247	1	0.5 x 3.0 x 70 mm	
					Mason's Chisels	1	300 x 29 mm	
					Electrician's Chisel	1	250 x 10 mm	
					Locksmith's hammer	1	300 g	
					Chipping hammer	1	800 g	
					Metre ruler (yardstick)	1	2 m	
					Flat brush	1	40 mm	
					Plaster bowl	1	127 x 94 mm	
					PUK® Junior Hacksaw	1	150 x 240 mm	
					Painter's spatula, wood, high quality	1	40 mm	
00 21 02 LE	057499			Tool bag "Classic", empty				2970

Tool bag "Kompakt" Electric

► Equipped with 12 KNIPEX tools, partly VDE-tested according to DIN EN 60900

- > Compact tool bag for the service technician
- > Suitable as an insert for: "Basic" 00 21 05 LE, "BIG Basic Move" 00 21 06 LE, "BIG Twin Move" 00 21 41 LE, "BIG Twin" 00 21 42 LE, "BIG Twin Move RED" 98 99 15 LE and other popular tool cases
- > With 8 tool pouches and 7 tool straps
- > Slip-through back strap to attach to a trolley
- > Made from tough polyester fabric, with zip fastener
- > Bag without tools



00 21 11



00 21 11 LE
Bag without tools

Article No.	EAN				Quantity	Δ g
00 21 11	4003773-084532			Tool Bag "Kompakt" Electric		2975
	026662	MM	12 40 200	Self-Adjusting Insulation Stripper	1	202
	035565	⚡ 1000 V	98 52	Cable Knife	1	67
	028017	MM (PAT. PEND.)	97 53 04	Self-Adjusting Crimping Pliers for wire ferrules with lateral access	1	459
	022022	MM	87 01 250	KNIPEX Cobra® Hightech Water Pump Pliers	1	335
	079767	⚡ 1000 V ⊕	98 24 02 SL	Screwdriver (Slim) for cross-recessed screws Phillips®	1	94
	079774	⚡ 1000 V ⊕	98 25 01 SL	Screwdriver (Slim) for cross-recessed screws Pozidriv®	1	56
	079781	⚡ 1000 V ⊕	98 25 02 SL	Screwdriver (Slim) for cross-recessed screws Pozidriv®	1	90
	079712	⚡ 1000 V ⊖	98 20 35 SL	Screwdriver (Slim) for slotted screws	1	35
	075097	⚡ 1000 V	13 86 200	Pliers for Electrical Installation	1	280
	079927	MM (PAT. PEND.)	16 95 01 SB	KNIPEX ErgoStrip® Universal Stripping Tool	1	75
	021995	⚡ 1000 V	70 06 160	Diagonal Cutter	1	216
	084099	⚡ 1000 V MM	78 06 125	Electronic Super Knips® VDE	1	60
00 21 11 LE	077718			Tool Bag "Kompakt" empty		

Crimp Assortments

for non-insulated wire ferrules

- > In a TANOS MINI-systainer® (solid plastic box)
- > T-Loc fastener for one-handed operation: open or close the systainer® with one turn and connect to a second systainer®
- > Opening when connected: fast and simple access to content without disconnecting
- > Two stackable plastic inserts with 6 trays each for connectors
- > With an assortment of wire ferrules with/without collar

97 90 05

- > With Crimping Pliers for end sleeves 97 71 180; Wire end sleeves without collar

97 90 17

- > With crimping pliers for wire ferrules 97 53 09 and self-adjusting insulation stripper 12 42 195

97 90 23

- > With Crimping Pliers PreciForce® for wire end sleeves 97 52 38

97 90 24

- > With Self-Adapting Universal Insulation Stripper Multistrip 10, 12 42 195; With Self-Adjusting Crimping Pliers for wire end sleeves 97 53 08

97 90 06

- > With Crimping Pliers for end sleeves 97 71 180; Wire end sleeves with collar

97 90 09

- > With Self-Adjusting Crimping Pliers for wire end sleeves 97 53 04

97 90 10

- > With Self-Adjusting Insulation Stripper 12 40 200; With Self-Adjusting Crimping Pliers for wire end sleeves 97 53 04

97 90 12

- > With Self-Adjusting Insulation Stripper 12 40 200; With Self-Adjusting Crimping Pliers for wire end sleeves 97 53 08

97 90 13

- > With KNIPEX Twistor16® 97 53 18 crimping pliers for wire ferrules

97 90 14

- > With crimping pliers for wire ferrules KNIPEX Twistor16® 97 53 18 and automatic insulation stripper KNIPEX PreciStrip16 12 52 195

97 90 15

- > With crimping pliers for wire ferrules 97 53 09 and automatic insulation stripper KNIPEX PreciStrip16 12 52 195

97 90 16

- > With crimping pliers for wire ferrules 97 53 09 and self-adjusting insulation stripper 12 40 200



97 90 05



97 90 10



97 90 13



97 90 23



Several boxes can be connected with each other

Article No.	EAN 4003773-		Pliers	200 x mm ²	150 x mm ²	100 x mm ²	75 x mm ²	50 x mm ²	40 x mm ²	± g
97 90 05	025535		97 71 180	0,5 / 0,75 / 1 / 1,5 / 2,5	4 / 6			10 / 16		930
97 90 06	025542		97 71 180	0,5 / 0,75 / 1 / 1,5	2,5		6	10	16	1000
97 90 09	028574		97 53 04	0,5 / 0,75 / 1 / 1,5 / 2,5		4 / 6		10		1420
97 90 10	046202		12 40 200 97 53 04	0,5 / 0,75 / 1 / 1,5 / 2,5		4 / 6		10		1353
97 90 12	048916		12 40 200 97 53 08	0,5 / 0,75 / 1 / 1,5 / 2,5		4 / 6		10		1427
97 90 13	083474		97 53 18	0,5 / 0,75 / 1 / 1,5	2,5		6	10	16	1270
97 90 14	084884		97 53 18 12 52 195	0,5 / 0,75 / 1 / 1,5	2,5		6	10	16	1450
97 90 15	084877		97 53 09 12 52 195			1,5 / 2,5		6	4	1450
97 90 16	086024		12 40 200 97 53 09	0,5 / 0,75 / 1 / 1,5 / 2,5		4 / 6		10		1450
97 90 17	086031		97 53 09	0,5 / 0,75 / 1 / 1,5 / 2,5		4 / 6		10		1450
97 90 23	062158		97 52 38	0,5 / 0,75 / 1 / 1,5 / 2,5		4 / 6				1226
97 90 24	062394		97 53 08	0,5 / 0,75 / 1 / 1,5 / 2,5		4 / 6		10		1348
97 90 00 LE	054009	TANOS MINI-systainer® empty								900

Crimp Assortments

for cable connectors

- > In a TANOS MINI-systainer® (solid plastic box)
- > T-Loc fastener for one-handed operation: open or close the systainer® with one turn and connect to a second systainer®
- > Opening when connected: fast and simple access to content without disconnecting
- > Two stackable plastic inserts with 6 trays each for connectors
- > With an assortment of standard cable connectors

97 90 21

- > With Crimping Pliers KNIPEX PreciForce® 97 52 36 (for insulated terminals and plug connectors)

97 90 22

- > With Self-Adapting Universal Insulation Stripper KNIPEX Multi-strip 10, 12 42 195; with Crimping Pliers KNIPEX PreciForce® 97 52 36 (for insulated terminals and plug connectors)

97 90 25

- > With crimping pliers 97 22 240

97 90 26

- > With crimping pliers 97 32 240



97 90 21



97 90 22



97 90 25



97 90 26





Article No.	EAN	Zangen	Cable Connectors		g		
			Quantity	Cable mm ²			
97 90 21	062134	97 52 36		Blade Terminal Sockets, 6.3 x 0.8 mm	25	0,5 - 1	1416
					25	1,5 - 2,5	
					25	0,5 - 1	
				Round Sockets, Ø 4 mm	25	0,5 - 1	
				Cable Connectors, eye type, Ø 4 mm	25	4 - 6	
					25	4 - 6	
				Cable Connectors, eye type, Ø 5 mm	25	1,5 - 2,5	
					25	1,5 - 2,5	
				Cable Connectors, eye type, Ø 6 mm	25	1,5 - 2,5	
				Butt Connectors, insulated, red	25	0,5 - 1	
				Butt Connectors, insulated, blue	25	4 - 6	
				Round Pin Plugs, Ø 4 mm	25	1,5 - 2,5	
97 90 22	062141	97 52 36 12 42 195		Blade Terminal Sockets, 6.3 x 0.8 mm	25	0,5 - 1	1527
					25	1,5 - 2,5	
				Cable Connectors, eye type, Ø 4 mm	25	0,5 - 1	
				Cable Connectors, eye type, Ø 5 mm	25	0,5 - 1	
				Cable Connectors, eye type, Ø 6 mm	25	1,5 - 2,5	
				Cable Connectors, eye type, Ø 8 mm	25	1,5 - 2,5	
				Cable Connectors, eye type, Ø 4 mm	25	1,5 - 2,5	
				Cable Connectors, eye type, Ø 5 mm	25	4 - 6	
				Cable Connectors, eye type, Ø 6 mm	25	4 - 6	
				Butt Connectors, insulated, red	25	0,5 - 1	
				Butt Connectors, insulated, blue	25	1,5 - 2,5	
				Butt Connectors, insulated, yellow	25	4 - 6	
97 90 25	076971	97 22 240		Blade Terminal Sockets, 6.3 x 0.8 mm	25	0,5 - 1,5	1150
					25	1 - 2,5	
				Cable Connectors, eye type, Ø 4 mm	25	0,5 - 1	
				Cable Connectors, eye type, Ø 5 mm	25	1,5 - 2,5	
				Cable Connectors, eye type, Ø 4 mm	25	4 - 6	
				Cable Connectors, eye type, Ø 5 mm	25	0,5 - 1	
				Cable Connectors, eye type, Ø 6 mm	25	1,5 - 2,5	
					25	0,5 - 1	
				Cable Connectors, eye type, Ø 8 mm	25	1,5 - 2,5	
				Butt Connectors, insulated, red	25	0,5 - 1	
				Butt Connectors, insulated, blue	25	1,5 - 2,5	
				Butt Connectors, insulated, yellow	25	4 - 6	
97 90 26	079521	97 32 240		Non-insulated Blade Terminal Sockets 6.3 x 0.8 mm	25	1,5 - 2,5	1420
					25	4 - 6	
				Blade Terminal Sockets 6.3 x 0.8 mm	25	0,5 - 1	
					25	0,5 - 1	
				Blade Terminal Plugs 6.3 x 0.8 mm	25	1,5 - 2,5	
					25	4 - 6	
				Cable Connectors, eye type Ø 4 mm	25	4 - 6	
					25	0,5 - 1	
				Butt Connectors, insulated, red	25	1,5 - 2,5	
				Butt Connectors, insulated, blue	25	0,5 - 1	
				Butt Connectors, insulated, yellow	25	0,5 - 1	
				97 90 00 LE	054009	TANOS MINI-systainer® empty	

Tool Case for Photovoltaics

- > With tools for photovoltaics
- > Without crimping dies – please order separately (see ref. 97 49...) for individual assortment
- > With service tools (hexagonal key) for the change of crimping dies
- > Shock-resistant plastic case
- > Foam insert with recesses for tools, crimping dies and locators
- > Dimensions, exterior (W x H x D): 345 x 80 x 280 mm



97 91 01

Article No.	EAN			Quantity	g
97 91 01	4003773-070351		Tool Case for Photovoltaics	1	1964
		MM	12 12 11 Precision Insulation Stripper, with adapted blades	1	
		1000V    	95 16 165 Cable Shears	1	
		MM	97 43 200 Crimp System Pliers, for exchangeable crimping dies	1	



Compact Tool Case

17 parts

► With insulated tools for works on electrical installations

- > Shock-resistant plastic case
- > Foam insert with precise recesses for holding the pliers
- > Equipped with a range of customary insulated KNIPLEX tools for work on electrical systems
- > All tools are tested one by one and meet the requirements of ASTM F1505 and IEC 60900
- > Dimensions, exterior (W x H x D): 380 x 85 x 260 mm
- > DIN EN 60900, IEC 60900



98 99 11

Article No.	EAN 4003773- 026624				Quantity	g ⚖
98 99 11			Compact Tool Case 17 parts			3675
		⚠ 1000 V ⚡ ⚠	03 07 200	Combination Pliers	1	
		⚠ 1000 V ⚡ ⚠	70 07 160	Diagonal Cutter	1	
			98 20 35		1	
		⚠ 1000 V ⚡ ⚠	98 20 40	Screwdrivers for slotted screws	1	
			98 20 55		1	
		⚠ 1000 V ⚡ ⚠	98 24 00	Screwdriver for cross recessed screws, Phillips®	1	
		⚠ 1000 V ⚡	98 42	Reversible Ratchet, with driving square 1/2"	1	
		⚠ 1000 V ⚡	98 45 125	Extension Bar, with internal/external square 1/2"	1	
			98 45 250		1	
			98 47 10		1	
			98 47 11		1	
			98 47 12		1	
		⚠ 1000 V ⚡	98 47 13	Hexagon Socket for hexagonal screws, with internal square 1/2"	1	
			98 47 14		1	
			98 47 17		1	
			98 47 19		1	
		⚠ 1000 V ⚡ ⚠	98 52	Cable Knife	1	

Compact Tool Case

26 parts

► With insulated tools for works on electrical installations

- > Shock-resistant plastic case
- > Foam insert with precise recesses for holding the pliers
- > Equipped with a range of customary insulated KNIPEX tools for work on electrical systems
- > Fixable partition wall
- > Dimensions, exterior (W x H x D): 440 x 105 x 385 mm



98 99 12

Article No.	EAN 4003773-				Quantity	g
98 99 12	026631			Standard Tool Case 26 parts		5533
		⚠ 1000V	03 07 200	Combination Pliers	1	
		⚠ 1000V	70 07 160	Diagonal Cutter	1	
			98 00 10	Open End Wrench	1	
			98 00 11		1	
			98 00 12		1	
		⚠ 1000V	98 00 13		1	
			98 00 14		1	
			98 00 17		1	
			98 00 19	1		
		⚠ 1000V	98 53 03	Dismantling Knife for round cables	1	
			98 20 25	Screwdrivers for slotted screws	1	
		⚠ 1000V	98 20 35		1	
			98 20 40		1	
			98 20 55		1	
			98 24 00	Screwdriver for cross recessed screws,Phillips®	1	
		⚠ 1000V	98 24 01		1	
			98 24 02	1		
		⚠ 1000V	98 40	T-Handle Drive, with driving square 1/2"	1	
			98 47 10	Hexagon Socket for hexagonal screws, with internal square 1/2"	1	
			98 47 11		1	
			98 47 12		1	
		⚠ 1000V	98 47 13		1	
			98 47 14		1	
			98 47 17		1	
			98 47 19	1		
		⚠ 1000V	98 52	Cable Knife	1	

Tool bag "Stretched"

Handy, but roomy: the tool bag for long tools

- > Made of hard-wearing polyester fabric
- > For tools up to 450 mm in length
- > With two compartments on the back
- > With carrying handle and adjustable shoulder strap
- > Closing strap made of leather
- > Bag without tools



00 21 07 LE

Article No.	EAN 4003773-	Dimension exterior (interior) width mm	Dimension exterior (interior) height mm	Dimension exterior (interior) depth mm	g
00 21 07 LE	071358	550 (530)	225 (190)	190 (160)	1760

Tool bag "LightPack"

Lightweight and durable, securely locked but quick to open: good for the service vehicle, good for the boot

- > Can be opened from both sides
- > Made from tough polyester fabric, with zip fasteners and hook-and-loop fastener
- > Tool loops inside
- > Plastic base tray
- > Steel handle with softgrip
- > Shoulder strap (can also be used as tool belt)
- > Max. payload: 20 kg
- > Bag without tools



00 21 08 LE



Article No.	EAN 4003773-	Dimension exterior (interior) width mm	Dimension exterior (interior) height mm	Dimension exterior (interior) depth mm	g
00 21 08 LE	077787	480 (450)	380 (310)	300 (260)	2800

Tool bag "Service"

Everything you need: store your tools and notebook safely

- > Lined inside pouch for notebook and DIN A4 documents; also with DIN A4 zipped compartment
- > 90° fold-out front pouch with 8 tool pouches and one small inside pouch
- > Reverse side of the front pouch with 5 tool pouches and 3 pen pouches
- > Removable tool board with 8 tool pouches on the front and 2 rows of elastic loops on the back
- > Splash-water-protected bottom
- > Adjustable shoulder belt with quick-release fastener
- > With two carry loops
- > Made of hard-wearing polyester fabric
- > Bag without tools



00 21 10 LE

Article No.	EAN 4003773-	Dimension exterior (interior) width mm	Dimension exterior (interior) height mm	Dimension exterior (interior) depth mm	g
00 21 10 LE	074472	460 (410)	310 (300)	240	2700

Tool bag "Kompakt"

Everything organised: tools well stored

► Compact tool bag for the service technician

- > Suitable as an insert for: "Basic" 00 21 05 LE, "BIG Basic Move" 00 21 06 LE, "BIG Twin Move" 00 21 41 LE, "BIG Twin" 00 21 42 LE, "BIG Twin Move RED" 98 99 15 LE and other popular tool cases
- > With 8 tool pouches and 7 tool straps
- > Slip-through back strap to attach to a trolley
- > Made from tough polyester fabric, with zip fastener
- > Bag without tools



00 21 11 LE

Article No.	EAN 4003773-	Dimension exterior (interior) width mm	Dimension exterior (interior) height mm	Dimension exterior (interior) depth mm	g
00 21 11 LE	077718	410 (380)	300 (280/280)	80 (65)	450

Tool Roll

empty

- > Tool roll made of hard-wearing polyester fabric
- > With practical, adjustable quick release fastener
- > Dimensions, open (L x H): 450 x 290 mm



Article No.	EAN	⚖️
00 19 41 LE	4003773- 035930	g 155

Tool Roll

empty

- > Tool roll made of hard-wearing polyester fabric
- > With practical, adjustable quick release fastener
- > Dimensions, open (L x H): 830 x 310 mm



Article No.	EAN	⚖️
98 99 13 LE	4003773- 028888	g 500

Belt Pouch

For two pliers: well stored and close at hand

- > For two pliers up to 160 mm in length
- > Made of hard-wearing polyester fabric
- > With hook-and-loop fastener
- > With elastic side holder for small flash lamp, pen or suchlike
- > With practical belt clip
- > Bag without tools



00 19 72 LE



Practical clip for attaching to belt or trousers



For better accessibility, the clip can be fixed on the inside with the hook-and-loop fastener



Article No.	EAN 4003773-	Width mm	Height mm	Depth mm	⚖️ g
00 19 72 LE	070191	75	180	55	65

Belt Tool Pouch

**The most important tools straight to you:
The tool bag for your belt**

- > Made of hard-wearing polyester fabric and leather
- > With pockets for up to 8 tools
- > Tool loops made of leather, riveted
- > With snap hook
- > Bag without tools



00 19 73 LE

Article No.	EAN 4003773-	Width mm	Height mm	Depth mm	⚖️ g
00 19 73 LE	072065	170	235	75	210

98 20 40	223	98 53 03	230
98 20 40 SL	223	98 53 13	230
98 20 55	223	98 54	230
98 20 55 SL	223	98 55	230
98 20 65	223	98 56	231
98 20 65 SL	223	98 56 09	231
98 20 80	223	98 62 01	231
98 21 45	223	98 62 02	231
98 24 00	223	98 64 02	232
98 24 01	223	98 65 01	232
98 24 01 SL	224	98 65 02	232
98 24 01 SLS	224	98 65 03	232
98 24 02	223	98 65 40	232
98 24 02 SL	224	98 65 41	232
98 24 02 SLS	224	98 65 42	232
98 24 03	223	98 66 10	232
98 24 04	223	98 66 20	232
98 25 00	224	98 66 30	232
98 25 01	224	98 66 40	232
98 25 01 SL	225	98 66 45	232
98 25 02	224	98 66 50	232
98 25 02 SL	225	98 66 60	232
98 25 03	224	98 67 05	233
98 25 04	224	98 67 10	233
98 26 10	225	98 67 15	233
98 26 15	225	98 67 20	233
98 26 20	225	98 67 25	233
98 26 25	225	98 90	233
98 26 30	225	98 90 01	233
98 29 25	226	98 99 11	234
98 29 27	226	98 99 11	324
98 29 30	226	98 99 12	235
98 29 40	226	98 99 12	325
98 29 45	226	98 99 13	237
98 29 50	226	98 99 13	270
98 30	226	98 99 13 LE	237
98 31	226	98 99 13 LE	270
98 33 25	229	98 99 13 LE	328
98 33 50	229	98 99 15	301
98 35 125	227	98 99 15 LE	301
98 35 250	227	99 00 200	76
98 37 1/2"	228	99 00 220	76
98 37 10	227	99 00 220 K12	76
98 37 11	227	99 00 250	76
98 37 12	227	99 00 280	76
98 37 13	227	99 00 300	76
98 37 14	227	99 01 200	76
98 37 16	227	99 01 220	76
98 37 17	227	99 01 250	76
98 37 19	227	99 01 280	76
98 37 3/4"	228	99 01 300	76
98 37 3/8"	228	99 04 220	76
98 37 5/16"	228	99 04 250	76
98 37 5/8"	228	99 04 280	76
98 37 7/16"	228	99 10 250	77
98 37 9/16"	228	99 10 300	77
98 39 05	228	99 11 250	77
98 39 06	228	99 11 300	77
98 39 08	228	99 14 250	77
98 40	226	99 14 300	77
98 41	226		
98 42	229		
98 43 50	229		
98 45 125	227		
98 45 250	227		
98 47 1"	228		
98 47 1/2"	228		
98 47 10	227		
98 47 11	227		
98 47 11/16"	228		
98 47 12	227		
98 47 13	227		
98 47 14	227		
98 47 16	227		
98 47 17	227		
98 47 18	227		
98 47 19	227		
98 47 22	227		
98 47 24	227		
98 47 27	227		
98 47 3/4"	228		
98 47 5/8"	228		
98 47 7/8"	228		
98 47 9/16"	228		
98 49 05	228		
98 49 06	228		
98 49 08	228		
98 52	230		

12-Point Sockets	228	Electronics End Cutting Nippers	250
ACSR Cable Cutter (ratchet action)	155	Electronics Mounting Pliers	255
Adjustable Wrench	220	Electronics Oblique Cutting Nipper	251
Anvil shears	129	Electronics Pliers / ESD	253, 254
Assortment Boxes	192	Electronics Pliers Sets	256
Automatic Insulation Stripper	26, 30	Electronics Wire Stripper	21
Automatic Insulation Stripper for flat cable	31	Electronics Wire Stripping Shears	21
Automatic Stripping Pliers	31	End Cutting Nippers	75, 101
Belt Pouch	329	End Cutting Nippers for mechanics	101
Belt Tool Pouch	329	Extension Bars	227
Blade Terminal Plugs	188	Extension sets Electro	279
Blade Terminal Sockets	188	F-compression connector	193
Bolt Cutters	97	Farriers' Pincers	75
Bolt End Cutting Nippers	99	Flat Nose Grozing Pliers	141
Bowden Cable Cutter	160	Flat Nose Pliers	46, 205
Box Wrenches	220	Flat Nose Pliers with cutting edges	14
Brick Pincers	75	Flat Pin Accessory Distributors	188
Butt Connectors	189, 190	Folding Knife for Electricians	37
Cable Connectors, eye type	189	Four-Mandrel Crimping Pliers for turned contacts	178
Cable Cutters (ratchet action / SWA cable)	158, 216	Glass Breaking Pincer	141
Cable Cutters (ratchet action)	156, 215	Glass Nibbling Pincers	141
Cable Cutters (ratchet principle, 3-stage)	157, 216	Grip Pliers	55
Cable Knives	230, 231	Gripping Pliers	49
Cable Shears	150, 153, 212, 213, 214	Gripping Pliers for precision mechanics	52
Cable Shears (ratchet action)	159	Halogen Bulb Exchange Pliers	142
Cable Shears for two-hand operation	154	Hammerhead Style Carpenters' Pincers	74
Cable Shears with twin cutting edge	151, 213	Hexagon Sockets for hexagonal socket screws	227, 228
Cable tie cutting set	275	High Leverage Centre Cutters	91
Carpenters' Pincers	74	High Leverage Combination Pliers	5, 198
Case for Electronics Pliers	276	High Leverage Concreters' Nippers	77
Circlip Pliers for external circlips on shafts	59	High Leverage Diagonal Cutters	88, 209
Circlip Pliers for grip rings on shafts	66	High Leverage End Cutting Nippers	99
Circlip Pliers for internal circlips in bore holes	58	High Leverage Flush Cutter for soft metal and plastic	81
Circlip Pliers for large external circlips	64	High Performance Diagonal Cutters	90
Circlip Pliers for large internal circlips	64	Hose Clamp Pliers for Click clamps	138
Circlip Tool for internal and external circlips	65	Insertion tool for LSA-Plus and identical construction design	165
Combination Pliers	4, 8, 198, 199	Insulating clamps	232
Combination Shears	133	Insulating Mats from rubber	233
Compact Diagonal Cutters	87, 209	Insulation Strippers	20, 25, 36, 200
Compact Tool Case	234, 235, 324, 325	Insulation strippers with cable shears	35
Compression Tool for coax connectors	173	Jewellers' Pliers	13
Concrete Mesh Cutter	98	KNIPEX Alligator® - Water Pump Pliers	116
Concreters' Nippers	76	KNIPEX Alligator® - Water Pump Pliers	210
Control Cabinet Key "DoubleJoint"	145	KNIPEX Alligator® XL - Water Pump Pliers	118
Control Cabinet Keys	143	KNIPEX CoBolt® - Compact Bolt Cutters	94
Corrugated pipe cutters	127	KNIPEX CoBolt® S - Compact Bolt Cutters	93
Crimp Assortments	186, 187, 320, 321	KNIPEX CoBolt® XL - Compact Bolt Cutters	96
Crimp System Pliers for exchangeable crimping dies	168	KNIPEX Cobra® - Hightech Water Pump Pliers	110
Crimping Dies	170	KNIPEX Cobra® ES - Water Pump Pliers extra-slim	115
Crimping Pliers	164	KNIPEX Cobra® QuickSet - Hightech Water Pump Pliers	114
Crimping Pliers also for two-hand operation	175	KNIPEX Cobra® Set - Hightech Water Pump Pliers	113, 271
Crimping Pliers for micro plugs	183	KNIPEX Cobra® VDE - Hightech Water Pump Pliers	115, 211
Crimping Pliers for Scotchlok™ connectors	173	KNIPEX Cobra® XL / XXL - Hightech Water Pump Pliers	112
Crimping Pliers for Western plugs	174	KNIPEX Cobra® XS - Hightech Water Pump Pliers	109
Crimping Pliers for wire ferrules	183, 185, 218	KNIPEX Cobra®...matic - Water Pump Pliers	113
Crimping Pliers for wire ferrules with mandrel crimp	184	KNIPEX eCrimp - Electromechanical Crimp System Pliers	169
Crimping Pliers short design	174	KNIPEX ErgoStrip® - Universal Stripping Tool	43
Cross-Over Tweezers	260	KNIPEX L-BOXX® - Tool Case	315
Cutter for ribbon cable	131	KNIPEX L-BOXX® Electro - Tool Case	316
Cutters	161	KNIPEX L-BOXX® Sanitary - Tool Case	317
Cycle Pliers	136	KNIPEX MultiCrimp® - Crimping Pliers with changer magazine	166
Depth Stripping Tool	41	KNIPEX MultiStrip 10 - Automatic Insulation Stripper	26
Diagonal Cutters	84, 208	KNIPEX PlastiCut® - Cutter for flexible hoses and plastic	129
Diagonal Cutters for electromechanics	86	KNIPEX PreciForce® - Crimping Pliers	176
Diagonal Cutters for fibre optics	81	KNIPEX PreciStrip16 - Automatic Insulation Stripper	29
Diagonal Cutters for plastics	80	KNIPEX SmartGrip® - Water Pump Pliers	108
Diagonal Insulation Strippers	23, 203	KNIPEX StepCut	149
Duckbill Pliers	51	KNIPEX StriX® - Insulation strippers with cable shears	35, 201
Ear Clamp Pliers	126	KNIPEX TubiX® - Pipe Cutter	128
Electricians' Gloves	232	KNIPEX TwinForce® - High Performance Diagonal Cutters	90
Electricians' Pliers	12	KNIPEX TwinKey® - Control Cabinet Key	143
Electricians' Shears	153	KNIPEX TwistCut® - Corrugated pipe cutters	127
Electronic Super Knips®	240	KNIPEX Twistor16® - Self-Adjusting Crimping Pliers for wire ferrules	181
Electronic Super Knips® XL	242	KNIPEX X-Cut® - Compact Diagonal Cutters	87, 209
Electronic Super Knips® XL ESD	243	Lineman's Pliers, American style	9
Electronics Diagonal Cutters / ESD	246, 247, 248, 249	Long Nose Pliers	50, 207

Long Reach Needle-Nose Pliers	48	Stand Mats from rubber	233
Long Reach Needle-Nose Pliers with transverse profiles.....	48	Stork Beak Pliers	16, 206
Long Reach Needle-Nose Pliers with wave profile	48	Stripping Knives	230
Magnetic LED Lamp	142	Stripping Pliers	34, 203
Material catcher.....	142	Stripping Tool for coax cables	38, 39
Mechanics' Pliers.....	53	Stripping Tool for data cables.....	40
Mini Combination Pliers	8	Stripping Tool for fibre optics	33
Mini pliers sets	274, 275	Stripping Tool for flat and round cables.....	40
Mini Water Pump Pliers with groove joint.....	119	Stripping Tools	38
Mini Wire Stripper	32	Stripping Tools for spiral cutting	37
Mitre Shears for plastic and rubber sections	131	Stripping Tools with scalpel blade	36
Multifunctional – cutting and stripping with one pair of pliers	34	Stripping Tweezers for coated wire.....	33
Multiple Slip Joint Spanner	108	T-handle.....	226
Needle-Nose Combination Pliers.....	6, 200	Tear-off Pliers for vehicle bodywork.....	75
Needle-Nose Pliers	49	Telephone Pliers	14, 49
Non-insulated Solderless Terminals	189	Tethered Tools	266
Non-insulated wire ferrules.....	191	Tile Breaking Pliers	140
Notching Pliers.....	136	Tile Nibbling Pincer.....	139
Nut Drivers.....	221	Tool bag "Classic" Electro	318
Open-end wrenches	219	Tool bag "Kompakt"	327
Parrot Beak Pincer.....	139	Tool bag "Kompakt" Electric	319
Pen-Style Control Cabinet Key.....	145	Tool bag "LightPack"	326
Pipe Cutter for composite and plastic pipes.....	134	Tool bag "Service"	327
Pipe Cutter for composite pipes and protective tubes	133	Tool bag "Stretched"	326
Pipe Cutter for plastic conduit pipes.....	134	Tool Box "RED" Electro	236, 284
Pipe cutters for multilayer and pneumatic hoses.....	130	Tool Box "SRZ" Precision Circlip Pliers	71, 285
Pipe cutters for plastic	130	Tool Case "Basic"	287
Pipe Wrenches 45°	120	Tool Case "BIG Basic Move"	289
Pipe Wrenches 90°	120	Tool Case "BIG Basic Move" Electro	290
Pipe Wrenches S-Type.....	121	Tool Case "BIG Basic Move" Sanitary	293
Plastic Flat Nose Pliers.....	231	Tool Case "BIG Twin Move Red"	300
Plastic Slip-On Caps	232	Tool Case "BIG Twin Move"	296
Plastic Snipe Nose Pliers	231	Tool Case "BIG Twin Move" Electro	297
Pliers for Electrical Installation	10, 204	Tool Case "BIG Twin" Electro	299
Pliers Sets	69, 277, 283	Tool Case "BIG Twin"	298
Pliers Wrench - Protective jaws	107	Tool Case "Focus" Electro	314
Pliers Wrench with roughened jaws	107	Tool Case "Robust"	303
Pliers Wrench XL	106	Tool Case "Robust23" Electro	304
Pliers Wrenches	104, 210	Tool Case "Robust34" Electro	306
Plug Connectors.....	188	Tool Case "Robust45 Move" Electro	308
Potters' Pincers	75	Tool Case "Robust45 Move" Mechanics	310
Precision Circlip Pliers for external circlips on shafts	62	Tool Case "Vision24" Electro.....	312
Precision Circlip Pliers for internal circlips in bore holes	60	Tool Case "Vision27" Sanitary.....	313
Precision Circlip Pliers Set	70, 278	Tool Case "BIG Basic Move" Electro Plus.....	291
Precision Electronics Diagonal Cutters / ESD.....	244, 245	Tool Case "BIG Basic Move" Mechanics	292
Precision Electronics Gripping Pliers	252	Tool Case for Photovoltaics.....	172, 322
Precision Insulation Strippers	24	Tool Kits	280, 282
Precision Mechanics Pliers	14	Tool Roll	237, 270, 328
Precision Tweezers.....	212, 257, 258, 259, 260, 261	Torque Wrenches.....	229
Profi-Key	144	Tower Pincers, Steel Fixers' Nippers.....	76
PUK® Junior Hacksaw.....	233	Twin wire ferrules with plastic collar	191
Punch Lock Riveters.....	135	Universal Grip Pliers	54
Radio Pliers	15, 205	Universal Key	144
Relay Adjusting Pliers	51	Universal Key "Construction"	144
Reversible Ratchets	226, 229	Universal Stripping Tool for building and industrial cables.....	42
Revolving Punch Pliers.....	139	Universal Stripping Tools.....	41, 43
Ring Pliers for retaining rings on shafts.....	66	Upholstery Pliers	140
Round Nose Pliers	47, 204	Vinyl Shears	132
Round Pin Plugs.....	189	Water Pump Pliers.....	118
Round Pliers with cutting edge	13	Water Pump Pliers with groove joint	119
Round Sockets	188	Welding Grip Pliers.....	54
Screwdrivers.....	222, 223, 224, 225	Wire ferrules with plastic collar	190
Self-Adjusting Crimping Pliers for wire ferrules	180, 181, 182	Wire Rope and ACSR-Cable Cutters	160, 217
Self-Adjusting Insulation Strippers	27	Wire Rope Cutters	152, 160
Self-Clamping Slip-On Caps	232	Wire Stripper for fibre optics	32
Set of Circlip Pliers	67, 68, 70, 272, 273, 278	Wire Stripping Tool for coax and data cable	39
Set of Mounting Tools for solar cable connectors MC4 (Multi-Contact)	173		
Set of Pliers Wrenches	106, 271		
Shears for KEVLAR® fibres	132		
Sheet Metal Nibbler	135		
Siphon and Connector Pliers.....	123		
Small High Leverage Combination Pliers with pointed jaw.....	6		
Snipe Nose Pliers with centre cutter	14		
Snipe Nose Side Cutting Pliers	15, 16, 205, 206		
Sockets with Torx drive	226		
Spring Hose Clamp Pliers.....	137		

It is not permissible to copy the catalogue or parts of it in any way without our approval.

Illustrations, dimensions and weights are just approximate. No liability is assumed for misprints or errors.

Printed in the Federal Republic of Germany.

KNIPEX-Werk C. Gustav Putsch KG 2020



- 1 Point
- 2 Gripping surface
- 3 Recess (pipe grip)
- 4 Additional cutting edge
- 5 Jaw
- 6 Flank

Direction and position of the cutting edges

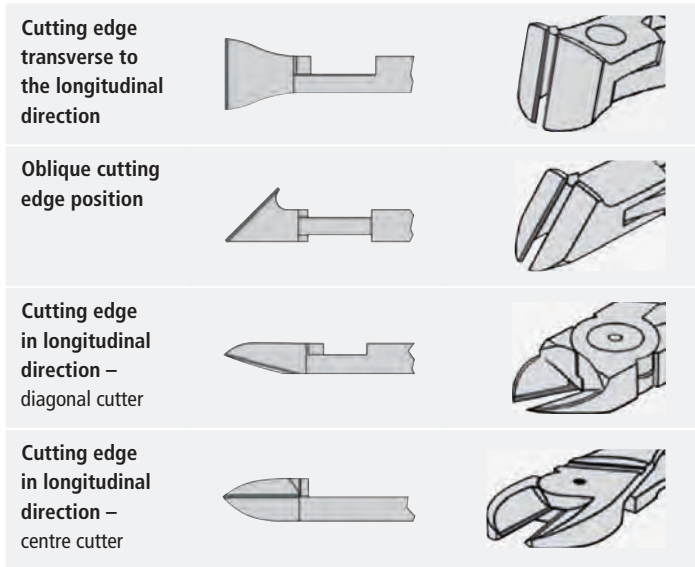

Cutting edge shapes DIN ISO 5742

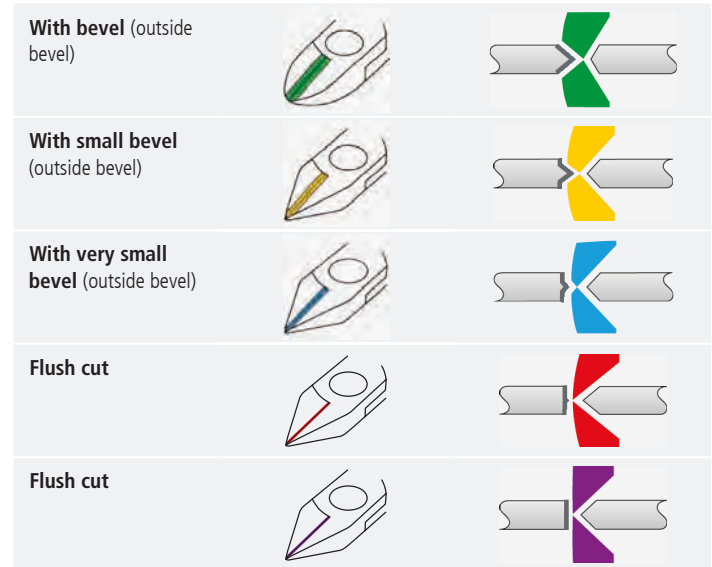

Joint types

<p>Lap joint</p> <p>With the lap joint, which is used on carpenters' pincers, concretors' nippers and high leverage diagonal cutters, the two halves of the pliers lie on top of each other without being milled out. The pliers handle can thus be designed to be very robust.</p>	
<p>Single joint</p> <p>With the single joint, half the thickness of each pliers handle is milled. Both pliers handles can thus be fitted into one another. The outer sides in the rivet area are smooth and not indented.</p>	
<p>Box joint</p> <p>One handle on the pliers is slit. The other handle is pushed through this slot. This joint connection can withstand a high level of load and strain because the joint bolt is supported on both sides and the inside handle is guided on both sides.</p>	
<p>Slip joint</p> <p>Slip joints enable optimal adaptation of the gripping jaws of pliers to various workpiece sizes. The opening width of the jaws is increased or decreased for this purpose. This occurs through shifting the two pliers handles with respect to one another.</p>	

Safety instruction

- > Each tool should only be used for its specified purpose.
- > When using cutting pliers: beware of wire ends flying off. Wear protective goggles and – if needed – gloves. Be aware of bystanders!
- > Only handles marked with the symbol 1000 V are insulating.



Care instructions

A drop of oil (e.g. WD-40®) on the polished surfaces and in the joint keeps your pliers in good working order and extends their service life!



Basic jaw shapes

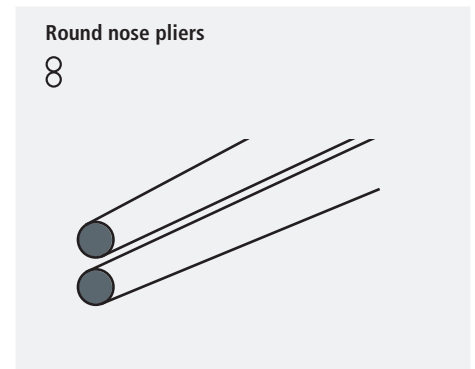
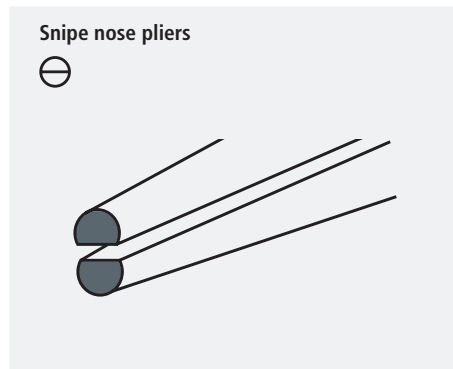
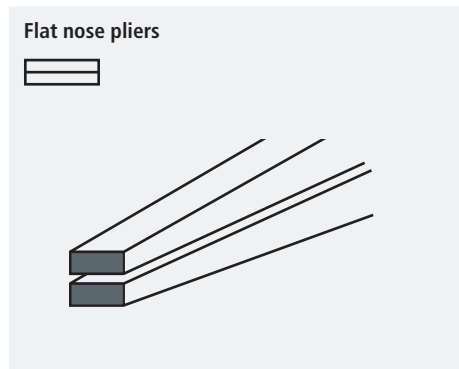

Examples of different handle types on a pair of pliers



Straight handles, fully-metal design without plastic grips are used when the hand must be placed at various positions when gripping. This is often the case with carpenters' pliers and concretors' nippers.



S-shaped handles, thin plastic coatings render pliers slip resistant and pleasant to grip. They support a precise hand position, which can be useful in screwing motions, for example. The typical handle for water pump pliers.



Curved handles, thin plastic coatings support the hand at the front and rear. This is always beneficial where high forces are required, for example with diagonal cutters.



Multi-component grips
Compared to handles with a thin plastic coating, comfort handles offer the hand a larger contact surface, enabling better distribution of force and thus making work more comfortable.



VDE*-insulated handles, multi-component grips
Insulated grips for working on electrical systems. Approved to DIN EN/IEC 60900, these pliers comply with significantly more stringent technical and safety standards.







VDE*-insulated handles with dip-insulation
The dipped VDE-handles guarantee the same electrical protection as other VDE insulated handles. In particular, energy companies use these different looking VDE-pliers to help prevent the wrong tool from being used.







ESD-grips, multi-component grips**
Dissipative sleeves enable a gradual, controlled equalisation of any prevailing differences in electric potential between the operator and sensitive electronic components.









* Association for Electrical, Electronic and Information Technologies
** electrostatic discharge

Cutting value table

Article No.	Length	 Ø mm	 Ø mm	 Ø mm	 Ø mm	Page
020	180			2,5	2,0	5, 198
	200			2,8	2,2	5, 198
	225			3,0	2,5	5, 198
030	140		2,8	1,8		4, 199
	160		3,1	2,0		4, 199
	180		3,4	2,2		4, 199
	200		3,8	2,5		4, 199
	250		3,8	2,5		4, 199
08 0	110		2,5	1,6		8
08 2	145		3,0	2,0		6, 200
09 01/02/11/12	240		4,6	3,0		9
13 0	160		2,5	1,6		12
13 4	165		3,2	2,2		34, 203
19 0	130		2,2	1,6		13
23 01	140	2,5	1,6			14
25 01/03	125		2,2	1,6		15
25 0/21/25/26	140		2,5	1,6		15
	160		2,5	1,6		15, 205
26 1/26 2	200		3,2	2,2		16, 206
50 0	160		1,8			74
	180		2,0			74
	210		2,2			74
	225		2,2			74
	250		2,2			74
	300		2,4			74
51 01	210		1,8			74
55 00 300	300	2,0 - 3,0				75
58 30 225	225	2,0				75
61 0	200	1,0 - 6,0	4,0	3,5	3,0	99
62 12	120	0,3 - 1,0	0,7			251
64 0	115	2,0	1,0	0,6		251
64 11	115	1,4	0,8			251
64 12	115	2,0	0,8	0,5		251
64 22	115	0,8				251
64 32	120	1,5	1,0	0,5		251
64 42	115	1,5	1,0	0,5		251
64 52	115	1,3				251
64 62	120	0,6				251
64 72	120	1,5				251
67 0	140	4,0	3,1	2,0	1,5	99
	160	4,5	3,4	2,5	2,0	99
	200	5,0	3,8	3,0	2,5	99
68 01	160	4,0	2,8	2,3		101
	180	4,0	3,2	2,5		101
	200	4,0	3,5	2,8		101
	280	4,5	4,0	3,2		101
69 0	130	0,4 - 2,0	1,3	1,0	0,8	101
70	110	3,0	2,0	1,2		85
	125	3,0	2,3	1,5		85, 208
	140	4,0	2,5	1,8		85, 208
	160	4,0	3,0	2,0		85, 208
	180	4,0	3,0	2,5		85, 208
71	160	5,3	4,4	3,2	3,0	93
	200	6,0	5,2	4,0	3,6	94, 95

Article No.	Length	 Ø mm	 Ø mm	 Ø mm	 Ø mm	Page
73 0	160	4,8	3,8	2,7	2,2	87, 209
73 7	180	5,5	4,6	3,2	3,0	90
74 0	140		3,1	2,0	1,5	89
	160		3,4	2,5	2,0	89, 209
	180		3,8	2,7	2,2	89, 209
	200		4,2	3,0	2,5	89, 209
	250		4,6	3,5	3,0	89, 209
74 91	250	5,0	5,0	3,8	3,5	91
75 02	125	0,2 - 1,3	1,0	0,6	0,4	246
75 12	125	0,2 - 1,3	1,0	0,6	0,4	246
75 22	125	0,2 - 1,3	0,9	0,4	0,3	246
75 52	125	0,2 - 0,8	0,5	0,3		246
76 01/03/05/12	125	0,4 - 3,0	2,3	1,5	0,6	86
76 22	125	0,4 - 2,5				86
76 81	125	0,4 - 1,7	1,3	0,8		86
77 01/02	115	0,3 - 1,6	1,2	0,6		247
	130	0,3 - 2,0	1,5	0,8		247
77 11/12	115	0,3 - 1,6	1,2	0,6		247
77 21	115	0,3 - 1,3	1,0			247
	130	0,3 - 1,6	1,3			247
77 22	115	0,3 - 1,3	1,0			247
	130	0,3 - 2,0	1,5			247
77 32	115	0,3 - 1,3	1,0	0,5		247
77 41	115	1,3	0,8			247
77 42	115	0,3 - 1,3	0,8			247
	130	0,3 - 1,6	1,3			247
77 52	115	0,3 - 1,0	0,8	0,5		247
77 72	115	0,3 - 0,8				247
78 03/13	125	0,2 - 1,6	1,0			241
78 03	140	0,2 - 2,1	1,2			242, 243
78 23	125	0,2 - 1,0	0,6			241
78 31/41	125	0,2 - 1,0				241
78 61/71	125	0,2 - 1,6	1,2			241
78 61	140	0,2 - 2,1	1,4			242, 243
78 81/91	125	0,2 - 1,6	1,2	0,6		241
79 02	120	0,2 - 1,4	1,0	0,6		244
79 02	125	0,2 - 1,7	1,3	0,7		244
79 12	125	0,3 - 1,7	1,3	1,0	0,6	244
79 22	120	0,1 - 1,3	0,8			244
79 22	125	0,1 - 1,7	1,0			244
79 32	125	0,2 - 1,5	1,1	0,6		244
79 42	125	0,1 - 1,5	0,8			244
79 52	125	0,2 - 1,3	0,9	0,5		244
79 62	125	0,1 - 1,3	0,8			244
99 0	200		1,8	1,4		76
	220		2,4	1,6		76
	250		2,4	1,6		76
	280		2,8	1,8		76
	300		3,1	1,8		76
99 1	250		3,3	1,8		77
	300		3,8	2,0		77

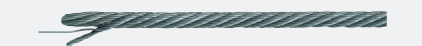
Wire classes

	Material examples	Type of wire	Tensile strength		
			N/mm ²	kp/mm ²	
	Copper, plastics	soft	220	22	
	Nail, wire pin	medium-hard	750	75	
	Wire rope strand, steel wire	hard	1800	180	
	Spring steel wire	piano wire	2300	230	

Note

The maximum values always indicate the performance limit under the most favourable cutting conditions, when the wire is placed as near as possible to the joint.

Structure of article number



Example of the item number on the pliers handle

Basic model e. g. KNIPEX Cobra® Hightech Water Pump Pliers	Style e. g. straight	Finish e. g. head polished, handles with multicompo- nent grips	Length e. g. 250 mm	Accessory e. g. Tethered- Tools- Programm
87	0	2	250	T



Safe working: very stable tether attachment, firmly welded to the handle grip for attaching a safety cord or adaptor sling

Head / handles

0

Pliers black
atramentized,
head polished



1

Head polished,
handles plastic
coated

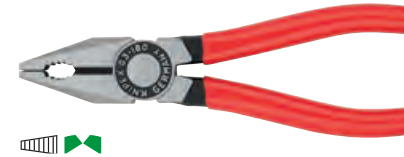

2

Head polished,
handles with
multi-component
grips



3

Pliers chrome
plated, handles
plastic coated



4

Pliers chrome plated



5

Pliers chrome
plated, handles with
multicomponent
grips

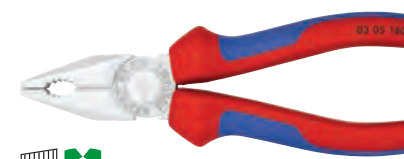

6

Pliers chrome plated,
handles insulated with
multi-component grips,
VDE-tested
DIN EN / IEC 60900

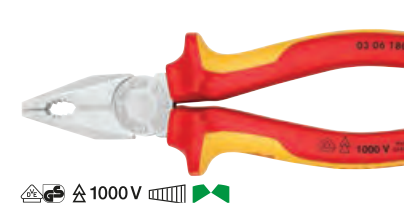



































































7

Pliers chrome plated,
handles with dipped
insulation, VDE-tested
DIN EN / IEC 60900



Pictograms

	Packing unit		Trapezoid indent crimp		Internal circlip
SB	Carded pliers		W-crimp		External circlip
BK	Pliers in a blister		F-crimp narrow		Retaining ring, straight
ESD 	Electrostatic discharging, dissipative		Hexagonal crimp		Retaining ring, diagonal
	Insulated according to IEC 60900, usable up to 1000 V AC/1500 V DC		Square crimp		Grip ring
	VDE tested, also in compliance with GPSG (Equipment and Product Safety Act)		Tyco crimp		Flat jaws
	Cu- + Al-multi-conductor cable, solid and multi-stranded		Western crimp		Flat and pointed jaws
	Wire rope		Trapezoidal crimp front		Half-round jaws
	Ribbon cable		Hexagon		Round jaws
	Steel wire armoured cable (SWA)		Hexagonal screw		Angle
	ACSR cable		Slotted screw		Smooth gripping surfaces
	Soft wire		Cross recessed screw		Smooth-serrated gripping surfaces
	Medium hard wire		PlusMinus cross recessed screw		Knurled gripping surfaces
	Hard wire		Pozidriv cross recessed screw		Cross-hatched, knurled gripping surfaces
	Piano wire		Torx		Centre cutter
	Square crimp automatic		With driving square 3/8"		Cutting edges with bevel
	Hexagonal crimp automatic		With driving square 1/2"		Cutting edges with small bevel
	Four mandrel crimp		Internal square 3/8"		Cutting edges with very small bevel
	Mandrel crimp		Internal square 1/2"		Cutting edges without bevel
	Trapezoid crimp		Hexagonal socket		For flush cut of soft materials
	Oval crimp		12-point		Mechanically tested in accordance with the Equipment and Product Safety Act
	F-crimp		With opening spring		Conforms to a European directive
	Mandrel crimp narrow		With lead catcher		WEEE marking (Waste Electrical and Electronic Equipment Directive)

Registered Trademarks of the companies

Con-Pearl®	friedola TECH GmbH
gesis®	Wieland Electric GmbH
Kapton®, KEVLAR®	E. I. du Pont de Nemours and Company
L-BOXX®	Sortimo International GmbH
Mini-Fit®, Micro-Fit™	Molex® Inc.
MC®	Multi-Contact AG
Phillips®	Phillips Screw Company
Pozidriv®	European Industrial Service Ltd.
Radox®	HUBER+SUHNER AG
Scotchlok™	3M
Solarlok®	Tyco Electronics
systemainer®	TANOS GmbH
Torx®	Acument Global Technologies, Inc.
WD-40®	WD-40 Company



KNIPEX-Werk
C. Gustav Putsch KG

42337 Wuppertal

Tel +49 202 47 94-0

Fax +49 202 47 74 94

info@knipex.com
www.knipex.com